

EXECUTIVE PRO Precisa 360 EP

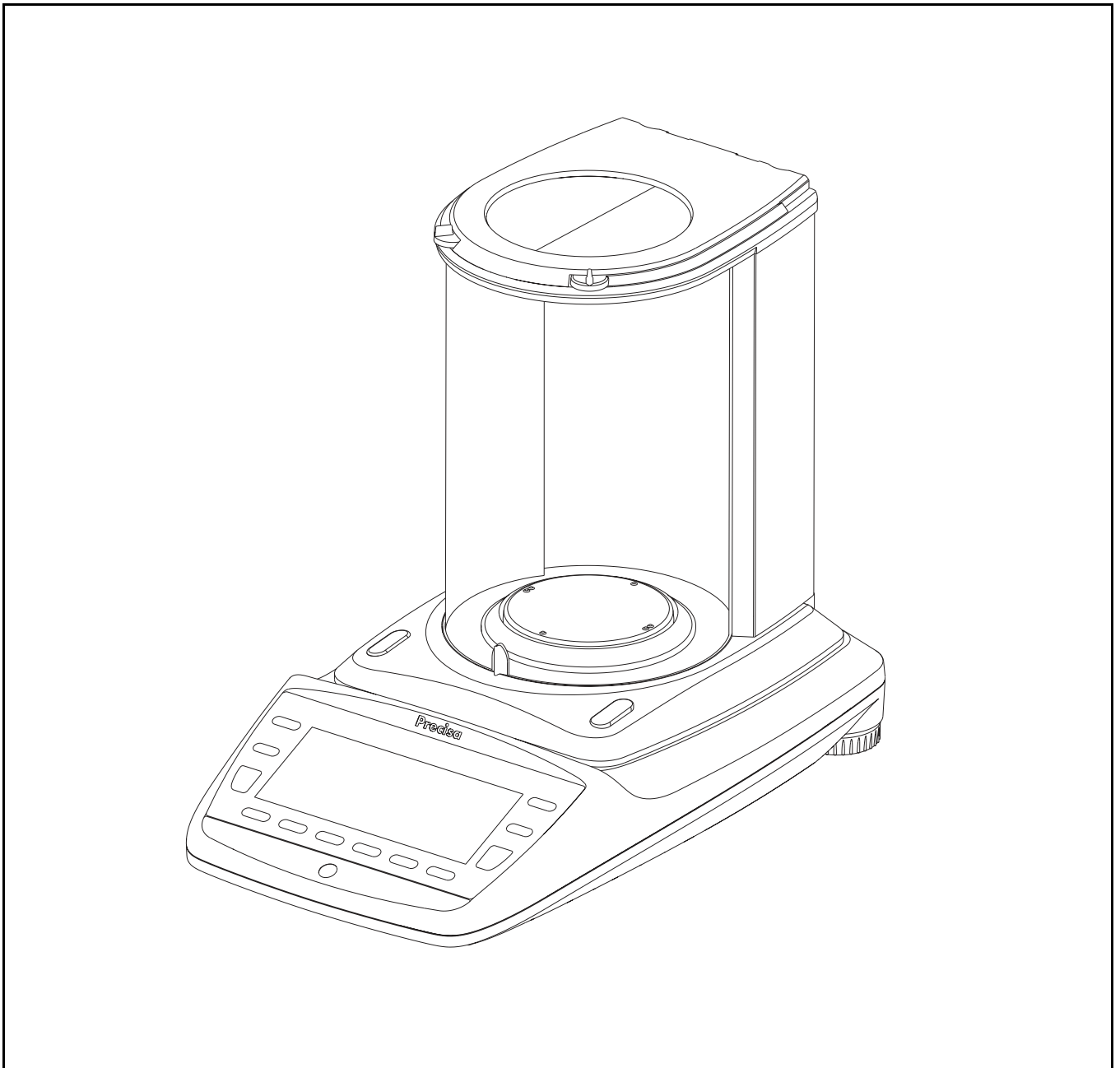

Operating Instructions

Identification

Customer service

Precisa Gravimetrics AG
Moosmattstrasse 32
CH-8953 Dietikon
Tel. + 41-44-744 28 28
Fax. + 41-44-744 28 38
email service@precisa.ch

<http://www.precisa.com>

Refer to our website for information about local customer service centers and details of their addresses.

Copyright

These operating instructions are protected by copyright. All rights reserved. No part of the operating instructions may be reproduced, processed, duplicated or published in any form by photocopying, microfilming, reprinting or other process, in particular electronic means, without the written agreement of Precisa Gravimetrics AG.

© Precisa Gravimetrics AG, 8953 Dietikon, Switzerland, 2010.

1 Overview

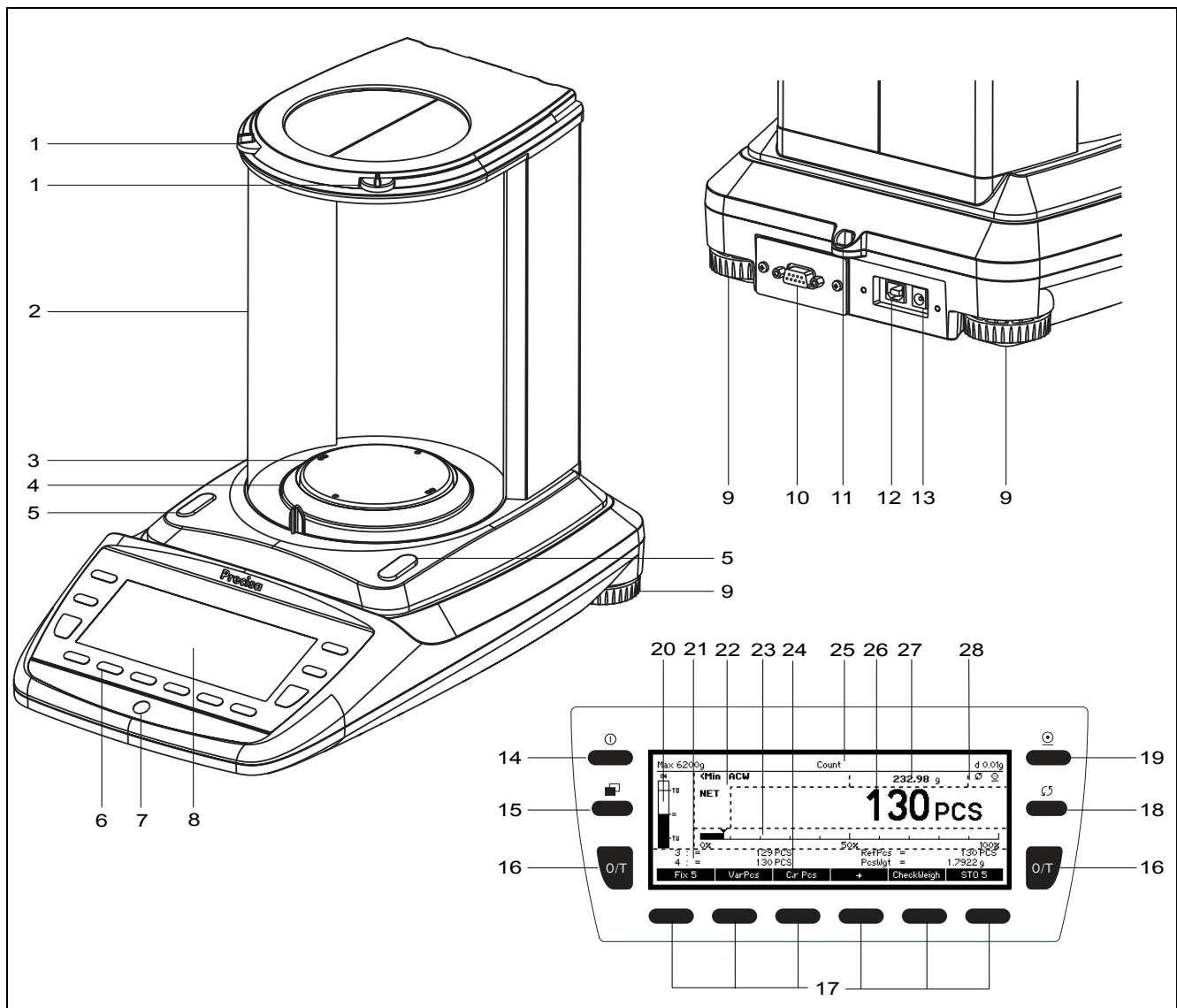

No.	Description	Section / Page	No.	Description	Section / Page
1	Top draft shield opening		14	On/Off key	
2	Draft shield		15	Menu key	
3	Weighing pan		16	Tare / Zero key	
4	Protective ring		17	Soft keys	
5	Sensor for side draft shield opening		18	Rotate key	
6	12-key control panel		19	Print key	
7	Levelling bubble		20	CheckWeigher	
8	Display		21	Info Page area	
9	Adjustable feet		22	Notice area	
10	Serial interface, DB9 socket		23	Capacity indicator	
11	Mechanical anti-theft protection		24	Function bar	
12	USB device connector for connection to PC		25	Headline	
13	Connecting socket for power adapter		26	Primary display	
			27	Secondary display	
			28	Activita area	

2 Inspection and assembly

Inspect delivery for complete supply immediately on unpacking all components.

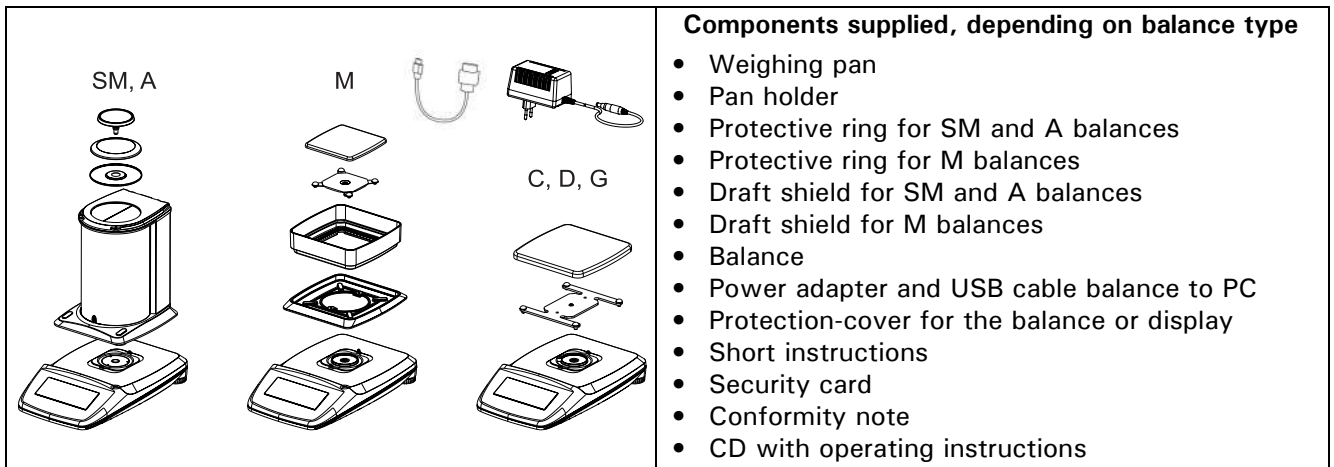

The balance is delivered in partly dismantled condition. Assemble the individual components in the following sequence:

- Install the draft shield as well or the protective ring with the two screws supplied
- Place the weighing pan in position
- Insert the power adaptor cable plug into the socket at the rear of the balance

! NOTE

A screwdriver is required for assembly.

All parts must fit together easily. Do not apply force. Precisa Customer Service will be pleased to help you with any problems.

3 Below-balance weighing

Objects which, because of their size or shape, cannot be put on the scale, can be weighed by means of below-balance weighing.

Proceed as follows:

- Turn off the balance.
- Remove the weighing pan and the pan holder then turn the balance up side down.
- Push the metal-cover (1) on the floor of the balance to one side.
- Hang a small hook (available as an accessory, see chapter 4 "Accessories") into the aperture (3) of the now visible metal casting (2).
- Place the balance over an opening.
- Replace the pan holder and the weighing pan.
- Level the balance (see chapter 3.6 "Levelling")
- Switch on the balance.
- Hang the object to be weighed on the hook and carry out the weighing.

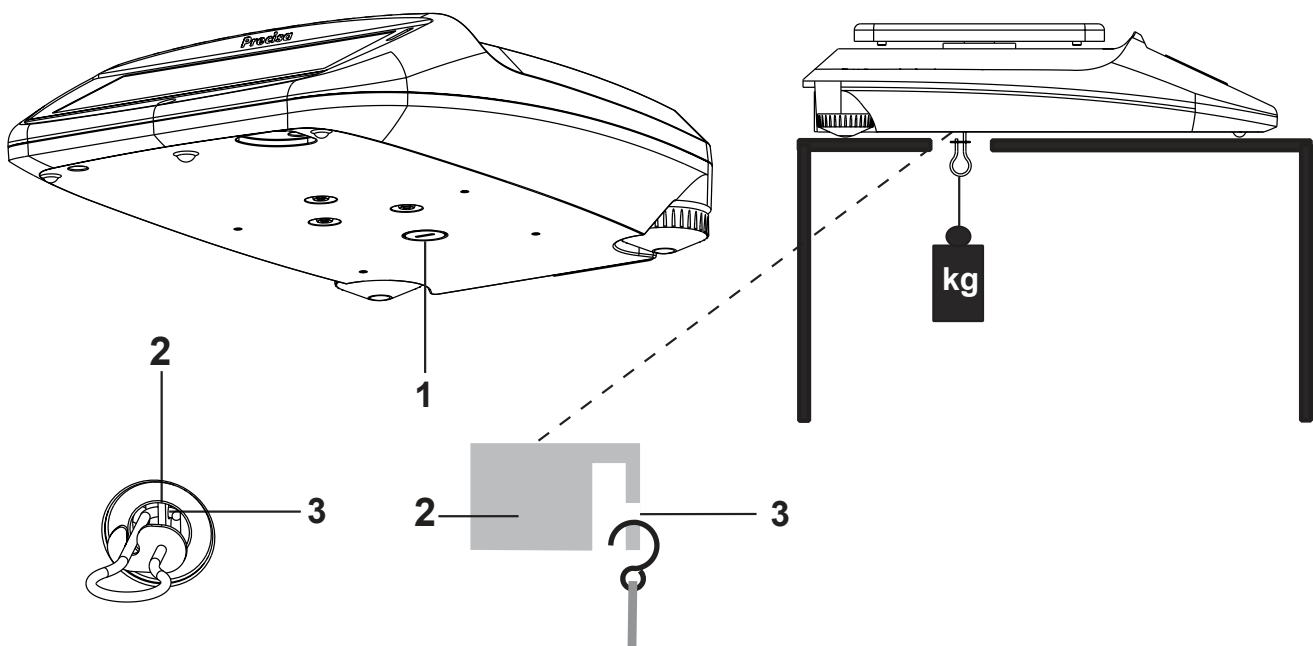

⚠ CAUTION

Take care that the hooks used for the below-balance weighing are stable enough to hold the goods which you wish to weigh.

ⓘ NOTE

Take care that no dirt or moisture can get into the balance with the weighing pan removed.
After completing the below-balance weighing, the opening in the floor of the balance must be closed again (dust protection).

4 Accessories

Accessorie	Article number
Draft shield 360 automatic for 0.01mg and 0.1mg balances, height 180mm	350-8658
Draft shield 360 manual for 0.01mg and 0.1mg balances, height 260mm	350-8659
Draft shield 360 manual for 0.01mg and 0.1mg balances, height 180mm	350-8660
Draft shield 320 XT for 0.01mg and 0.1mg balances, height 260mm	350-8517
Draft shield 320 XB for 0.01mg and 0.1mg balances, height 260mm requires adapter for 1mg, 0.01g, 0.1g and 1g balances*	350-8519
Draft shield 320 XB for 0.01mg and 0.1mg balances, height 180mm requires adapter for 1mg, 0.01g, 0.1g and 1g balances*	350-8518
*adapter for 1mg, 0.01g, 0.1g and 1g balances	350-7402
Draft shield mg, glass with cover	320-8504
Density kit for 0.01mg and 0.1mg balances Container size Ø 75mm, height 100mm	350-8515
Density kit for solids only (w/o Glass body and Hook) for 0.01mg and 0.1mg balances Container size Ø 75mm, height 100mm	350-8556
Glass body 10ccm for density determination of liquids	350-7054
Downholder for samples with density < 1 g/cm ³	350-7194
Animal weighing bowl complete for 0.01g, 0.1 and 1g balances	350-8551
Diamond weighing pan	350-8322
Hook for weighing below the balance	350-8527
Dust cover 360 for the whole balance, set of 20 pieces	350-8663
Data cable DB9 Male / DB9 Female (PC), 1.5m	350-8672
Data cable DB9 Male / DB25 Male (Printer), 1.5m	350-8673
Slide-in modules	Article number
USB Host	350-8665
Ethernet wired	350-8666
Ethernet wireless	350-8667
Bluetooth	350-8668
RS 485	350-8669
PS2 Female & RS 232 DB9 Female	350-8670

Additional SmartBox® Applications, Precisa BUS accessories, further special accessories and options on demand.

■ Contents

1	Overview	2	9.3	The Settings Menu	23
2	Inspection and assembly	3	10	The Configuration	24
3	Below-balance weighing	4	10.1	Setup Configuration Menu	24
4	Accessories	5	10.1.1	The Setup Configuration Menu	24
5	Safety Instructions and Conformity	8	10.2	Configuration - Weighing parameters	25
5.1	Conformity	8	10.3	Configuration - Calibration	25
5.2	Safety Instructions	8	10.4	Configuration - Protocol	26
6	Setup	9	10.4.1	Configuration - Protocol - Autostart	27
6.1	Unpacking the Balance	9	10.4.2	Configuration - Protocol - Mode	27
6.2	Transport and Shipping	9	10.4.3	Configuration - Protocol - Value format	28
6.3	Storage	9	10.4.4	Configuration - Protocol - Header/Footer (common items)	30
6.4	Choosing a Suitable Location	9	10.5	Configuration - Interface	33
6.5	Connecting the Balance to the Mains	10	10.6	Configuration - Device settings	34
6.6	Levelling	10	10.7	Configuration - Date/Time	34
6.7	Calibration of the Balance	10	10.8	Configuration - Minimal sample weight	35
6.8	Dual Range and Floating Range Balances	11	10.9	Configuration - Draft shield	35
6.9	Standardized Balance	11	10.9.1	Configuration - Draft shield - Settings	36
6.10	Switching on the Balance	11	10.10	Configuration - Properties	37
6.11	Auto-Standby Mode	11	11	The Administrator and the User Profiles	38
7	Discover the Capabilities of the New Series 360 EP	12	11.1	Resetting to the Factory Configuration	38
7.1	1st Step	12	11.2	The Administrator Menu	38
7.2	2nd Step	12	11.2.1	Administrator - Define user	39
7.3	3rd Step	14	11.2.2	Administrator - Define administrator	40
8	Operation	15	11.2.3	Administrator - Theft protection	40
8.1	The Keypad	15	12	Applications and Functions	42
8.1.1	Functions of the Keys if Operated in an Application	15	12.1	Enabling and Disabling Applications	42
8.1.2	Functions of the Keys if Operated in a Menu	16	12.2	Power Functions	44
8.1.3	Soft Key Functions for Navigation and Data Entry	16	12.2.1	Power Function: CheckWeigher	44
8.1.4	Soft Keys and Soft Key Assignments	16	12.2.2	Power function: Statistics	45
8.2	The Display (as it appears during a running application)	17	12.2.3	Power Function: Minimal sample weight	51
8.2.1	Info Pages and Info Fields	18	12.2.4	Power function: Identification	54
8.3	Navigating in a Context Menu of an Application	18	12.3	Utilities	61
8.4	Numerical Data Entry	20	12.3.1	Utility: Soft keys	61
8.5	Text Data Entry	20	12.3.2	Utility: Info fields	62
8.6	The Info window	21	12.3.3	Utility: Protocol	63
9	The Home Screen	22	12.4	Applications	66
9.1	The Applications Menu	22	12.4.1	Application: Weighing	66
9.2	The User Menu	23	12.4.2	Application: Piece Counting	67
			12.4.3	Application: Percent Weighing	68
			12.4.4	Application: Units Conversion	69
			12.4.5	Application: Dynamic Weighing	71
			12.4.6	Application: Automatic Repeatability Test ART	72
			13	Data Transfer	73
			13.1	Connection scheme	73
			13.2	Remote control-commands	74
			13.2.1	Examples for the remote control	75
			14	Maintenance and Servicing	76

- 14.1 Calibration..... 76**
- 14.1.1 External Calibration..... 76
- 14.1.2 External Calibration with Freely Selectable Weight..... 76
- 14.1.3 Internal calibration..... 77
- 14.1.4 Automatic Calibration 77
- 14.2 Software Update 77**
- 14.3 Cleaning..... 78**
- 14.4 Error Messages 78**
- 14.4.1 Notes on Correcting Faults 78
- 15 Additional Information..... 80**

5 Safety Instructions and Conformity

5.1 Conformity

The device has been manufactured and tested in accordance with the standards and directives set out in the enclosed certificate of conformity.

5.2 Safety Instructions

- When using the device in surroundings with increased safety requirements, the corresponding regulations must be observed.
- The device may only be operated with the included power adaptor or power cable.
- Be sure to hold the plug, not the cable, when disconnecting the device from an electrical outlet.
- If the power cable, the power adaptor or its cable is damaged, unplug the device immediately from the electrical outlet and keep it from inadvertent operation. The device may only be operated with a power adaptor or a power cable in perfect conditions.
- If there is any reason to believe that it is no longer possible to operate the device without danger, it must be immediately unplugged from the electrical outlet and kept from inadvertent operation.
- In carrying out maintenance work, it is essential to heed the instructions in the chapter "Maintenance and servicing" of the operating instructions.
- Do not operate the device in an area subject to explosion risks or caustic atmospheres.
- Take care when handling with liquids, that no liquid is split into the inside of the balance, on connections of the device, on the power cable or the power adaptor. Should this although happen, unplug the device immediately from the electrical outlet and keep it from inadvertent operation. The device may only be operated again after a re-check made by a Precisa service technician.
- The device may only be used for weighing of solid materials, of liquids filled into secure containers, and for running applications designed especially for the device (e.g. animal weighing or density determinations).
- Do not exceed the maximum permissible load of the balance.
- When using the device in combination with other appliances made by Precisa as well as with appliances produced by other manufacturers, the current regulations for the safe use of the relevant attachments and their application in accordance with instructions must always be observed.

DANGER

Before connecting the device to the mains, be sure that the operating voltage stated on the device and on the power adaptor or power cable agrees with the local mains voltage. If it doesn't, the equipment must not be connected to the mains at all! In this case contact the Precisa Customer Service.

NOTE

If any damage or injury occurs, liability and responsibility rest with the user.

6 Setup

6.1 Unpacking the Balance

The balances are delivered in an environmentally-friendly package, specifically developed for this precision instrument, which provides optimum protection for the balance during transportation.

! NOTE

Retain the original packaging in order to avoid transportation damages when shipping or transporting the balance and to allow the balance to be stored in the best conditions if it is out of operation for an extended period.

In order to avoid damage, attention must be given to the following points when unpacking the balance:

- Unpack the balance carefully. It is a precision instrument.
- When outside temperatures are very low, the balance should first be stored for some hours in the unopened transport package in a dry room at normal temperature, so that no condensation settles on the balance when unpacking.
- Check the balance immediately after unpacking for externally visible damage. If you should find transport damage, please inform your Services representative immediately.
- If the balance is not to be used immediately after purchase but only at a later time, it should be stored in a dry place where fluctuations in temperature are as low as possible (6.3 "Storage").
- Read through these operating instructions, even if you already have experience with balances, before you work with the balance and pay attention to the safety recommendations (5 "Safety Instructions and Conformity").

6.2 Transport and Shipping

Your balance is a precision instrument. Treat it with care.

Avoid shaking, severe impacts and vibration during the transportation.

Take care that there are no significant temperature fluctuations during the transportation and that the balance does not become damp (condensation).

! NOTE

The balance should preferably be dispatched and transported in the original packaging to avoid transportation damage.

6.3 Storage

If you would like to take the balance out of service for an extended period, disconnect it from the electricity supply, clean it thoroughly (14.3 "Cleaning") and store it in a place which meets the following conditions:

- No violent shaking, no vibrations
- No significant temperature fluctuations
- No direct solar radiation
- No moisture

! NOTE

The balance should preferably be stored in the original packaging, since this provides optimum protection for the balance.

6.4 Choosing a Suitable Location

The balance location must be chosen in such a way as to guarantee perfect operation of your balance, so that the allowable ambient conditions and prerequisites are met and maintained:

■ 6 Setup

- Put the balance on a solid, firm and preferably vibration-proof, horizontal base
- Make sure that the balance cannot be shaken or knocked over
- Protect from direct solar radiation
- Avoid drafts and excessive temperature fluctuations

! NOTE

With difficult conditions (where the balance may be easily shaken or subject to vibration) the balance can nevertheless provide accurate results through suitable adjustment of the stability control (see chapter 10.2 "Configuration - Weighing parameters").

6.5 Connecting the Balance to the Mains

The following safety recommendations must be observed when connecting the balance to the mains:

! DANGER

The balance may only be operated with the power adaptor supplied.

Check before connecting the power adaptor to the mains supply that the operating voltage stated on the balance or on the power adaptor agrees with the local mains voltage.

If the operating voltage is not the same as the mains voltage, the balance or the power adaptor must on no account be connected to the mains supply. Contact the Customer Service.

6.6 Levelling

To function properly, the balance must be precisely horizontal.

The balance is fitted with one spirit level and two adjustable feet for level-control, with the aid of which it is possible to compensate for small height differences and/or unevennesses in the surface on which the balance is standing.

The two screw feet must be adjusted so that the air bubble is precisely in the centre of the sight glass of the bubble level.

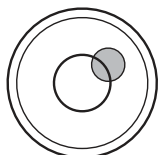

Incorrect

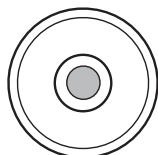

Correct

! NOTE

In order to get exact measurements, the balance must again be carefully levelled after each relocation.

6.7 Calibration of the Balance

Since the Earth's gravity is not the same everywhere, each balance must – in accordance with the underlying physical weighing principle – be adjusted to compensate for the gravity at each location. This adjustment process, known as "calibration", must be carried out on initial installation and after each subsequent relocation. In order to get exact measurements, it is recommended moreover, that the balance should also be calibrated periodically.

! NOTE

The balance must be calibrated on initial installation and after every relocation.

If you work in accordance with "Good Laboratory Practice GLP" observe the prescribed intervals between calibrations (adjustments).

Calibration is effected in the configuration menu. Depending on the balance model, this may be done externally, internally or automatically (see chapters 10.3 "Configuration - Calibration" and 14.1 "Calibration"). With the aid of the "Intelligent Calibration Mode" the balance can itself determine the size of the calibration weight, which enables an exact calibration with different size weights (in 10 g, 50 g, 100 g and 500 g steps, depending on implementation).

6.8 Dual Range and Floating Range Balances

With the Dual Range balances, weighing is always first carried out in the fine range, which is 10 times more precise. When the fine range is exceeded the balance switches automatically into the coarse range.

The Floating Range balances have a fine range (10 times more precise), which moves over the entire weight range. By pressing the tare key «T» the fine range can be called up as often as required over the entire weight range.

6.9 Standardized Balance

The standardized balances are provided with the EC/OIML certification or meet the local standardisation regulations.

The balance range and certain functions of the weighing output differ from the standard program in the case of the standardized balances – in accordance with the EC/OIML provisions.

! NOTE

If a circle appears in the main-display of a standardized balance, the indicated value is unstandardised.

In balances of class (1) the circle also stands for the warm-up phase.

Your Customer Service will be happy to assist you at any time if you have any questions on the standardization of the balance or on working with standardized balances.

6.10 Switching on the Balance

- Press «ON/OFF» to switch on the balance.

During the start-up sequence the balance executes a self check routine and stays, after about five seconds, ready in the same application before its last switching-off.

6.11 Auto-Standby Mode

The balance is equipped with an Auto-Standby mode, which can be activated or deactivated in the configuration menu.

If the Auto-Standby mode is activated, the balance automatically switches to Standby some time after the last weighing or key operation (current-saving function).

The delay before switching to Standby is defined in the configuration menu (10.2 "Configuration - Weighing parameters").

- Press any button or put on a weight in order to switch the balance from the Standby mode back to the normal operation mode again.

7 Discover the Capabilities of the New Series 360 EP

Work through the following example in order to explore some of the many new features of your new Precisa balance of the series 360 EP. Follow the instructions and keep observing the display.

Example:

As part of a modification kit, destined to 15 of your customers, you need to pack screws. Each kit is to consist of 126 screws. Since the screws are small and easy to get lost, you round the number up to 130 pieces, in order to keep possible trouble away from your customers. It although doesn't matter, if somebody gets one or two screws more or less. Let, for a better convenience, the balnce do the counting of the weighed packs. After all, for your statistics, you would like to know, how many screws you have packed and how accurate has been your working.

7.1 1st Step

Switch-on the balance:

- Press «**ON/OFF**»

During the start-up sequence the balance executes a self check routine and stays, after about five seconds, ready in the same application before its last switching-off.

In order to follow this example exactly, you may set the factory settings to the balance, but consider, that eventually made previous settings will be lost, wherefore a question window will ask you to confirm:

- Hold «**MENU**»
- Keep pressing {→} until „Settings“ in the headline is selected
- Press {▲} beneath the Administrator icon
- Keep pressing {↓} until the menu item „Set factory settings“ is selected and
- Press {↵} to confirm your selection
- Affirm the question „Set factory settings?“ by pressing {Yes}

Now select your language:

- Hold «**MENU**»
- Keep pressing {→} until „Settings“ in the headline is selected
- Press {▲} beneath the Configuration icon
- Keep pressing {↓} until the menu item „Device settings“ is selected
- Press {↵} to confirm your selection
- Keep pressing {↓} until the menu item „Language“ is selected
- Press {↵} to confirm your selection
- Keep pressing {↓} until in the list box your language is selected and
- Press {↵} to confirm your selection

Return to the application „Weighing“:

- Hold «**MENU**»
- Press {▲} beneath the Weighing icon

7.2 2nd Step

Switch to the application Piece Counting:

- Hold «**MENU**»
- Press {▲} beneath the piece counting icon

Now access the context menu of the just choosen application Piece Counting:

- Press «**MENU**»
- Keep pressing {↓} until the menu item CheckWeigher is selected
- Press {↵} to confirm your selection

Enable the CheckWeigher:

- Press {↵} to call up the list box with the options to modify the selected menu item CheckWeigher
- Press {↓} to select On
- Press {↵} to confirm your selection

Define the CheckWeigher:

- Press {↓} to select the menu item Nominal
- Press {↵} to start with the numerical data entry
- Press {12345} once and wait until the cursor will have moved one step rightwards
- Press {12345} three times and wait until the cursor will have moved one step rightwards
- Press {67890} five times and wait until the cursor will have moved one step rightwards
- Press {↵} to finish and save your input

Keep going on in order to define the CheckWeigher as follows:

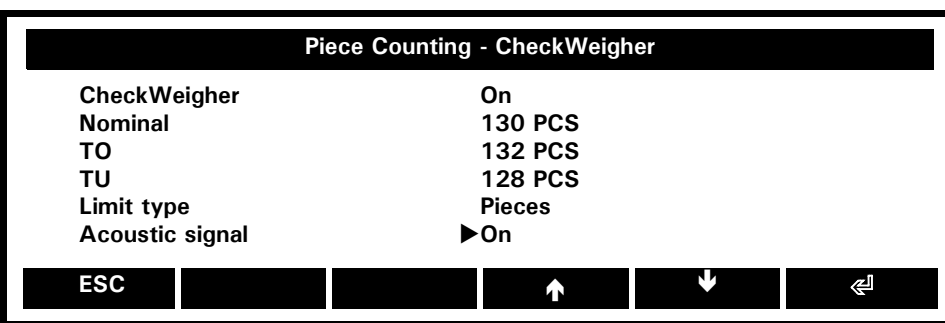

Return to the menu Piece Counting and switch the menu item Statistics:

- Press {ESC}
- Press {→} to open the next menu page (2/3) and
- Press {↵} to switch the selected menu item Statistics

Proceed now defining the Statistics as follows:

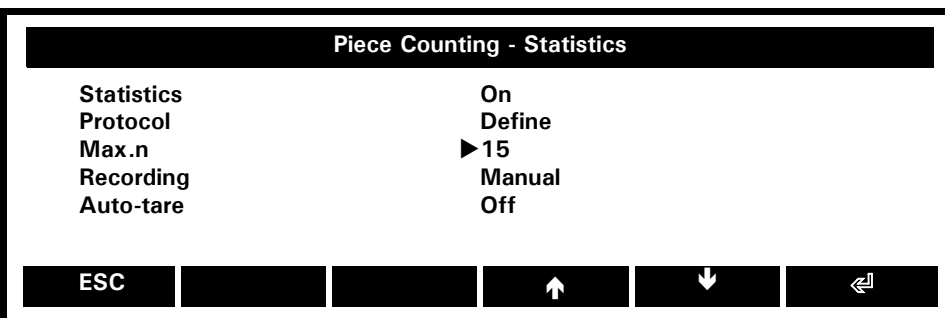

Return to the menu Piece Counting:

- Press {ESC}

Now switch the menu item Info fields:

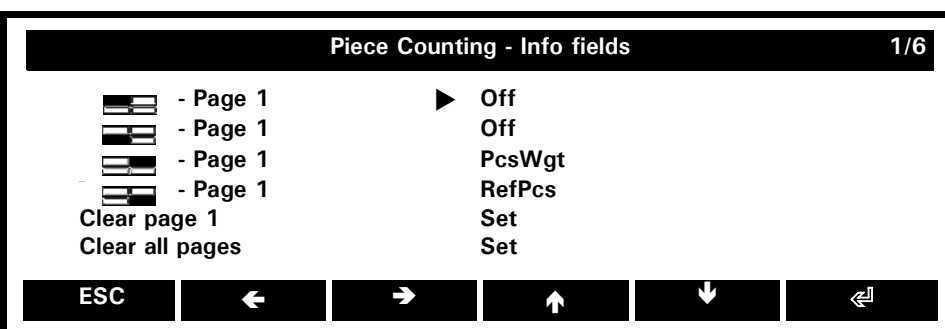

■ 7 Discover the Capabilities of the New Series 360 EP

As the CheckWeigher is already enabled, some basic additional information, such as PcsWgt and RefPcs, is going to be displayed in the info page. In our example we want to take a closer look over the shoulder of the balance and let it show us the last and the penultimate stored value too.

Assign the first two info page positions:

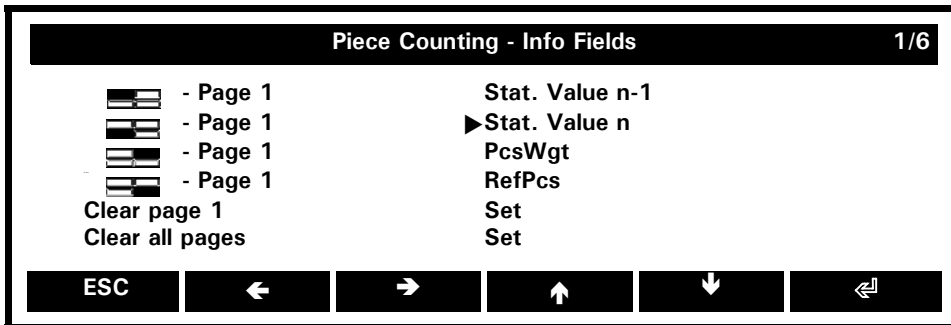

Return to the application Piece Counting:

- Press **{ESC}** twice

7.3 3rd Step

Put the container in which you want to count the screws on the weighing pan and tare the balance:

- Press **«0/T»**

At first, put exactly 5 screws into the container.

- Press **{5 PCS}**

The balance takes the quantity showing it in the primary display, while the weight is visible in the secondary display. There appears a rotate-symbol  on its right end which indicates the possibility of a content interchange between the primary and the secondary display by pressing **«ROTATE»**.

In the Info Area the balance is showing under "PcsWgt = " the calculated weight of one screw. Each time the number of pieces increases for at least three, the balance, being stable, re-calculates the reference weight of one piece. During this procedure appears a circle "O" on the left end of the primary display. As soon as it disappears, the new, just calculated piece weight is displayed in its info field. In order to allow the balance to count error-free, it is, at every first weighing-in, advisable to pause for some seconds each time the number of pieces doubles the last calculated one (thus in our case at 10, 20, 40 and 80).

As soon as the first lot of 130 pcs., with the graphic and acoustic aid of the CheckWeigher, is weighed-in, you may store it:

- Press **{STORE 1}**

The function **"STORE 1"** changes to **"STORE 2"**, **"STORE 3"** (observe both info fields on the left side of the info area). It stores and counts every weighing-in. Once the last weighing-in is stored, in our case the 15th, it changes to **"ENDED 15"**.

All statistic data are continuously refreshed and available during the entire procedure, as well individually displayed in the info area (remember the hold **«ROTATE»**-key for running over the info pages), as recallable with **{Show Stat.}** in an info window.

By pressing **{Clr Stat.}** you may anytime clear all statistic data and restart your weighing-in with the existing procedure settings.

Observe that as there are currently more available functions than softkeys, the above mentioned functions **{Show Stat.}** and **{Clr Stat.}** are in a second function bar. To call them up

- Press **{→}** first.





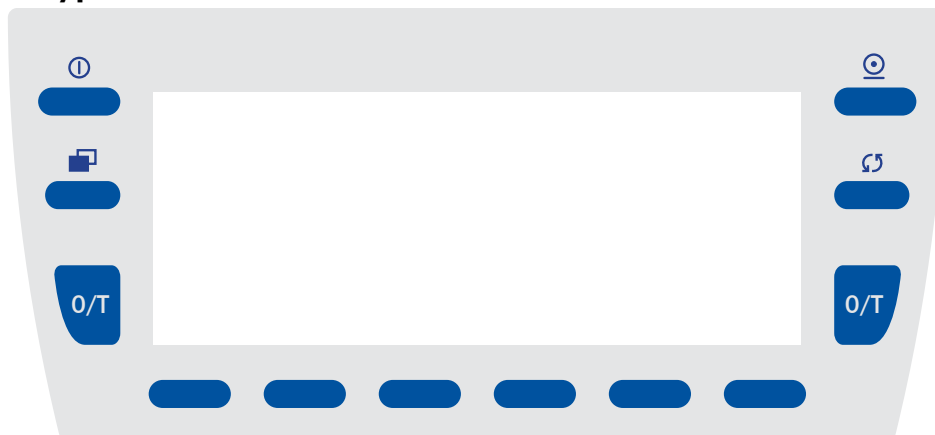

8 Operation

Even though your new balance allows you a very easy and highly intuitive working, you should read through the following operating instructions at full length to tap the full potential of the wide variety of features the balance disposes to facilitate your daily work.

8.1 The Keypad











8.1.1 Functions of the Keys if Operated in an Application

Key	Designation	Function in an Application
	«ON/OFF»	<ul style="list-style-type: none"> • Turns the balance on and off.
	«PRINT»	<ul style="list-style-type: none"> • Transmits the current measuring result or the content of an info window via interface to the peripherals.
	«MENU»	<ul style="list-style-type: none"> • Pressing leads to the context menu of the currently executed application. • Holding leads to the home screen from any point.
	«ROTATE»	<ul style="list-style-type: none"> • Pressing (only if adverted by the rotate symbol  in the activity area) exchanges the measuring results of the primary and the secondary display. • Holding calls up the next info page, continuously holding scrolls cyclically all info pages.
	«0/T»	<ul style="list-style-type: none"> • Pressing re-zeroes, respectively tares the balance. • Holding leads to the calibration menu.
	{SOFT KEY}	<ul style="list-style-type: none"> • Each of the six soft keys executes its assigned function, displayed in the function bar, straight above the key itself. If displayed, pressing {→} or {←} calls up further softkey-functions.

■ 8 Operation

8.1.2 Functions of the Keys if Operated in a Menu

Key	Designation	Function in a Menu
	«ON/OFF»	<ul style="list-style-type: none"> • Turns the balance on and off.
	«PRINT»	<ul style="list-style-type: none"> • Not functional.
	«MENU»	<ul style="list-style-type: none"> • Pressing leaves a menu. • Holding leads to the home screen from any point.
	«ROTATE»	<ul style="list-style-type: none"> • Pressing (only if adverted by the rotate symbol  in the activity area) calls up further soft key functions.
	«O/T»	<ul style="list-style-type: none"> • Not functional.
	{SOFT KEY}	<ul style="list-style-type: none"> • Each of the six soft keys executes its assigned function, displayed in the function bar, straight above the key itself. If available (displayed rotate symbol  in the activity area), pressing «ROTATE» calls up further soft key functions.

8.1.3 Soft Key Functions for Navigation and Data Entry

{←}	{left}	Moves the cursor left / scrolls pages
{→}	{right}	Moves the cursor right / scrolls pages
{↑}	{up}	Moves the cursor up / scrolls up lines
{↓}	{down}	Moves the cursor down / scrolls down lines
{▲}	{switch}	Switches the icon-figured function above
{↵}	{Enter}	Selects a menu item / finishes and saves an input
{ESC}	{Escape}	Quits an input without saving the changes
{ ←}	{Backspace}	Deletes the character located on the left side of the cursor („_“)
{DEL}	{Delete}	Deletes the character located above the cursor („_“)
{ABCDEFG}	{Symbol entry}	Keep pressing until the desired symbol appears, e.g. twice for „B“. The same procedure is valid for all symbol entry functions, e.g. {+ - * / = & %} or {67890}
{_}	{Space}	Interword separation

8.1.4 Soft Keys and Soft Key Assignments

A soft key is a soft-coded key, a button, located alongside the display, which performs a function displayed near or right above it in the function bar at that moment. (In opposition to that, a hard key is a hard-coded key, which performs just its firmly assigned function, e.g. «ON/OFF».) In each application you may assign a choice of various functions to the soft keys. If you assign more than 6 functions, a function {←} or {→} is displayed to switch from the current selection to the next.

8.2 The Display (as it appears during a running application)

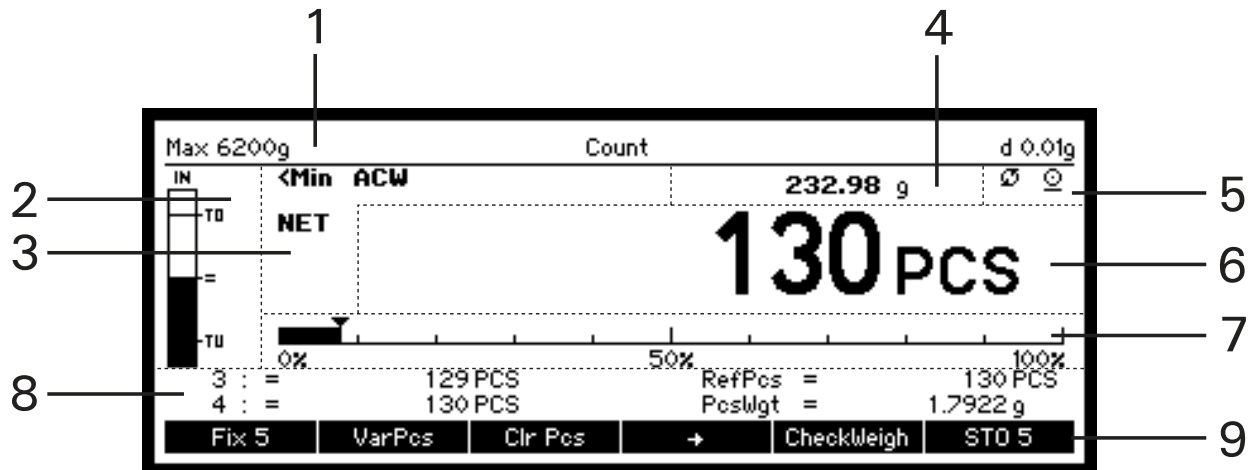













No.	Name of Display Section	Description
1	Headline	<ul style="list-style-type: none"> Names the running application with the weighing range and readability, or the running application and the system clock with date and time.
2	CheckWeigher	<ul style="list-style-type: none"> This smart aid supports you graphically, and by wish also acoustically, while weighing in.
3	Notice Area	<ul style="list-style-type: none"> Displays additional information about the measuring result, e.g. „NET“. Advises by displaying „<Min“ of a minimal weight underrun. Advises by displaying „ACW“ (Automatic calibration warning) the balance needs to be calibrated.
4	Secondary Display	<ul style="list-style-type: none"> Displays the measuring result, if chosen, in another unit, e.g. „PCS“. Observe that the unit symbol only appears at the time the measuring result is stable.
5	Activity Area	<ul style="list-style-type: none"> A displayed rotate symbol  adverts that by pressing «RO-TATE» the measuring results of the primary and the secondary display can be exchanged. A displayed print symbol adverts that the balance is busy transmitting the current measuring result or the content of an info window via interface to the peripherals. A displayed data entry symbol adverts that the balance is ready to receive data, either via interface (e.g. from a barcode reader) or manually.
6	Primary Display	<ul style="list-style-type: none"> Displays the measuring result in the chosen basic unit. Observe that the unit symbol only appears at the time the measuring result is stable.
7	Capacity Indicator	<ul style="list-style-type: none"> Displays graphically the rate of the currently utilised weighing range „0% ... 50% ... 100%“.
8	Info Page Area	<ul style="list-style-type: none"> Displays the selected info page, consisting of up to four assigned info fields available in the menu of the running application. This is to show information like tolerance limits when you are weighing in or various statistical data.
9	Function Bar	<ul style="list-style-type: none"> Displays straight above every single soft key its, at the moment assigned, function.

■ 8 Operation

8.2.1 Info Pages and Info Fields

There is a screen section called „Info Page Area“ to display application specific information. Each info page has 4 info fields: top left, bottom left, top right and bottom right. In an application, holding the «ROTATE» key calls up the next info page and continuously holding it scrolls cyclically all info pages.

Available info fields (quadrants) for displaying information on the info pages:

 Page 1 / Top left	 Page 1 / Top right
 Page 1 / Bottom left	 Page 1 / Bottom right
 Page 2 / Top left	 Page 2 / Top right
 Page 2 / Bottom left	 Page 2 / Bottom right
 Page 3 / Top left	 Page 3 / Top right
 Page 3 / Bottom left	 Page 3 / Bottom right
...	

Some applications already display the most usual information, but you may reconfigure the info pages at any time. Therefore switch the menu item Info fields in the context menu of the application and assign the info fields individually.

8.3 Navigating in a Context Menu of an Application

This chapter is to show how to navigate in a context menu of an application. For details about the applications themselves, see chapter 12 "Applications and Functions". Here, all settings are made just by way of example and are without further meanings.

Just selected, each application runs as preset, but for your convenience you may also modify its settings, i.e. customize it according to your requirements. This can be done directly in its context menus. Let's do this for example with the application Weighing:

- Press «MENU»

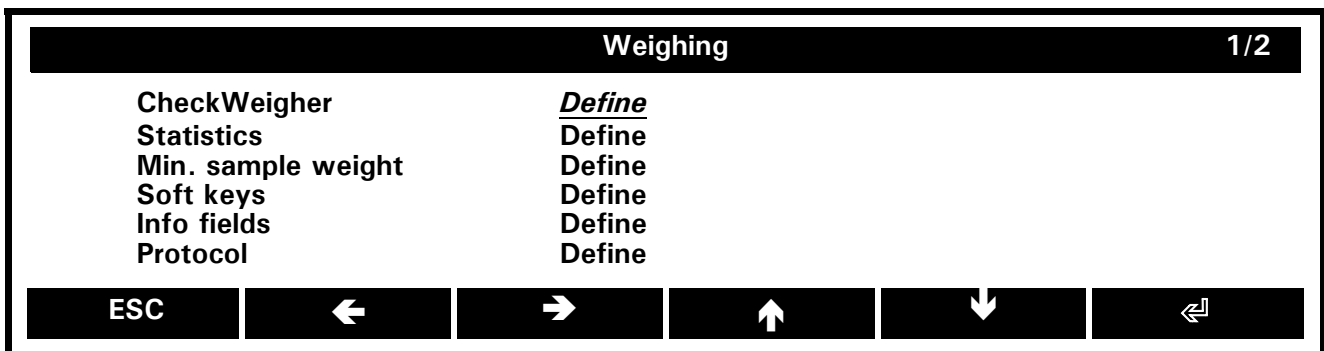

We are in the main level of the weighing context menu, where the headline names the running application (Weighing) and the function bar provides us with the needed navigation functions. Observe that the headline in a menu is black, while in an application it is white. In the central area are listed all menu items the application consist of. If there are more than 6 menu items available, they are shared to various pages which you may scroll by pressing {←} and {→}. The actual page and the number of pages are displayed at the right end of the headline, in our example „1/2“, i.e. page 1 of 2. The left column names the single items, while the right one allows us to select and define them one by one. At the moment, the menu item CheckWeigher is selected. To change the definitions of the statistics item

- press {↓} to select it and
- press {↵} to confirm your selection

Weighing - Statistics	
Statistics	<u>Off</u>
Protocol	Define
Max. n	100
Recording	Manual
Auto-tare	Off

ESC			↑	↓	E
-----	--	--	---	---	---

- Press {↓} to select „Protocol“ and
- Press {↵} to confirm your selection

Weighing - Statistics - Protocol	
Auto-print	<u>Off</u>
* Sample	Define
Result	Define

ESC			↑	↓	↵
-----	--	--	---	---	---

We reached the sublevel 3, as adverted by the headline which displays the entire path we have passed (Weighing - Statistics - Protocol).

To activate the already selected auto-print item

- press {↵} to confirm the selection

Weighing - Statistics - Protocol	
Auto-Print	▶ <u>Off</u>
* Sample	On
Result	Define

ESC			↑	↓	↵
-----	--	--	---	---	---

- Press {↓} to select „On“ in the list box and
- Press {↵} to confirm your selection

Weighing - Statistics - Protocol	
Auto-Print	<u>On</u>
Title ‚Statistics‘	On
* Sample	Define
Intermediate result	Off
Result	Define

ESC			↑	↓	↵
-----	--	--	---	---	---

The auto-print item results set on.

To leave a context menu

- Keep pressing {ESC} until you reach the running application.

■ 8 Operation

8.4 Numerical Data Entry

Sometimes you need to put in numerical data, e.g. defining a limit of tolerance. Let's do that in the CheckWeigher and reduce the under limit to 1.25% (with the balance still running the weighing application):

- Press «**MENU**» to enter the context menu
- Press {**↵**} to define the menu item CheckWeighing
- Keep pressing {**↓**} until the „2.50 %“ of the menu item TU is selected
- Press {**↵**} to change its numerical value

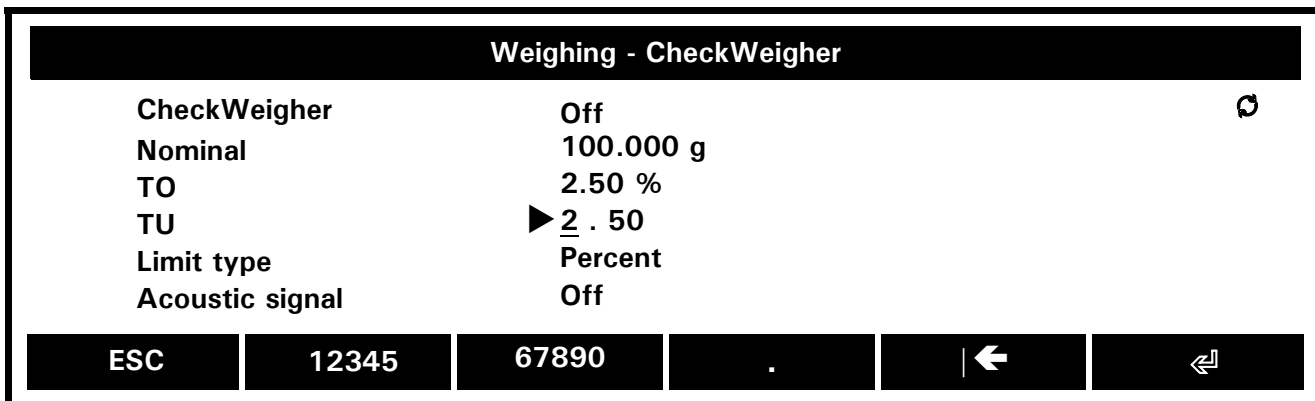

- Press {**12345**} once and wait until the cursor will have moved one step rightwards
- Press {**.**} and wait until the cursor will have moved one step rightwards
- Press {**12345**} twice and wait until the cursor will have moved one step rightwards
- Press {**12345**} five times and wait until the cursor will have moved one step rightwards

An eventual wrong entry you may correct with the backspace function {**|←**} which deletes the character located on the left side of the cursor („_“). By pressing «**ROTATE**» (observe the rotate symbol  in the upper right corner of the central area) it is possible to call up further editing functions, as {**←**} and {**→**} to position the cursor freely and {**DEL**} to delete the character located above the cursor:



Is the changing of the value completed

- Press {**↵**} to finish and save your input

8.5 Text Data Entry

Text and numerical data entries can be done the same way, as evident in the following example in which we are going to put in „Customer 5“ as an identification (with the balance still running the weighing application):

- Press «**MENU**» to enter the context menu
- Keep pressing {**→**} and {**↓**} until the menu item Identification is selected and
- Press {**↵**} to define it
- Press {**↵**} to define the menu item ID 1
- Press {**↓**} to select the menu item Name and
- Press {**↵**} to define it

Weighing - Identification - ID 1					
ID 1		Off			↻
Name	▶	ID 1			
Datatype		Alphanumeric			
ABCDEF	GHIJKL	MNOPQR	STUVWXYZ	←	↵

Doing text data entries, a wider range of additional soft key functions is available (observe the rotate symbol ↻ in the activity area and call them up by pressing «ROTATE»):

abcdef	ghijkl	mnopqr	stuvwxyz	←	↵
ESC	_	.,:;!@	_(){}[]	←	↵
ESC	12345	67890	+ - * / = & %	←	↵
ESC	←	→	DEL	←	↵

! NOTE

Executing text data entries, numbers put in with the soft key functions {12345} and {67890} act as characters, not as numeric values.

Is the text data entry completed

- Press {↵} to finish and save your input

8.6 The Info window

The Info Window is used to display large text information on the screen. You can press «PRINT» at any time to have a printout of the text in the info window.

Configuration - Properties					
<div style="border: 1px solid black; padding: 5px;"> <div style="display: flex; align-items: center;"> <div style="border: 1px solid black; border-radius: 50%; width: 20px; height: 20px; display: flex; align-items: center; justify-content: center; margin-right: 5px;">i</div> <div> <p>Content of Info Window</p> <p>Line 1</p> <p>Line 2</p> <p>Line 3</p> <p>Line 4</p> <p>Line 5</p> <p>Line 6</p> <p>Line 7</p> <p>Line 8</p> </div> </div> </div>					
ESC			↑	↓	

Pressing {↑} and {↓} scrolls the lines up and down, holding scrolls to the top and the bottom of the text. To exit the info window, press {ESC}.

9 The Home Screen

The home screen provides access to the various menus of the balance, which are listed in the white head-line, just the part which displays the currently selected position is black (either Applications, User or Settings).

9.1 The Applications Menu

In order to act as a highly versatile precision instrument, your balance is equipped with various applications, ready to switch, as soon as you access to the home screen.

- Hold «MENU» to switch the home screen.

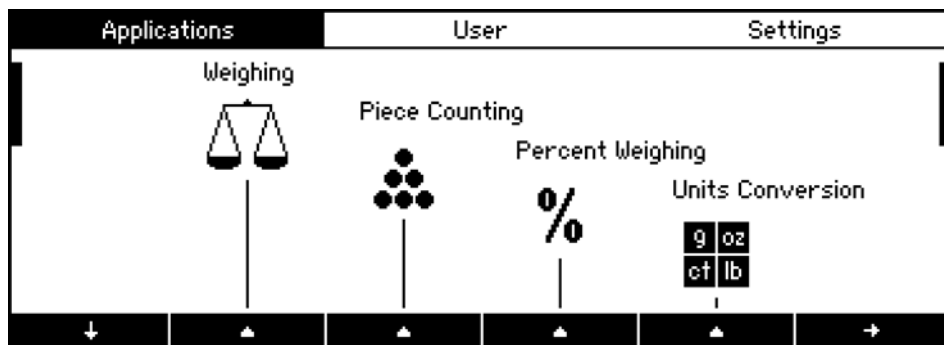

The first page of available applications is displayed. Observe the vertical scroll bars on the sides indicating that there are more applications from which to choose

- Press {↓} to scroll down the icon lines.

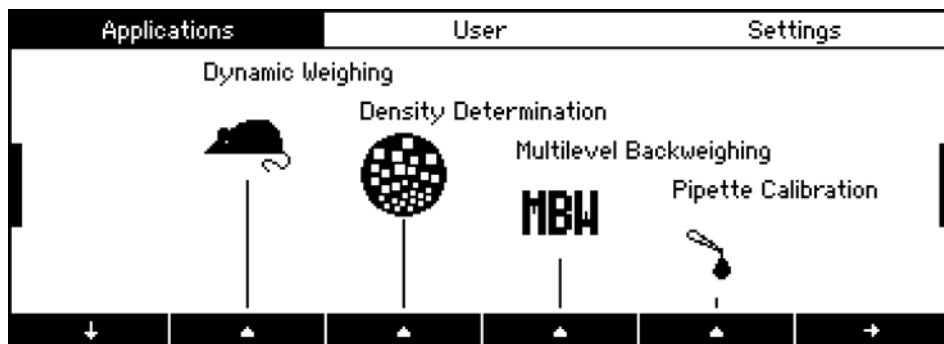

To return to the top line of icons

- Press {↓} again.

To choose an application, e.g. Weighing

- press the correspondent switch {▲}.

! NOTE

Holding «MENU» leads by default to the applications section of the home screen from any point. Should you wish to start in the user section by holding «MENU», just accede the settings section of the home screen, switch configuration and change the setting of the menu item „Home“, see also chapter 10.6 "Configuration - Device settings".

9.2 The User Menu

The user menu provides access to up to 8 different password protected user profile settings. Observe, that the user menu cannot be switched if no user profile is enabled. Learn more about defining user profiles in chapter 11.2.1 "Administrator - Define user"

- Hold «MENU» to switch the home screen
- Keep pressing {→} until the user menu is selected

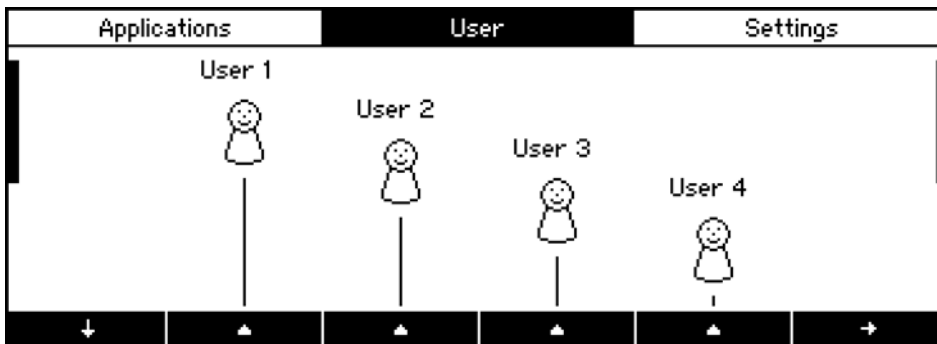

In case of more than four defined user profiles vertical scroll bars on the sides indicate that there are more user profiles from which to choose. As in the application menu, you may press {↓} to switch the second page and activate the particular user profile by pressing the correspondent {▲}.

English

9.3 The Settings Menu

The settings menu is where all balance settings can be done, such as defining the basic parameters, the administrator and user profiles, customizing applications or resetting to the factory configuration.

- Hold «MENU» to switch the home screen.
- Keep pressing {→} until the settings menu is selected

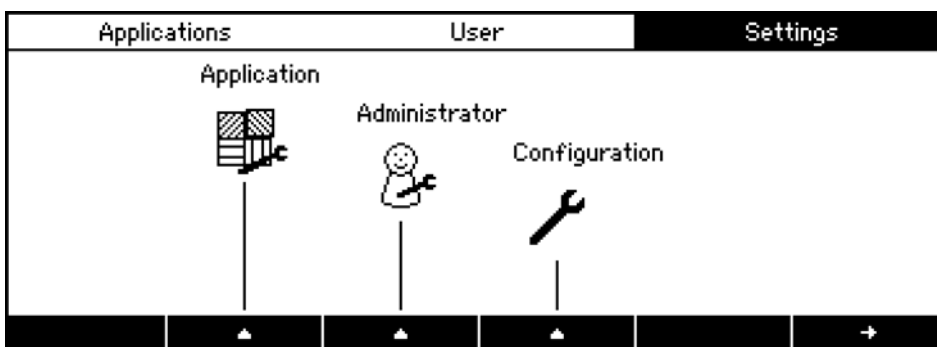

For particular information about all setting options, see the correspondent chapters 12 "Applications and Functions", 11 "The Administrator and the User Profiles" and 10 "The Configuration".

10 The Configuration

This section explains the structure of the configuration menu and its functions. The basic adjustment of the balance is defined in the configuration.

NOTE

Angle quoted menu items do not appear, unless in cooperation with particular settings.

10.1 Setup Configuration Menu

10.1.1 The Setup Configuration Menu

- Hold «MENU» to switch the home screen.
- Keep pressing {→} until the settings menu is selected.
- Press {▲} beneath the configuration-icon to switch the configuration menu.

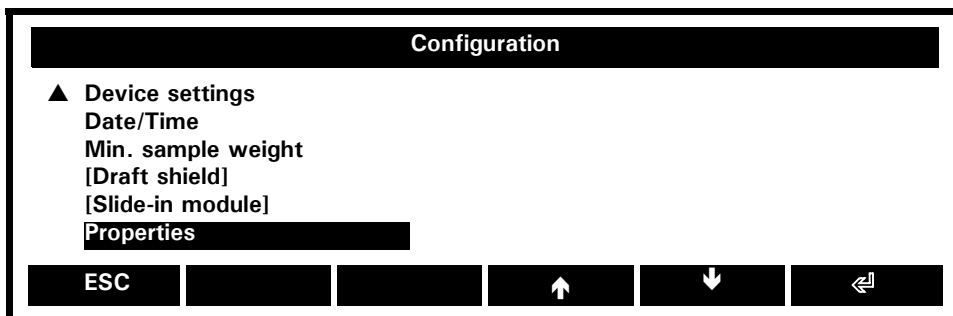
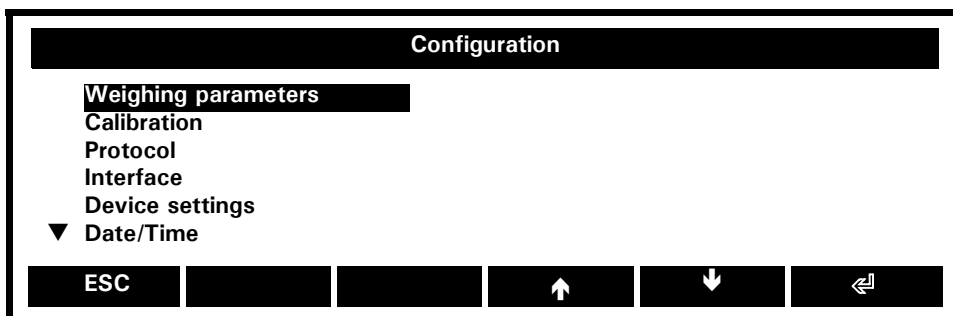

Weighing parameters:

General settings/parameters for the weighing system

Calibration:

General settings for the calibration

Protocol:

General settings for the protocol/printout

Interface:

General settings for the RS232/V24 interface to communicate with peripheral devices

Device settings:

General settings for the look-and-feel

Date/Time:

General settings for the date and time

Min. sample weight:

General settings for the minimal sample weight user-support during weighing

[Draft shield:]

(only available if the balance is equipped with an automatic draft shield)

General settings for the automatic draft shield

[Slide-in module:]

(only available if the balance is equipped with a slide-in module)

General settings for the slide-in module. For details refer to its operating instructions.

Properties:

Display and printout of all configuration settings

10.2 Configuration - Weighing parameters

Configuration - Weighing parameters	
Basic unit	►g
Refresh rate	Normal
Environment	Normal
Autostandby time	Off
Autozero	On
Quicktare	Off

ESC ↑ ↓ ↵

Basic unit: g, mg, kg, ..., baht

Unit in which the weighing results usually are displayed. Learn more in chapter 12.4.4 "Application: Units Conversion".

The balance can show results in different units, although, with some balances display is not possible in milligram or kilogram, because of the respective weighing range.

See the list of available units in chapter 15 "Additional Information".

Refresh rate: fast, normal, slow, extra slow

The value set defines the period after which each new measurement is displayed.

For the definition of this period, the quality of the balance location is crucial. The stability control must also be set appropriately, see next point „Environment“.

Environment: stable, normal, unstable

Adjust the balance to the quality of the balance location, see also chapter 6.4 "Choosing a Suitable Location".

Autostandby time: Off, 30 Seconds, 1 Minute, 5 Minutes, 30 Minutes

Defines the period of non-use before the balance automatically switches into the energy-saving mode.

The Autostandby only works with the automatic zero-correction enabled („Autozero“).

To re-start the balance, press any key, put a weight on the balance or execute a remote control command via the interface.

Autozero: On, Off

Automatic zero-correction.

The balance holds a stable zero (e.g. even with fluctuations in room temperature).

Quicktare: On, Off

The balance executes a fast tare, even at not yet stabilized weight.

10.3 Configuration - Calibration

For calibration of the balance, see chapters 6.7 "Calibration of the Balance" and 14.1 "Calibration". The setting depends on the balance model.

Configuration - Calibration	
Calibration mode	►Internal
[Calibration weight]	0.000 g
[Weight ID]	_____
[Automatic mode]	Time & Temperature
[Temperature diff.]	2 C
[Time]	06:00:00
Protocol	On

ESC ↑ ↓ ↵

■ 10 The Configuration

Calibration Mode: Off, External, Ext. user-def.weight, **Internal**, Automatic

- Calibration closed

- External calibration

- External calibration with a user-defined calibration weight, see „[Def.-Weight]“

- Calibration with the internal calibration weight

- Automatic calibration on time, temperature or time and temperature

[User-def.weight:] 0.000 g, n.nnn g.

(only available in Calibration Mode External Def.-Weight)

Defines an external calibration weight

[Weight ID:] _____

(only available in Calibration Mode External Def.-Weight)

Sets an alphanumeric identification to the external calibration weight

[Automatic Mode:] Time & Temperature, Temperature, Time

(only available in Calibration Mode Automatic)

- Automatic calibration on time and temperature

- Automatic calibration on temperature

- Automatic calibration on time

[Temperature:] 2 C

(only available in Calibration Mode Automatic)

Defines how much the temperature has to change to start the automatic calibration. Pre-set is a temperature change of 2. The unit is about degree Celsius.

[Time:] 06:00:00

(only available in Calibration Mode Automatic)

Defines the time of day on which to start the automatic-calibration

Protocol: On, Off

Executes, after a calibration, a printout of the calibration protocol

10.4 Configuration - Protocol

Just pressing «**PRINT**» transmits the current measuring result via interface to the peripherals. Setting up the protocol, you can

- define under what conditions this has to happen
- define the format of the value (measuring result) in the printout
- choose various additional information to be printed out.

The main screen to setup the protocol:

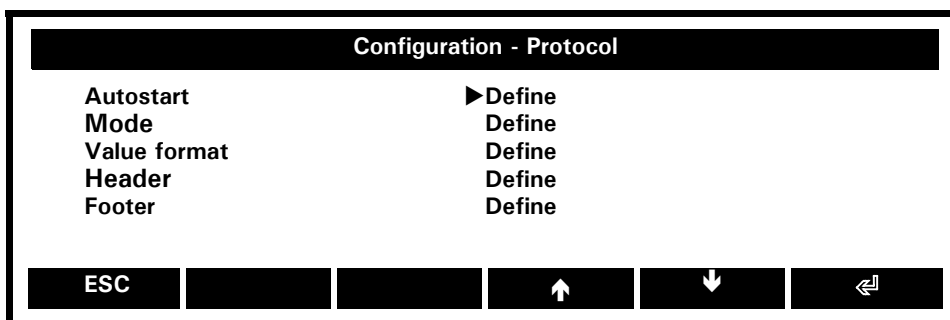

Autostart: Define

Defines the automatic start of the printout after the balance has been switched on. An '*' is displayed if the autostart is enabled

Mode: Define

Defines the mode of the printout, e.g. stable or after a loadchange, and so on

Value format: Define

Defines the format of the weight value in the printout

Header: Define

Defines the format of a header in the printout. An '*' is displayed if the Header is enabled

Footer: Define

Defines the format of a footer in the printout. An '*' is displayed if the Footer is activated

10.4.1 Configuration - Protocol - Autostart

Configuration - Protocol - Autostart	
Autostart	▶ Off
Delay	0.0 s
Limit	0.000g

ESC			↑	↓	↵
-----	--	--	---	---	---

Autostart: On, Off

Starts the printout automatically

[Delay:] 0.0 s

(only available with Autostart On)

Delaytime to start the automatic printout

[Limit:] 0.000 g

(only available with Autostart On)

Minimal weight to start the automatic printout

10.4.2 Configuration - Protocol - Mode

Configuration - Protocol - Mode	
Mode	▶ stable
[Limit]	0.000 g
[Delay]	1.0 s

ESC			↑	↓	↵
-----	--	--	---	---	---

Mode: Unstable, **Stable**, Loadchange, Continous, Time interval, Off

- Individual printout, each value any time
- Individual printout, stable value
- Printout after load changes
- Continuous printout after every integration time
- Continous printout with time basis
- No printout

[Limit:] 0.000 g

(only available with Mode loadchange)

Maximum weight for Mode loadchange

[Delay:] 1.0 s

(only available with Mode timebase)

Time of continous Mode timebase

10.4.3.2 Configuration - Protocol - Value format - Value

This setting is only available if the value format is set to „user defined“, see chapter 10.4.3 "Configuration - Protocol - Value format".

Configuration - Protocol - Value format - Value	
Sign	►-xxx.yy
Length	9
Decimals	0
Unit	5
Overload text	OL
Underload text	UL
<div style="display: flex; justify-content: space-between; border-top: 1px solid black;"> ESC ↩ → ↑ ↓ ↵ </div>	

Sign: -xxx.yy, - ___xxx.yy, -/+xxx.yy, -/+ ___xxx.yy

- Left oriented, with negative sign only
- Right oriented, with negative sign only
- Left oriented, with negative and positive sign
- Right oriented, with negative and positive sign

Length: 9

Length of value, e.g: 9 digits

Decimals: 0

Decimal places of value, e.g: 0 decimals places

Unit: 5

Length of unit, e.g: 5 characters

Overload text: OL

Text to indicate an overload condition, e.g: „OL“

Underload text: OL

Text to indicate an underload condition, e.g: „UL“

10.4.3.3 Configuration - Protocol - Value format - Position

This setting is only available if the value format is set to „user defined“, see chapter 10.4.3 "Configuration - Protocol - Value format".

In a printout, the measuring result, that in the menu is called „Value“, fills one line. The measuring result doesn't consist just of its numeric value, e.g.: „123.456“, but of up to 7 positions:

Configuration - Protocol - Value format - Position		1/2
Indicator *,o	►no. 1	
Indicator <, >	no. 2	
Value	no. 3	
Unit	no. 5	
Spacing 1	no. 4	
Spacing 2	Off	
<div style="display: flex; justify-content: space-between; border-top: 1px solid black;"> ESC ← → ↑ ↓ ↵ </div>		

Configuration - Protocol - Value format - Position		2/2
Spacing 3	Off	
<div style="display: flex; justify-content: space-between; border-top: 1px solid black;"> ESC ← → ↑ ↓ ↵ </div>		

■ 10 The Configuration

Indicator *,o: Off, no. 1, no. 2, no. 3, no. 4, no. 5

*Position of Indicator *,o, e.g.: 1st position*

Indicator <,>: Off, no. 1, no. 2, no. 3, no. 4, no. 5

Position of space holder 2, e.g: not used

Value: Off, no. 1, no. 2, no. 3, no. 4, no. 5

Position of value, e.g: 1st position

Unit: Off, no. 1, no. 2, no. 3, no. 4, no. 5

Position of unit, e.g: 3rd position

Spacing 1: Off, no. 1, no. 2, no. 3, no. 4, no. 5

Position of space holder 1, e.g: 2nd position

Spacing 2: Off, no. 1, no. 2, no. 3, no. 4, no. 5

Position of space holder 2, e.g: not used

Spacing 3: Off, no. 1, no. 2, no. 3, no. 4, no. 5

Position of space holder 3, e.g: not used

The following table is to illustrate the resulting printout at various position settings for the value format, without the indicators „*,o“ and „<,>“, which appear under particular conditions only:

Pos. no 1	Pos. no 2	Pos. no 3	Pos. no 4	Pos. no 5	Printout
Value	Space 1	Unit	not assigned	not assigned	+ 123.456_g
Space 1	Value	Space 2	Unit	Space 3	_ + 123.456_g_
Unit	Space 1	Value	not assigned	not assigned	g_ + 123.456
Space 1	Value	Space 2	Unit	not assigned	_ + 123.456_g

10.4.4 Configuration - Protocol - Header/Footer (common items)

As the menu header and the footer menus differ just in the item „Position“, both are treated in this chapter.

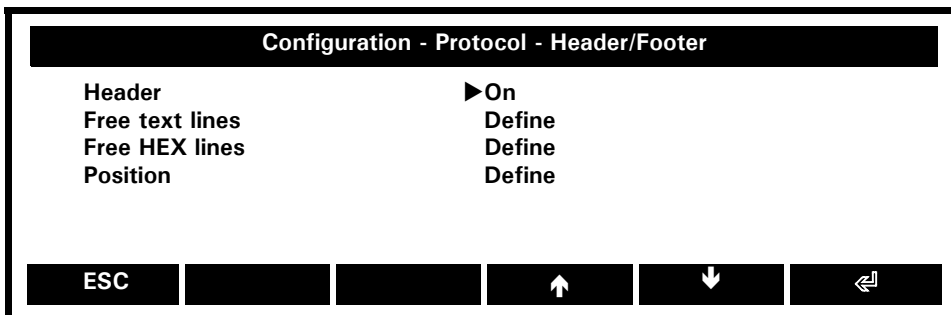

Header/Footer: On, Off

Header/Footer is enabled in printout

Free text lines: Define

Defines text lines for header/footer

Free Hex lines: Define

Defines hexadecimal output for header/footer

Position: Define

Defines positions in header/footer

10.4.4.1 Configuration - Protocol - Header - Free text lines

Configuration - Protocol - Header - Free text lines	
Text line 1	▶ ___
Text line 2	___
Text line 3	___
Text line 4	___
Text line 5	___
ESC	<input type="checkbox"/> <input type="checkbox"/> <input type="checkbox"/> <input type="checkbox"/> <input type="checkbox"/> <input type="checkbox"/>

The free text of the header may act as heading or a title:

Text line 1: ___

Defines free text line 1, e.g.: „Precisa Gravimetrics AG“

Text line 2: ___

Defines free text line 2, e.g.: „Moosmattstrasse 32“

Text line 3: ___

Defines free text line 3, e.g.: „CH-8953 Dietikon“

Text line 4: ___

Defines free text line 4, e.g.: „SWITZERLAND“

Text line 5: ___

*Defines free text line 5, e.g.: „*****“*

Configuration - Protocol - Footer - Free text lines	
Text line 1	▶ ___
Text line 2	___
Text line 3	___
Text line 4	___
Text line 5	___
ESC	<input type="checkbox"/> <input type="checkbox"/> <input type="checkbox"/> <input type="checkbox"/> <input type="checkbox"/> <input type="checkbox"/>

The footer free text might look e.g. as follows:

Text line 1: ___

Defines free text line 1, e.g.: „Measured at laboratory no.1“

Text line 2: ___

Defines free text line 1, e.g.: „according to regulation 1.2.“

Text line 3: ___

Defines free text line 1, e.g.: „supervised by S.Wander“

Text line 4: ___

Defines free text line 1, e.g.: „- - - - -“

Text line 5: ___

*Defines free text line 1, e.g.: „*****“*

10.4.4.2 Configuration - Protocol - Header/Footer - Free HEX lines

A HEX Line carries, according to ASCII, information in hexadecimal format, i.e. hexadecimal characters. A 41 (hex) would cause for example the printout of a line with the letter „A“ (which corresponds 41 (hex) ASCII). Of course writing text this way cannot be the real thing, for this purpose defining free text (chapter 10.4.4.1 "Configuration - Protocol - Header - Free text lines") is much more adequate and convenient too. The sense of this option is in fact the possibility to input ASCII control characters, e.g. 0A (hex) for LF (line feed) or 0D (hex) for CR (carriage return), or entire sequences of ASCII control characters. Such sequences are to control an output device, e.g. printer, and are discussed in its operation manual.

■ 10 The Configuration

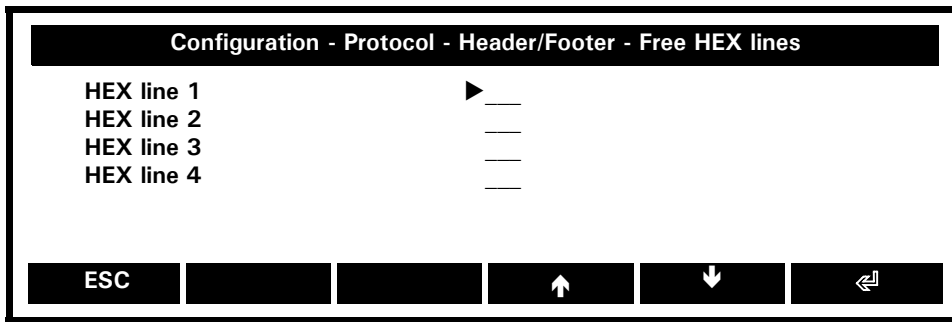

HEX Line 1: ____

Defines hexadecimal characters of line 1, e.g.: 27, 01, 02, 0D, 0A (=ESC, 01, 02, CR, LF)

HEX Line 2: ____

Defines hexadecimal characters of line 2, e.g.: 27, 00, 0D, 0A (=ESC, 00, CR, LF)

HEX Line 3: ____

Defines hexadecimal characters of line 3

HEX Line 4: ____

Defines hexadecimal characters of line 4

10.4.4.3 Configuration - Protocol - Header/Footer - Position

At last there are a lot of ready-to-pick items which can be printed out in the protocol. Each position, if called up, offers its possibilities in a list box. Observe that the same item can be assigned to various positions at the same time, for example „Underline“ to the positions 2, 4 and 7.

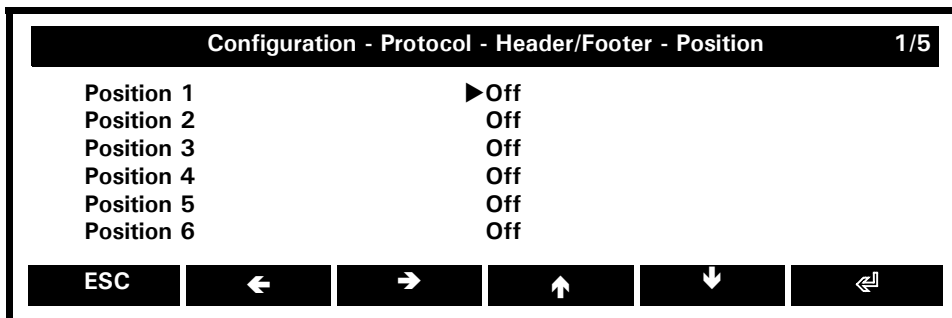

Some items can only be assigned either to the header or to the footer, others are assignable to both zones. The following table gives an overview of all items and their assign options:

How it Looks in the Printout (example)	Where Assignable	Name and Brief Information
***** Weighing *****	Header	Application Names the running application, see chapter 12 "Applications and Functions"
Balance EP 8200C-DR	Header	Device type Names the device type
Device ID AA1	Header	Device ID Names the device identification, e.g. „AA1“, see chapter 10.6 "Configuration - Device settings"
Device Number 4600031	Header	Device number Names the number of the device
Software A00-0000 P03	Header	Device software Names the software the device operates with

18.01.09 19:15:02	Header & Footer	Date/Time <i>Prints out the actual Date and Time, see chapter 10.7 "Configuration - Date/Time"</i>
User Administrator	Header & Footer	User <i>Names the user, learn more in chapter 11.2 "The Administrator Menu"</i>
Signature _____	Footer	Signature <i>Prints out a space holder for a handwritten signature</i>
„Free text“	Header & Footer	Text line 1 ... 5 <i>Prints out the defined text of the corresponding chosen free text line (1 ... 5), see chapter 10.4.4.1 "Configuration - Protocol - Header - Free text lines"</i>
„Free HEX Line“	Header & Footer	HEX Line 1 ... 4 <i>Prints out the content of the corresponding chosen free Hex line (1 ... 4), see chapter 10.4.4.2 "Configuration - Protocol - Header/Footer - Free HEX lines"</i>
-----	Header & Footer	Underline <i>Prints out an underline</i>
„Empty line“	Header & Footer	Linefeed <i>Prints an empty line</i>
„Form feed“	Footer	Formfeed <i>Executes a form feed command</i>

10.5 Configuration - Interface

Configuration - Interface

Baudrate	▶ 9600
Parity	7 Even 1
Handshake	None
PC direct mode	Off

ESC
↑
↓
↵

Baudrate: 300, 600, 1200, 2400, 4800, **9600**, 19200, 38400, 57600

Selects a baud rate for the RS232/V24 interface in order to match with the interface of a connected peripheral device, learn more in chapter 13 "Data Transfer"

Parity: **7 Even 1**, 7 Odd 1, 7 None 2, 8 None 1

Selects a parity for the RS232/V24 interface in order to match with the interface of a connected peripheral device, learn more in chapter 13 "Data Transfer"

Handshake: **None**, XOn / XOff, Hardware

Selects the handshake for the RS232/V24 interface in order to match with the interface of a connected peripheral device, learn more in chapter 13 "Data Transfer"

PC direct mode: On, **Off**

Enables/disables the PC direct mode, learn more in chapter 13 "Data Transfer"

10.6 Configuration - Device settings

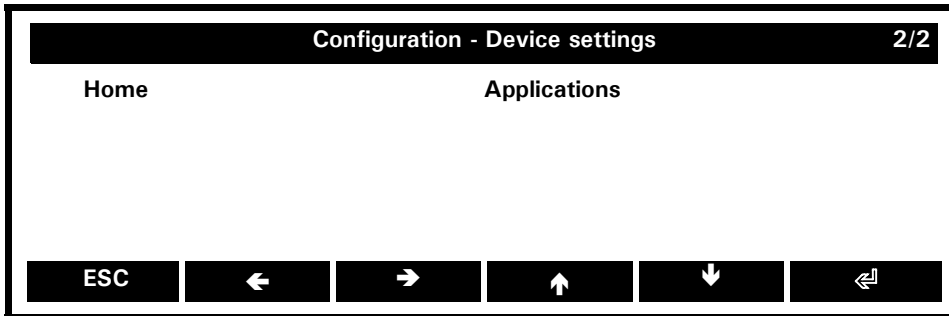
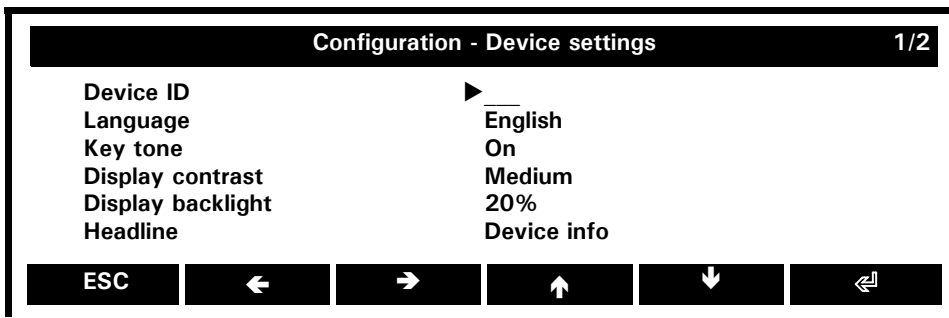

Device ID:

Allows to put in an alpha-numerical identification (max. 20 characters) which is also displayed during the start-up sequence, when the balance is switched on

Language: English, Deutsch, Française

Selects a language

Key tone: On, Off

Activates the key tone

Display contrast: low, medium, high

Adjusts the level of the display contrast

Display backlight: 20%, 40%, 60%, 80%, 100%

Adjusts the level of the display backlight

Headline: Device info, Date/Time

- The headline displays the running application with weighing range and readability

- The headline displays the running application and the system clock with date & time

Home: Applications, User

- The menu „Applications“ is selected after acceding to the home screen

- The menu „User“ is selected after acceding to the home screen

10.7 Configuration - Date/Time

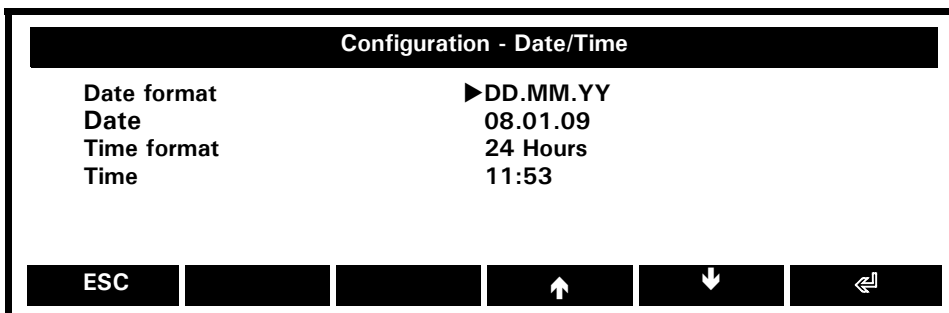

Date format: DD.MM.YY, DD.MM.YYYY, MM.DD.YY, MM.DD.YYYY

Selects the date format

Date: 26.12.08

Sets the clock date

Time format: 12 Hours, 24 Hours

Selects the time format

Time: 08.19.57

Sets the clock time



NOTE

If a power failure occurs, the timer continues running. If this does not happen, this indicates that the instrument's backup battery has expired and has to be replaced by the Customer Service.

10.8 Configuration - Minimal sample weight

The minimal sample weight function is discussed in chapter 12.2.3 "Power Function: Minimal sample weight"

Configuration - Min. sample weight	
Tare range 1	▶0.000 g
Min. sample weight 1	0.000 g
Tare range 2	0.000 g
Min. sample weight 2	0.000 g
Tare range 3	0.000 g
Min. sample weight 3	0.000 g

ESC ↑ ↓ ↩

Tare range 1: 0.000 g

Sets the tare range 1

Min. sample weight 1: 0.000 g

Sets the minimal sample weight 1 for tare range 1

Tare range 2: 0.000 g

Sets the tare range 2

Min. sample weight 2: 0.000 g

Sets the minimal sample weight 2 for tare range 2

Tare range 3: 0.000 g

Sets the tare range 3

Min. sample weight 3: 0.000 g

Sets the minimal sample weight 3 for tare range 3

10.9 Configuration - Draft shield

This chapter is about customizing the automatic draft shield upon your requirements:

Configuration - Draft shield	
Settings	▶Define
Left sensor	Open right
Right sensor	Open left

ESC ↑ ↓ ↩

Settings: Define

Defines the general settings of the draft shield.

■ 10 The Configuration

Left sensor: Open left, **Open right**, Tare, Print, Store sample, Off

Assigns that as soon as the sensor perceives any movement,

- the door opens on the left side
- the door opens on the right side
- the tare command is executed
- the print command is executed
- the sample is stored
- nothing happens

Right sensor: Open left, Open right, Tare, Print, Store sample, Off

The setting options of the right and the left sensor are the same, thus see previous point above.

10.9.1 Configuration - Draft shield - Settings

Configuration - Draft shield - Settings					
Door			▶ Define		
Sensor			Define		
ESC			↑	↓	↶

Draft shield: Define

Defines the speed and the opening width of the draft shield door.

Sensor: Define

Sets an and defines the sensitivity of the draft shield sensors.

10.9.1.1 Configuration - Draft shield - Settings - Door

Configuration - Draft shield - Settings - Door					
Door speed			▶ Normal		
Opening width left			Full		
Opening width right			Full		
ESC			↑	↓	↶

Door speed: Fast, **Normal**, Slow

Defines the speed of the draft shield door.

Opening width left: 1/3, 2/3, **Full**

Defines the left side opening width of the draft shield door.

Opening width right: 1/3, 2/3, **Full**

Defines the right side opening width of the draft shield door.

10.9.1.2 Configuration - Draft shield - Settings - Sensor

Configuration - Draft shield - Settings - Sensor					
Acoustic signal			▶ On		
Sensitivity			Medium		
ESC			↑	↓	↶

Acoustic signal: Off, On

Sets on/off the acoustic signal to indicate the sensors' movement perception.

Sensitivity: Low, Medium, High

Defines the sensitivity of the draft shield sensors.

10.10 Configuration - Properties

Select this menu item to display all settings of the configuration in an info window. To printout the content of this info window, press «**PRINT**», see also chapter 8.6 "The Info window".

11 The Administrator and the User Profiles

It is possible to save one administrator profile and 7 different user profiles. A profile consists of all the configuration and application settings.

11.1 Resetting to the Factory Configuration

As administrator you can reset the balance to the basic configuration programmed in the factory at any time. Thereby all configuration and application settings will be set to the default settings.

- Hold «MENU»
- Keep pressing {→} until „Settings“ in the headline is selected
- Press {▲} beneath the Administrator icon
- Keep pressing {▼} until the menu item „Set factory settings“ is selected and
- Press {↵} to confirm your selection
- Affirm the question „Set factory settings?“ by pressing {Yes}

11.2 The Administrator Menu

- Hold «MENU»
- Keep pressing {→} until „Settings“ in the headline is selected
- Press {▲} beneath the Administrator icon

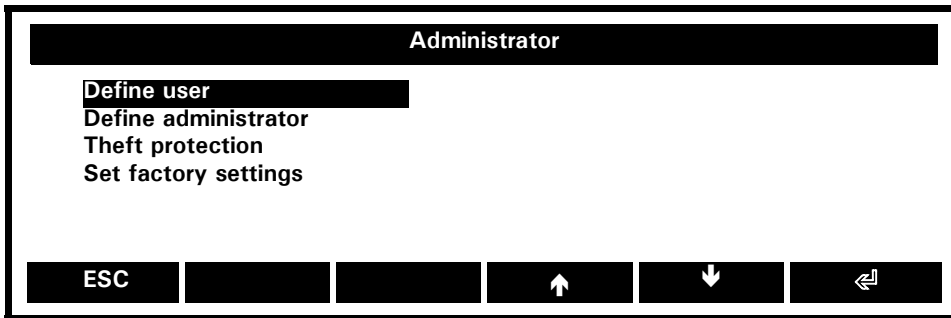

Define user:

Defines up to 7 user profiles of the balance, see chapter 11.2.1 "Administrator - Define user" below

Define Administrator:

Defines the administrator profile

Theft protection:

Sets up the theft protection with password

Set factory settings:

Sets all configuration and application settings to the default settings, see chapter 11.1 "Resetting to the Factory Configuration" above



NOTE

Setting the factory settings as administrator clears and disables also all user profiles!

11.2.1 Administrator - Define user

This menu allows the administrator to manage the entire user list.

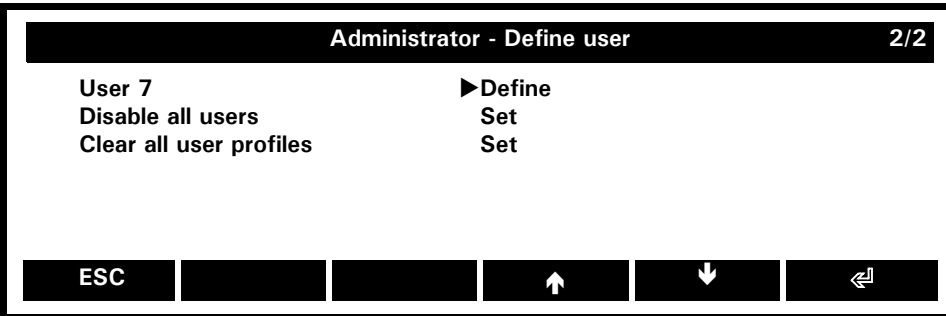
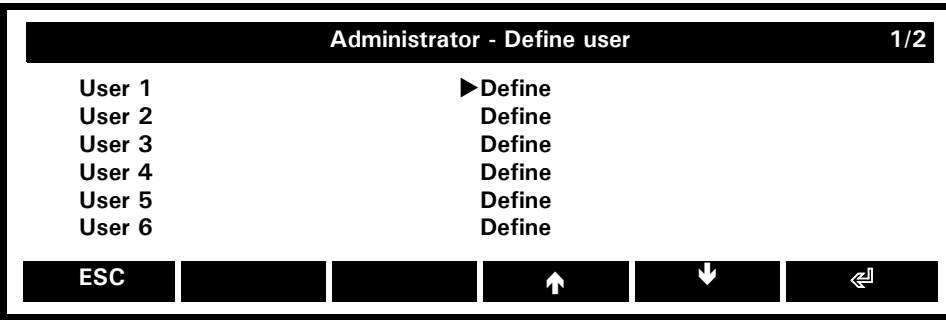

User 1/2/3/4/5/6/7: Define

Defines the user 1/2/3/4/5/6/7

Disable all users: Set

Disables all users

Clear all user profiles: Set

Clears all user profiles

11.2.1.1 Administrator - Define user - User 1/2/3/4/5/6/7

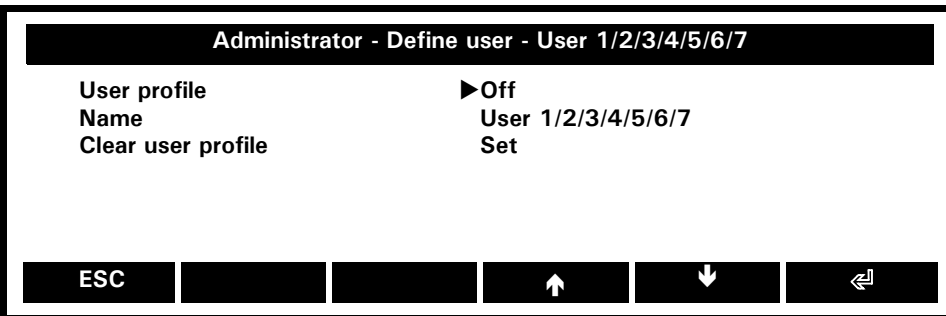

User 1/2/3/4/5/6/7: On, Off

Enables/disables the user 1/2/3/4/5/6/7

Name: User 1/2/3/4/5/6/7

Names the user 1/2/3/4/5/6/7

Clear user profile: Set

Clears the selected user profile 1/2/3/4/5/6/7

■ 11 The Administrator and the User Profiles

11.2.2 Administrator - Define administrator

This menu is about defining the administrator.

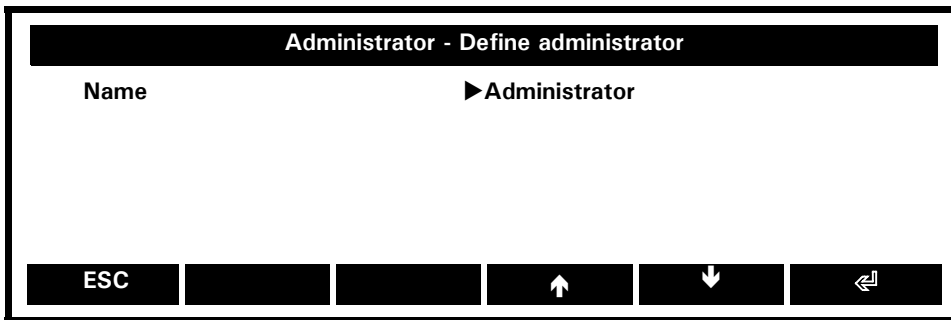

Name: Administrator

Names the administrator



NOTE

The name given to the administrator will just appear in protocols. In menus it continues appearing as „Administrator“.

11.2.3 Administrator - Theft protection

The administrator is allowed to protect the balance against theft by using a freely selectable, up to six-digit numerical code. To accede this menu, it is necessary to put in the anti-theft code first.



NOTE

The anti-theft encoding is deactivated in the factory settings.

The **preprogrammed code** set at the factory is: **8 9 3 7**

This code is the same in all balances. Therefore, for security reasons, enter your own code.

Keep your **own code** in a safe place.



Theft protection: Off, On

Disables/enables the theft protection

Password: ****

Enter a new anti-theft code

In the administrator profile the balance can be protected against theft by using a freely selectable, up to six-digit numerical code:

- If the anti-theft code is deactivated, the instrument can be re-started and operated after a power outage without having to enter a code.
- If the anti-theft code is activated, the instrument requires the code to be input after each power outage.
- If the code is entered incorrectly, the instrument is locked.
- If the instrument is locked, it must first be disconnected from the power supply, then reconnected and unlocked by entering the correct code.
- After seven consecutive incorrect entries, the display reads „NO ACCESS, CALL SERVICE“. In this case

only a service engineer can unlock the instrument again.



NOTE

Neither the theft protection status nor the anti-theft code changes by resetting the device to the factory settings.

12 Applications and Functions

Applications are features suited to specific weighing problems.

The context menu of an application has always the following structure: at first there are listed the specific functions, followed by the available power functions (see chapter 12.2 "Power Functions") and utilities (see chapter 12.3 "Utilities").

Finally there is an item „Properties“ at the bottom to display all settings of the current application in an info window.

12.1 Enabling and Disabling Applications

By default all applications are enabled and listed in the home screen, see also chapter 9.1 "The Applications Menu":

- Hold «MENU» to switch the home screen.

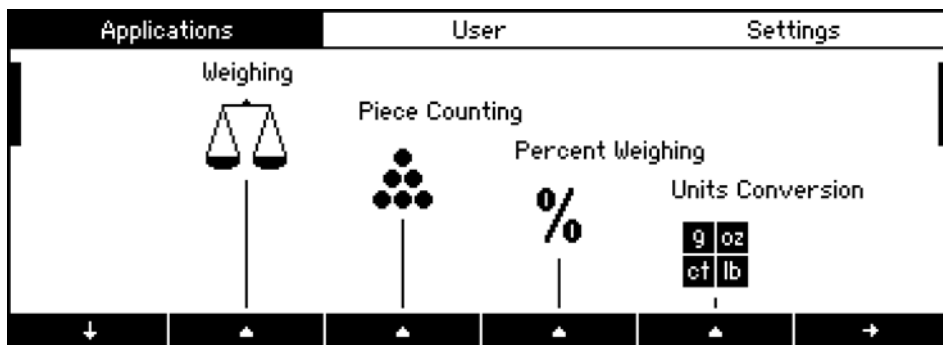

This can be changed, i. e. single applications can be disabled:

- Keep pressing {→} until the settings menu is selected.

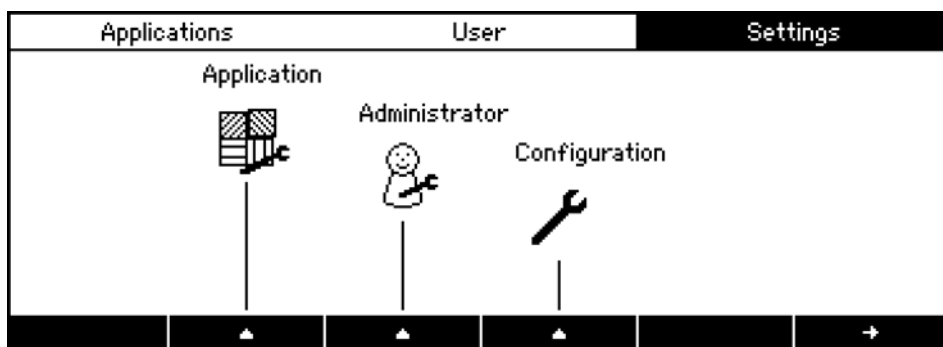

- Switch the icon „Application“ by pressing the correspondent {▲}.

The menu displays all available applications. In front of an enabled application, an asterisk '*' is displayed:

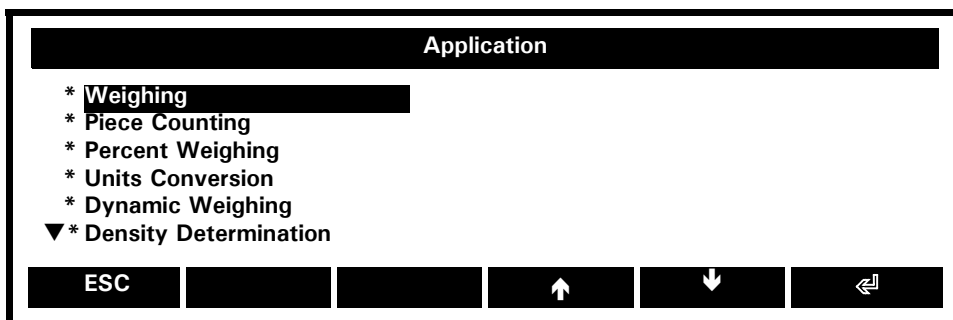

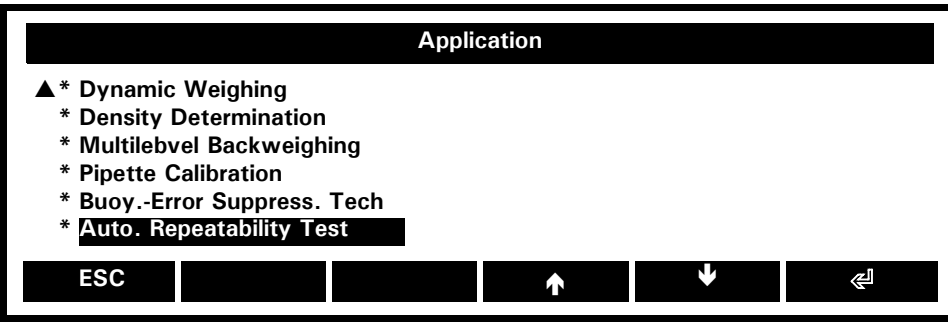

To change the settings of an application, highlight it with {↑} or {↓} and press {↵}, here for instance Piece Counting:

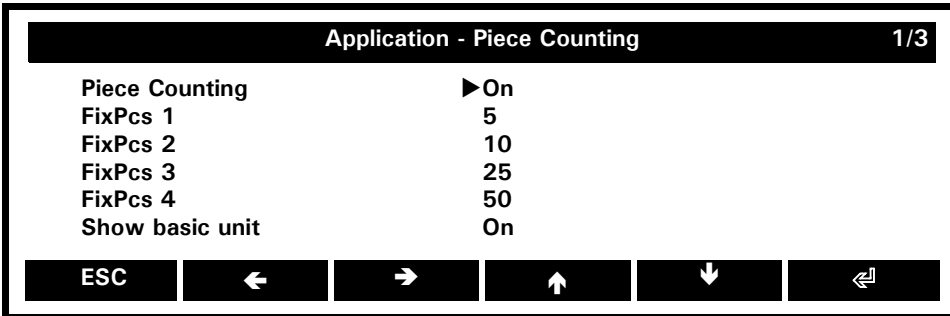

Enable/disable the highlighted application by setting it on/off.

A disabled application, listed without asterisk in the application menu (here e.g. „Piece Counting“), in the settings menu section of the home screen ...

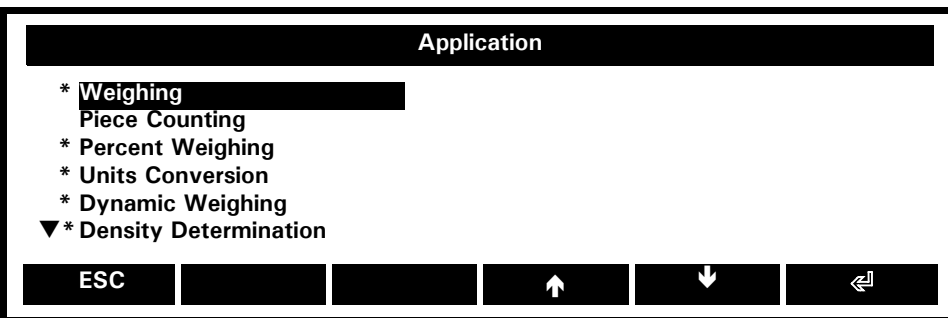

... results no longer switchable in the applications section of the home screen:

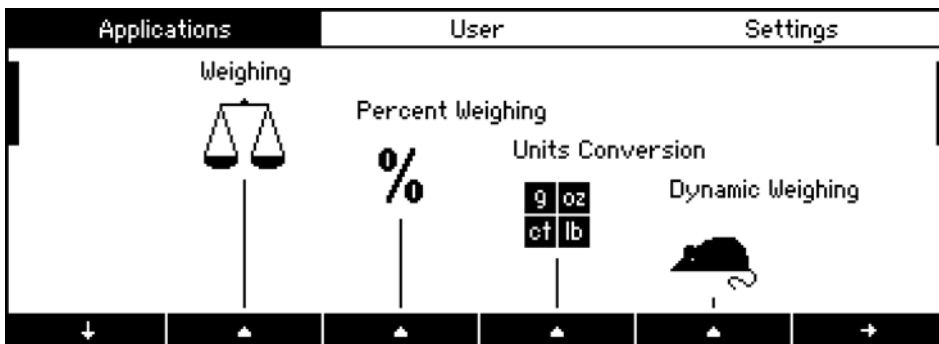

NOTE
 Customizing the settings of a **disabled**, i.e. non switchable application can only be done in the menu Application of the settings menu section of the home screen, as just shown above.

12.2 Power Functions

A power function is many functions in one, a real function package. It is a *common function*, available in the most applications. With a power function it is possible to extend an application with common skills.

Let's have a closer look to the single power functions:

- Hold «MENU» to switch the home screen.
- Switch for instance the icon „Weighing“ by pressing the correspondent {▲}.
- Press «MENU» to switch the context menu. (Menu items, marked with „>“ are power functions)

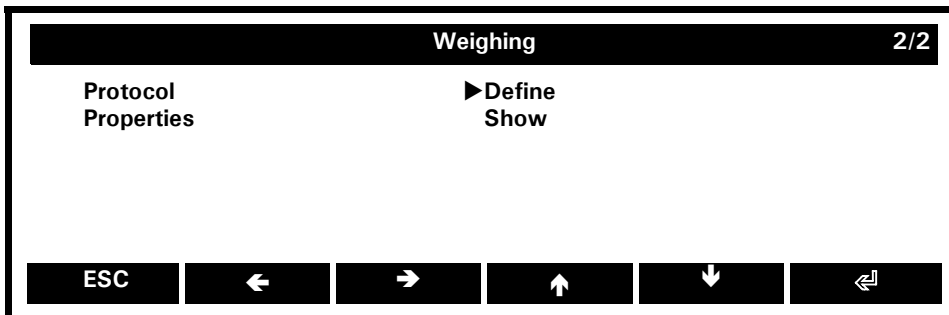
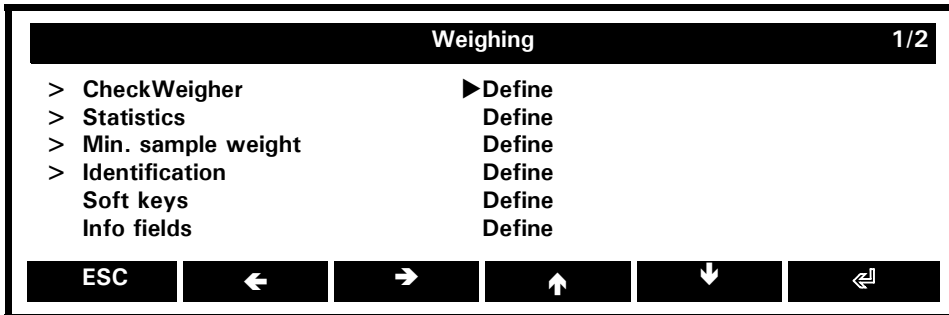

12.2.1 Power Function: CheckWeigher

The CheckWeigher is to check each measurement for its agreement with a defined reference value, plus/minus allowable deviations. In the display the „check weigher info“ is active and indicates if the measured value lies within the specified tolerances TO and TU.

- Hold «MENU» to switch the home screen.
- Switch for instance the icon „Weighing“ by pressing the correspondent {▲}.
- Press «MENU» to switch the context menu.
- Press {↵} to define the power function CheckWeigher.

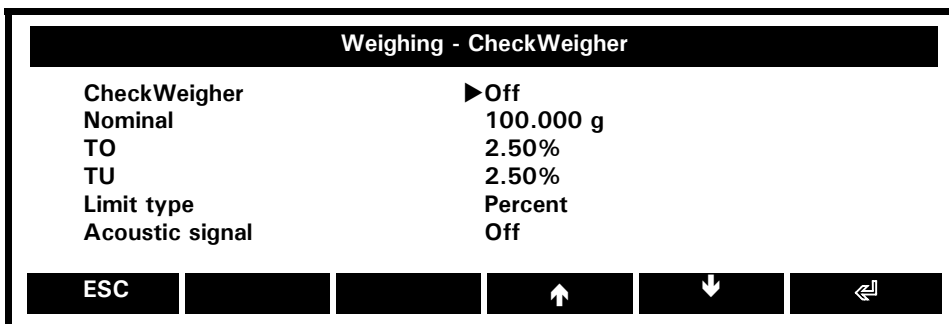

CheckWeigher: On, Off

CheckWeigher enabled/disabled

Nominal: 100.000 g

Nominal weight

TO: 2.5% (or 0.000 g)

Over limit according to the application as weight in the basic unit, in percent or in pieces

TU: 2.5% (or 0.000 g)

Under limit according to the application as weight in the basic unit, in percent or in pieces

Limit type: Percent, Weight, Pieces

Limits TO/TU according to the application as weight in the basic unit, in percent or in pieces

Acoustic signal: On, Off

Acoustic signal for acoustic indication

By default assigned and available (off) specific soft key functions:

CheckW. Limits: Fixed

Fast access to setup new limits. This soft key function, if fixed, is by default permanently assigned to the extreme right position on the function bar and changes to the penultimate position, only if the statistics power function is enabled, to make room for „STORE i“.

CheckW. Val/Val-Nom: Off

Toggle from the absolut display (of the net value) to display the difference (from the net value to the nominal value).

By default assigned and available (off) specific info fields:

CheckW. Nominal: Page3 / Top right

Nominal weight

CheckW. TO: Page3 / Top left

Over limit

CheckW. TU: Page3 / Bottom left

Under limit

Available specific protocol items

Name and Brief Information	How it Looks in the Printout (Example)
... : CheckW. Nom. Nominal weight (printout with enabled power function CheckWeigher only)	CheckW. Nom. = 100.00 g
... : CheckW. TO Over limit (printout with enabled power function CheckWeigher only)	CheckW. TO = 105.00 g
... : CheckW. TU Under limit (printout with enabled power function CheckWeigher only)	CheckW. TU = 95.00 g

12.2.2 Power function: Statistics

The statistics function logs all measuring data in order to provide you anytime with a wide range of statistical information for a series of measurements. All data can be displayed and printed out upon your requirements. To take a closer look in practice, e.g. in chapter 7 "Discover the Capabilities of the New Series 360 EP"

- Hold «**MENU**» to switch the home screen.
- Switch for instance the icon „Weighing“ by pressing the correspondent {▲}.
- Press «**MENU**» to switch the context menu.
- Keep pressing {↓} until the menu item „Statistics“ is selected.
- Press {↵} to define the power function Statistics.

**NOTE**

The statistics power-function has its own, particular protocol section. In case its auto-print item is enabled (see above), it overrides the common power function „Protocol“.

**NOTE**

The statistics function logs all measuring data and displays them as a statistics log in an info window as soon as **{ShowStat}** is pressed. A subsequent pressing of the «**PRINT**» key transfers the entire log via interface to the peripherals, e.g. a computer or a printer.

[Title „Statistics“: On, Off]

(only available with enabled Auto-print)

Prints the title „Statistics“ as Headline of every statistics log

Sample: Define

Defines the sample settings, see chapter 12.2.2.2 "Particular statistics protocol: Sample settings" below.

[Intermediate result: On, Off]

(only available for enabled Auto-print)

If enabled, in addition to each sample within a series of measurements, further information is transferred to the peripherals. By default the additional information is as follows:

- Number of the sample
- Total weight of all samples
- Mean of all samples
- Standard deviation
- Standard deviation in %

To change coverage and sequence of this additional part, see next point and chapter 12.2.2.3 "Particular statistics protocol: Result settings" below.

**NOTE**

The intermediate result is effective just for transfer to the peripherals. In an info window (available as soon as **{ShowStat}** is pressed) the single samples, if enabled, are always listed without the additional information, just the final report is referred as mentioned above under „Intermediate result“.

Result: Define

Defines coverage and sequence of the protocol positions. See chapter 12.2.2.3 "Particular statistics protocol: Result settings" below.

12.2.2.2 Particular statistics protocol: Sample settings

Weighing - Statistics - Protocol - Sample		1/2
Sample	► On	
Measured value	Value	
[ID 1]	Off	
[ID 2]	Off	
[ID 3]	Off	
[ID 4]	Off	

ESC ← → ↑ ↓ ↶

■ 12 Applications and Functions

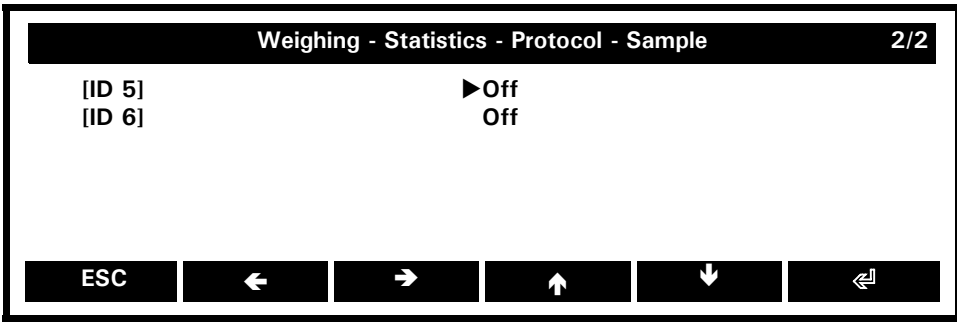

Sample: On, Off

If enabled, every single sample is listed in the statistics log.

Measured value: Value, Time + Value, Date + Value, Date/Time + Value
 Adds by wish date, time or both, to the printout of the measured value.

[ID 1/2/3/4/5/6: Off, Before value, After value]

(only available for enabled Auto-print)

- Disables the ID 1/2/3/4/5/6.
- Prints out the ID before (above) the measured value.
- Prints out the ID after (below) the measured value.

12.2.2.3 Particular statistics protocol: Result settings

Similar to the common settings of the protocol midsection described in chapter 12.3.3 "Utility: Protocol", you can customise the aspect of the statistics protocol, which may consist of up to 15 positions. Each position, if called up, offers its possibilities in a list box.

Observe that the same item can be assigned to various positions at the same time, for example „Linefeed“ to the positions 2, 9 and 11.

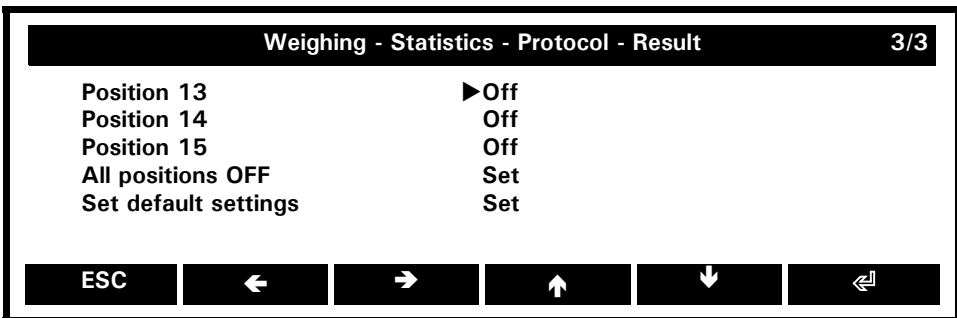
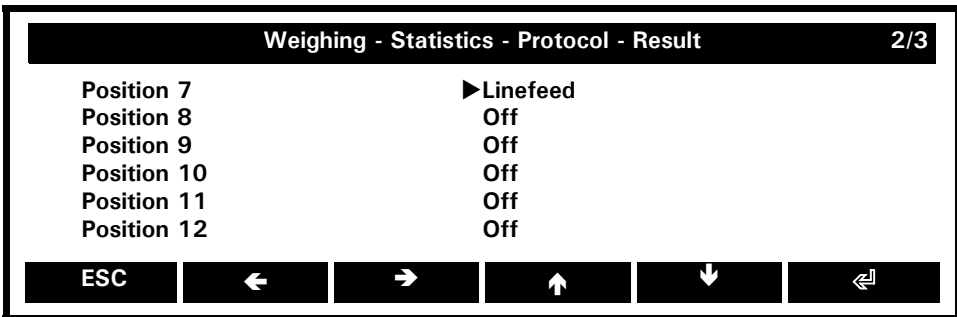
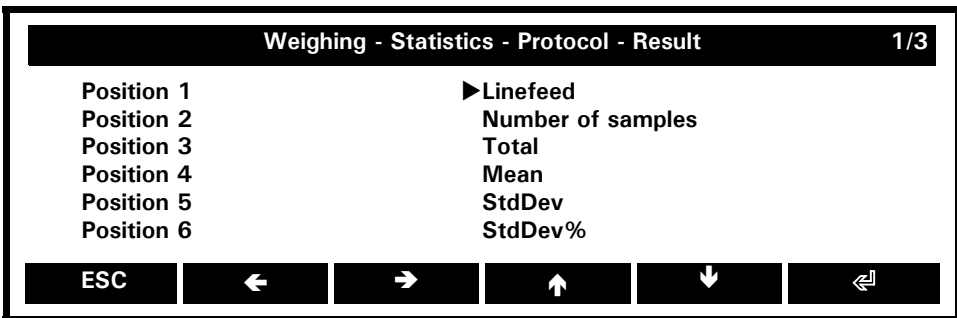

Position 1/2/ ... /14/15:

Assigns single items to the up to 15 positions of the statistics protocol. See table below. Some items are set by default

All positions OFF: Set

Disables, by pressing {←}, all statistics protocol positions.

Set default settings: Set

Sets, by pressing {←}, all statistics protocol positions by default, i.e. as shown in the three menu pages above.

12.2.2.4 Available particular statistics protocol items:

Name and Brief Information	How it Looks in the Printout (Example)
Off <i>Disables the selected position</i>	„No printout“
Number of samples <i>Number of samples of the actual series of measurements.</i>	Samples 10
Total <i>Total weight of all samples of the actual series of measurements.</i>	Total 1018.454 g
Mean <i>Mean of all samples of the actual series of measurements.</i>	Mean 101.845 g
StdDev <i>Standard deviation of the actual series of measurements.</i>	StdDev 2.4520 g
StdDev% <i>Standard deviation in percent of the actual series of measurements.</i>	StdDev% 2.41 %
Min/Max/Diff <i>The smallest and the biggest sample of the actual series of measurements and the difference between them.</i>	Min. 100.021 g Max. 107.071 g Diff. 7.050 g
Limits TU/TO <i>With enabled CheckWeigher only: CheckWeigher limits</i>	CheckW. Nom. = 100.000 g CheckW. TO = 2.50 % CheckW. TU = 2.50 %
TU/TO counter <i>With enabled CheckWeigher only: Number of samples outrunning the CheckWeigher limits, divided in overrunnings (> TO) and underrunnings (< TU).</i>	> TO 2 < TU 0
Start Date/Time <i>Starting point of the series of measurements.</i>	Start Date/Time 27.08.09/06:53:19
End Date/Time <i>Ending point of the series of measurements.</i>	End Date/Time 27.08.09/06:57:12

■ 12 Applications and Functions

ID - ID 1 <i>With enabled ID 1 only: ID 1</i>	ID 1 : „your entry“
ID - ID 2 <i>With enabled ID 2 only: ID 2</i>	ID 2 : „your entry“
ID - ID 3 <i>With enabled ID 3 only: ID 3</i>	ID 3 : „your entry“
ID - ID 4 <i>With enabled ID 4 only: ID 4</i>	ID 4 : „your entry“
ID - ID 5 <i>With enabled ID 5 only: ID 5</i>	ID 5 : „your entry“
ID - ID 6 <i>With enabled ID 6 only: ID 6</i>	ID 6 : „your entry“
Linefeed <i>Prints out an empty line</i>	„Empty line“
Underline <i>Prints out an underline</i>	-----

12.2.2.5 Common settings

By default assigned and available (off) specific soft key functions:

STORE i: This soft key function is always assigned and permanently fixed on the right end of the function bar whenever the power function Statistics is enabled. The soft key can show:

- STORE i to take the value i
- START i to start/stop of automatic recording (Timebase, Loadchange) with value i
- AUTO i when automatic recording is running
- WAIT i when the value to store has not stabilized yet

Statist. Clr Sample: Off

Clear last stored sample

Statist. Clr Stat.: no. 10

Clear/reset the statistics

Statist. Show Stat.: no. 11

Show all the statistics information in an info window

Statist. Max. n: Off

Show/change number of values to be stored automatically

By default assigned and available (off) specific info fields:

Stat. Max. n: Off

Number of maximum values to be stored

Stat. n: Off

Number of the currently stored value.

Stat. Mean: Page5 / Top right

Mean value

Stat. StdDev: Page5 / Bottom right

Standard deviation

Stat. StdDev%: Off

Relative standard deviation

Stat. Total: Page5 / Bottom left

Add up of all stored values

Stat. Max.: Off*Maximum value***Stat. Min.: Off***Minimum value***Stat. Diff.: Off***Difference from Maximum value to Minimum value***Stat. >TO.: Off***Number of values over limit***Stat. <TU: Off***Number of values under limit***Stat. Value n: Page5 / Top left***Last measured value***Stat. Value n-1: Off***Last-1 measured value***Stat. Value n-2: Off***Last-2 measured value***Stat. Value n-3: Off***Last-3 measured value***Available specific protocol items**

None; only particular protocol items available, see chapter 12.2.2.4 "Available particular statistics protocol items:"

12.2.3 Power Function: Minimal sample weight

The minimal weight function is a solution which enables you to fulfill QM guidelines, such as GLP, GMP or USP, see also chapter 10.8 "Configuration - Minimal sample weight".

12.2.3.1 Minimal Sample Weight and Quality Management

Only very small quantities are used in many applications and, thus, only a small part of the balance's weighing capacity is used. However, the lower the weight, the greater the relative measuring uncertainty. What is the minimum weight necessary to enable the quality management tolerance limits to be complied? The minimum weight which is required is determined on the basis of the QM criteria and of the statistical data from repeated weighing procedures.

If the weight is below the minimum weight, a warning appears on the balance display warning you of this; these values are also marked in the printout.

- The **requisite minimum weights** should be elicited on the basis of the QM specifications by means of the statistical analysis of certain series of measurements.
(The balance's own „Statistics“ function could be used for this purpose, for example. It is used to perform and subsequently log the requisite series of measurements.)
- Once the minimum weight(s) has/have been determined, it/they can be input into the balance. Up to three tare ranges can be defined with the corresponding minimum weights.
The balance's weighing modes, as well as measuring time and stability, are also fixed in such a way as to guarantee compliance with tolerances in future measurements.
Tare ranges, minimum weights and weighing modes cannot be changed by the user.
- The values which are input can be logged by means of an configuration status print and could, along with the report on the statistical measurement series, be used as a **QM certificate**.
If work is performed on the basis of the minimum weight application, this serves to ensure that the weighing results conform to the certificate specifications and, thus, to your QM guidelines.

12.2.3.2 Determining the Parameters for the Minimum Sample Weight Periodically

The minimum weight is dependent on the ambient conditions. Therefore, it must be determined on-site and must be reviewed periodically.

The following parameters influence the minimum weight:

■ 12 Applications and Functions

- **Repeatability:**

The repeatability is determined by the standard deviation of the balance on-site. It is determined by the ambient conditions, the nature of the goods being weighed and the balance settings.

- **Tare weight**

- **Relative uncertainty (U):**

The tolerable uncertainty is determined by the user or defined by standards.

- **Extension factor (k)** (generally 2 or 3):

The extension factor determines the likelihood of occurrence. The factor is defined by the user or is defaulted.

The minimum weight is calculated as follows:

$$\text{Min. Weight}[\text{MIN}] = \frac{\text{Extension factor}[k] \cdot \text{Standard deviation}[\text{StdD}]}{\text{Relative uncertainty}[U]}$$

Example of figures for the MSW in accordance with the USP:

If work is conducted in accordance with the USP (United States Pharmacopoeia), the following parameters are given:

- **Repeatability:**

Standard deviation if the same weight is placed on ten times.

- **Extension factor:**

k = 3

- **Rel. uncertainty:**

U = 0.1%

The repeatability of an EP165SM in the tare range between 0 and 35 g was determined as a standard deviation on site by placing a weight on ten times and measures 0.025 mg.

The minimum weight is thus calculated as follows:

$$\text{Min. Weight}[\text{MIN}] = \frac{3 \cdot 0.025 \text{ mg}}{0.1\%} \cdot 100\% = 75 \text{ mg}$$

In compliance with USP24-NF19, the weight on the EP165SM may not be less than a minimum of 75 mg.

Recommended procedure:

- Conduct the tests on-site and as close to the real situation as possible.
- Try to provide the best possible ambient conditions.
Ensure that these conditions do not deteriorate significantly afterwards in normal operation.
- First of all, configure the weighing parameters, 10.2 "Configuration - Weighing parameters".
- Define the due-date for the next check, in accordance with your QM specifications.
- Define the extension factor and relative uncertainty in accordance with your QM specifications and describe this test parameters for information purposes.
- Determine the minimum weight(s) for your balance as follows:

Determining repeatabilities / Defining tare ranges:

- First of all, test the behavior of the balance in different tare ranges:
Divide the balance's weighing range into 10g intervals, for example, and measure the repeatability for each interval.
Draw a graph of the entire weighing range by plotting all the results, joining them together and working

out the mean:

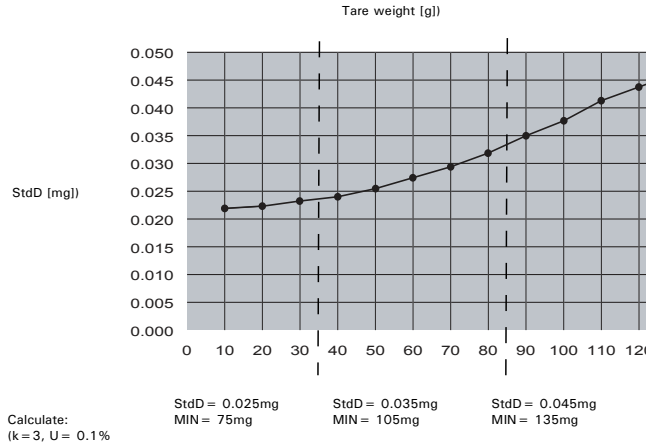

- On the basis of this graph it is relatively easy to define the max. 3 ranges with the corresponding repeatabilities. (If you know which tare weights are typically used, you can optimize the tare ranges in terms of these typical weights.)

Measuring the repeatability (StdE) with the aid of „Statistics“: Apply the relevant tare weight permanently to the balance and tare it. Conduct the measurement series with a net weight of approx. 1g:

- 1: + 1.00287 g *Example of how the statistics function is used.*
- 2: + 1.00291 g
-
- 9: + 1.00288 g
- 10: + 1.00290 g
- Values :
- Mean : + 1.00289 g
- StdE : + **0.000022** g
- StdE % : 0.00 %
- Max : + 1.00293 g
- Min : + 1.00287 g

- Calculating the minimum weight(s):

Now calculate the minimum weights using the equation shown above, on the basis of the repeatabilities belonging to the tare ranges.

- To configure the balance with the determined values, see chapter 10.8 "Configuration - Minimal sample weight".

12.2.3.3 Setup the Power Function Minimal sample weight

The Minimal Weight function is a solution which enables you to fulfill QM guidelines, such as GLP, GMP or USP.

!	NOTE
Additional balance specific settings, e.g. for the different tare ranges of the Minimal Weight can be done in the Configuration Menu, see chapter 10.8 "Configuration - Minimal sample weight"	

- Hold «**MENU**» to switch the home screen.
- Switch for instance the icon „Weighing“ by pressing the correspondent {▲}.
- Press «**MENU**» to switch the context menu.
- Keep pressing {↓} until the menu item „Min. sample weight“ is selected.
- Press {←} to define the power function Min. sample weight.

■ 12 Applications and Functions

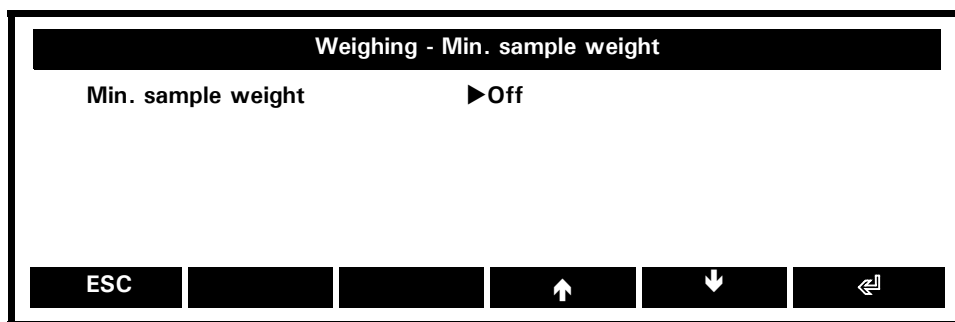

Minimal sample weight: On, Off

Minimal sample weight enabled/disabled

By default assigned and available (off) specific soft key functions:

None

By default assigned and available (off) specific info fields:

Min. sample weight: Off

Displays minimal sample weight according to current tare range

Available specific protocol items:

Name and Brief Information	How it Looks in the Printout (Example)
... : Min.samp.weight <i>Minimal sample weight (printout with enabled power function Minimal sample weight only)</i>	MinWgt : 1.00 g

12.2.4 Power function: Identification

Weighing in goods in packages, e.g. for clients, every package needs to be labeled. A label can be printed out like a protocol and consist of unvarying and varying information. Let's do the following

Example:

Your company, CHEMIX, has to pack chemicals as follows:

Order: 20090001, Client: CityLab:

3 times 200 g of Na HCO₃

2 times 100 g of Fe Cl₃

Order: 20090002, Client: FoodLab:

5 times 100g of C₆ H₁₀ O₁₀

Define the unvarying parts of the labels, the header and the footer in the configuration menu (see operating details in chapter 10.4 "Configuration - Protocol"):

Header: On

Free text 1: CHEMIX

Position 1: Free text 1

Position 2: Linefeed

Footer: On

Position 1: Linefeed

Position 2: Date/Time

Position 3: Formfeed

Now the varying part. Switch the application Weighing, enter its context menu and define as follows:

Identification:

ID 1: On

Name: Order

ID 2: On

Name: Client

ID 3: On

Name: Article

ID 4: On

Name: Art.-no.

Protocol (power function specific):

Position 1: ID - Article

Position 2: Linefeed

Position 3: Current value

Position 4: Linefeed

Position 5: ID - Art.-no.

Position 6: ID - Order

Position 7: ID - Client

Soft keys:

ID1: no. 1

ID2: no. 2

ID3: no. 3

ID4: no. 4

Return to the application Weighing and observe the function bar:



The following data entries can also be done e.g. via a bar code reader or a PS2 keyboard (see accessories for details).

- Press **{Order}**
An identification window appears, awaiting your data entry.
- Put in „20090001“
- Press **{Client}**
An identification window appears, awaiting your data entry.
- Put in „CityLab“
- Press **{Article}**
An identification window appears, awaiting your data entry.
- Put in „Na HCO3“
- Press **{Art.-no.}**
An identification window appears, awaiting your data entry.
- Put in „50501“
- Weigh in the first 200g and press «**PRINT**»
You get your first label:

■ 12 Applications and Functions

CHEMIX

Article : Na HCO₃

+ 199.999 g

Art.-no. : 50501

Order : 20090001

Client : CityLab

01.04.09 10:58:32

Weigh in the second 200g and press «**PRINT**»

Weigh in the third 200g and press «**PRINT**»

- Press **{Article}**

An identification window appears, awaiting your data entry.

- Put in „Fe Cl₃“

- Press **{Art.-no.}**

An identification window appears, awaiting your data entry.

- Put in „41208“

Weigh in the first 100g and press «**PRINT**»

You get the label:

CHEMIX

Article : Fe Cl₃

+ 100.002 g

Art.-no. : 41208

Order : 20090001

Client : CityLab

01.04.09 11:03:15

Weigh in the second 100g and press «**PRINT**»

- Press **{Order}**

An identification window appears, awaiting your data entry.

- Put in „20090002“

- Press **{Client}**

An identification window appears, awaiting your data entry.

- Put in „FoodLab“

- Press **{Article}**

An identification window appears, awaiting your data entry.

- Put in „C6 H10 O5“

- Press **{Art.-no.}**

An identification window appears, awaiting your data entry.

- Put in „10081“

Weigh in the first 200g and press «**PRINT**»

You get the label:

CHEMIX

Article : C6 H10 O5

+ 100.001 g

Art.-no. : 10081

Order : 20090002

Client : FoodLab

01.04.09 11:09:40

Keep weighing in until you have your 5 packs ready.

Now let's optimize the packing process and do all the packing again:

Switch the application Weighing, enter its context menu and define as follows:

Identification / Auto scan: On

Scan Pos ID 3: Position 1

Scan Pos ID 4: Position 2

Soft keys:

Set ID: no. 5

Return to the application Weighing and observe the function bar:

Order	Client	Article	Art.-no.	Set ID	
-------	--------	---------	----------	--------	--

Connect a printer and start your packing:

- Press **{Order}**

An identification window appears, awaiting your data entry.

- Put in „20090001“

- Press **{Client}**

An identification window appears, awaiting your data entry.

- Put in „CityLab“

- Press **{Set ID}**

An identification window appears, awaiting your data entry for the enabled auto scan positions.

- Put in „Na HCO3“

- Put in „50501“

- Weigh in the first 200g and press **«PRINT»**

You get your first label:

CHEMIX

Article : Na HCO3

+ 199.999 g

Art.-no. : 50501

Order : 20090001

Client : CityLab

01.04.09 11:22:07

■ 12 Applications and Functions

Weigh in the second 200g and press «**PRINT**»

Weigh in the third 200g and press «**PRINT**»

- Press **{Set ID}**

An identification window appears, awaiting your data entry for the enabled auto scan positions.

- Put in „Fe Cl3“
- Put in „41208“

Weigh in the first 100g and press «**PRINT**»

You get the label:

CHEMIX

Article : Fe Cl3

+ 100.002 g

Art.-no. : 41208

Order : 20090001

Client : CityLab

01.04.09 11:26:19

Weigh in the second 100g and press «**PRINT**»

- Press **{Order}**

An identification window appears, awaiting your data entry.

- Put in „20090002“

- Press **{Client}**

An identification window appears, awaiting your data entry.

- Put in „FoodLab“

- Press **{Set ID}**

An identification window appears, awaiting your data entry for the enabled auto scan positions.

- Put in „C6 H10 O5“
- Put in „10081“

Weigh in the first 200g and press «**PRINT**»

You get the label:

CHEMIX

Article : C6 H10 O5

+ 100.001 g

Art.-no. : 10081

Order : 20090002

Client : FoodLab

01.04.09 11:29:03

Keep weighing in until you have your 5 packs ready.

12.2.4.1 Setup the power function Identification

- Hold «MENU» to switch the home screen.
- Keep pressing {→} until the settings menu is selected.
- Press for instance the icon „Weighing“ by pressing the correspondent {▲}.
- Press «MENU» to switch the context menu.
- Press {→} to access the next page (2/2).
- Press {↵} to define the power function Identification.

Weighing - Identification		1/2
ID 1	► Define	
ID 2	Define	
ID 3	Define	
ID 4	Define	
ID 5	Define	
ID 6	Define	
ESC	←	→
	↑	↓
		↵

Weighing - Identification		2/2
Auto scan	► Define	
Item counter	Volatile	
ESC	←	→
	↑	↓
		↵

ID 1/2/3/4/5/6: Define

Defines the ID 1/2/3/4/5/6, see below, Defining an ID

Auto scan: Define

Defines which enabled ID appears in the identification window, which awaits your data entries.

Item counter: Volatile, Non volatile

Sets the item counter to volatile / non volatile. The item counter increases for 1, every time a print command is executed.

Defining an ID:

Weighing - Identification - ID 1/2/3/4/5/6	
ID 1/2/3/4/5/6	► Off
Name	ID 1/2/3/4/5/6
Datatype	Alphanumeric
ESC	
	↑
	↓
	↵

ID 1/2/3/4/5/6: On, Off

Enables/disables ID 1/2/3/4/5/6

Name: ID 1/2/3/4/5/6

Name of ID 1/2/3/4/5/6, e.g. Order, Client, Article, Art.-no., ID 5, ID 6

Data entry: Alphanumeric, Numeric

Selects between alphanumeric and numeric data entry

■ 12 Applications and Functions

By default assigned and available (off) specific soft key functions:

Set ID: Off

Calls up the identification entry window, awaiting your data.

ID 1/2/3/4/5/6: Off

Calls up the identification entry window, awaiting data of a particular ID

Set Item counter: Off

Sets the item counter to a defined number.

By default assigned and available (off) specific info fields:

[ID - ID1/2/3/4/5/6: Off]

(only available for enabled IDs, see ID 1/2/3/4/5/6: Define, above)

Defined identification, e.g. „Art.-no.“

Item counter: Off

Displays the number of executed print commands

Available specific protocol items:

Name and Brief Information	How it Looks in the Printout (Example)
ID - ID 1 <i>ID 1, e.g. Order</i>	Order : 20090001
ID - ID 2 <i>ID 2, e.g. Client</i>	Client : CityLab
ID - ID 3 <i>ID 3, e.g. Article</i>	Article : Na HCO3
ID - ID 4 <i>ID 4, e.g. Art.-no.</i>	Art.-no. : 50501
ID - ID 5 <i>ID 5</i>	ID 5 : „your entry“
ID - ID 6 <i>ID 6</i>	ID 6 : „your entry“
... : Item counter <i>Item counter</i>	No. : 1

12.3 Utilities

A utility is an assistant. It is a *basic function*, available in the most applications. With a utility it is possible to change aspect and organization of an application.

Let's have a closer look to the single utilities:

- Hold «**MENU**» to switch the home screen.
- Switch for instance the icon „Weighing“ by pressing the correspondent {▲}.
- Press «**MENU**» to switch the context menu. (Menu items, marked with „>“ are utilities)

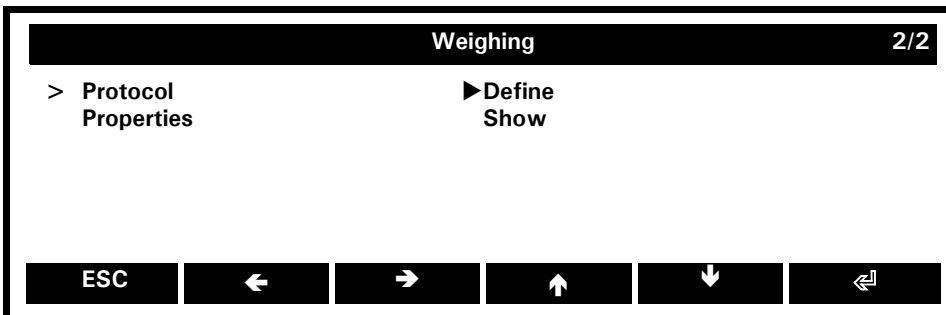
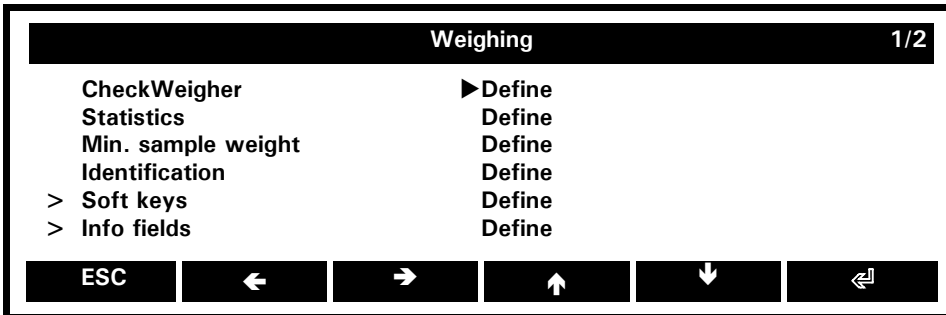

12.3.1 Utility: Soft keys

The utility Soft keys allows you to assign functions to soft keys. Depending on the actual settings of the current application, switching the item Soft keys of the context menu, it is possible to assign to every available soft key function a soft key, which is represented by its position number in a list box. In the application all assigned soft keys will appear in the function bar by order of their position numbers.

Example:

- Hold «**MENU**» to switch the home screen.
- Switch for instance the icon „Weighing“ by pressing the correspondent {▲}.
- Press «**MENU**» to switch the context menu.
- Keep pressing {↓} until the menu item „Statistics“ is selected.
- Press {↶} to define the power function Statistics.
- Press {↶} to enter the statistics list box
- Press {↓} to select the list box item „On“
- Press {↶} to save your selection and
- Press {ESC} to return to the context menu of the running application Weighing.

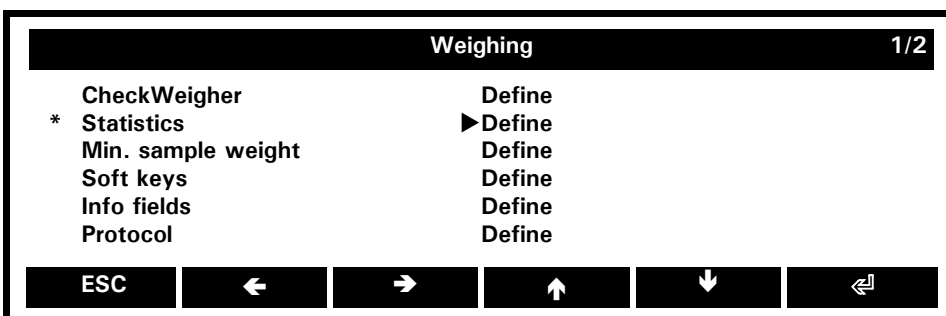

■ 12 Applications and Functions

- Press **{ESC}** to return to the running application Weighing and observe the two assigned soft keys „Clr Stat.“ and „Show Stat.“.

Clr Stat.	Show Stat.				STORE 1
-----------	------------	--	--	--	---------

- Press «MENU» to switch the context menu again.
- Keep pressing **{↓}** until the menu item „Soft keys“ is selected
- Press **{↵}** to define the power function Soft keys.
- Keep pressing **{↓}** until the menu item „Statist. Clr Sample“ is selected
- Press **{↵}**
- Keep pressing **{↓}** until you reach the item „no.12“ in the list box
- save and finish with **{↵}** and
- return to the current application Weighing by pressing **{ESC}, {ESC}**.

Observe that now there are three assigned soft keys: „Clr Stat.“ (no.10), „Show Stat.“ (no.11) and the just assigned „Clr Sample“ (no.12).

Clr Stat.	Show Stat.	Clr Sample			STORE 1
-----------	------------	------------	--	--	---------

12.3.1.1 Available basic soft key functions

The following soft key functions are of general nature and therefore not linked to single power functions or applications. They may be available in various soft key select lists:

Set Pre-Tare: Off

Sets a pre-tare by numerical data entry

[Door left:] Off

(only available if the balance is equipped with an automatic draft shield)

Opens/closes the draft shield door on the left side.

[Door right:] Off

(only available if the balance is equipped with an automatic draft shield)

Opens/closes the draft shield door on the right side.

All Soft keys OFF: Set

Cancel all soft key assignments













Set default settings: Set

Sets all soft key assignments by default

12.3.2 Utility: Info fields

There is a screen section called „Info Page Area“ to display application specific information. Each info page has 4 info fields: Top left, bottom left, top right and bottom right. In an application, holding the «ROTATE» key calls up the next info page and continuously holding it scrolls cyclically all info pages.

Available info fields (quadrants) for displaying information on the info pages:

 Page 1 / Top left	 Page 1 / Top right
 Page 1 / Bottom left	 Page 1 / Bottom right
 Page 2 / Top left	 Page 2 / Top right
 Page 2 / Bottom left	 Page 2 / Bottom right
 Page 3 / Top left	 Page 3 / Top right
 Page 3 / Bottom left	 Page 3 / Bottom right
...	

Some applications already display the most usual information, but you may reconfigure the info pages at any time. Therefore switch the menu item „Info fields“ in the context menu of the application and assign the info fields individually.

Example:

- Hold «MENU» to switch the home screen.
- Switch for instance the icon Weighing by pressing the correspondent {▲}.
- Press «MENU» to switch the context menu.
- Keep pressing {▼} until the menu item „Info fields“ is selected.
- Press {↵} to define the utility Info fields.

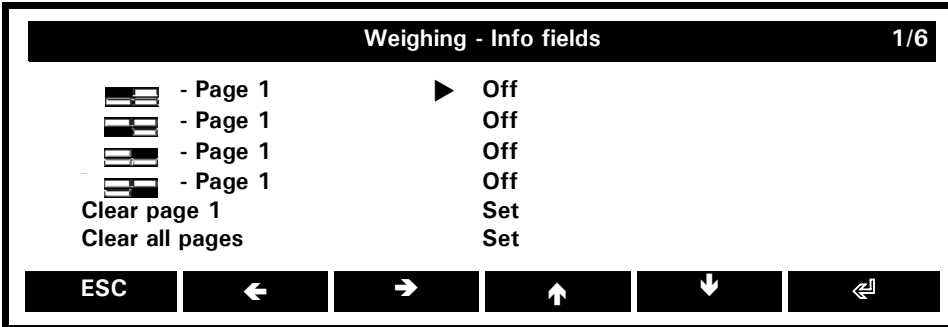

- Switch the selected menu item by pressing {↵}.
- Select the list box item „Net“ and assign it by pressing {↵}.

Continue until the following settings will be made:

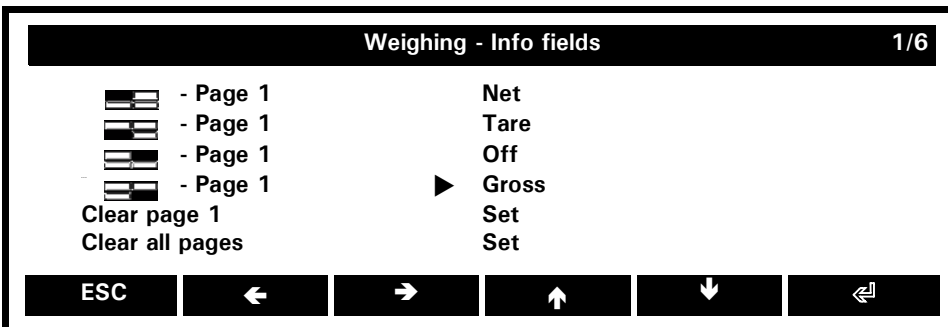

- return to the current application Weighing by pressing {ESC}, {ESC}.
- Now observe the info page while you weigh, tare and so on.

12.3.2.1 Available basic info field items

The following info field items are of general nature and therefore not linked to single power functions or applications. They may be available in various info field select lists:

Tare: Off
Tare weight

Net: Off
Net weight

Gross: Off
Gross weight

12.3.3 Utility: Protocol

A protocol printout consists of three sections: a header, a footer and a midsection. The header and the footer are of general nature and therefore defined in the configuration menu, see chapter 10.4 "Configuration - Protocol".

The utility Protocol is to define the midsection to be printed out. This midsection can consist of various numbered positions. Each position, if called up in order to define it, offers the whole range of items in a list box.

■ 12 Applications and Functions

- Hold «MENU» to switch the home screen.
- Switch for instance the icon „Weighing“ by pressing the correspondent {▲}.
- Press «MENU» to switch the context menu.
- Keep pressing {▼} until the menu item „Protocol“ is selected.
- Press {↵} to switch the utility Protocol.

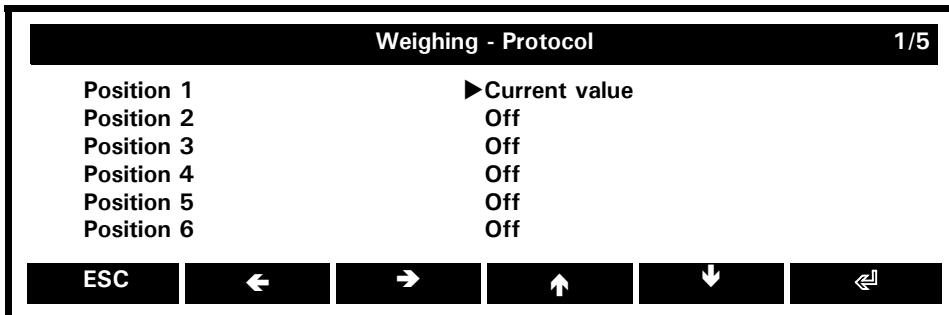

...

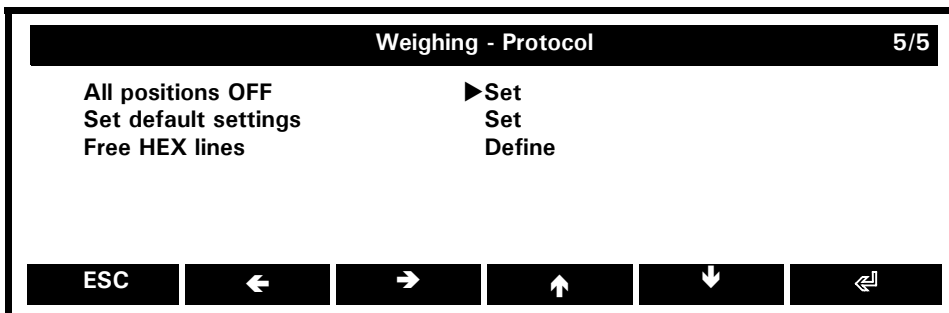
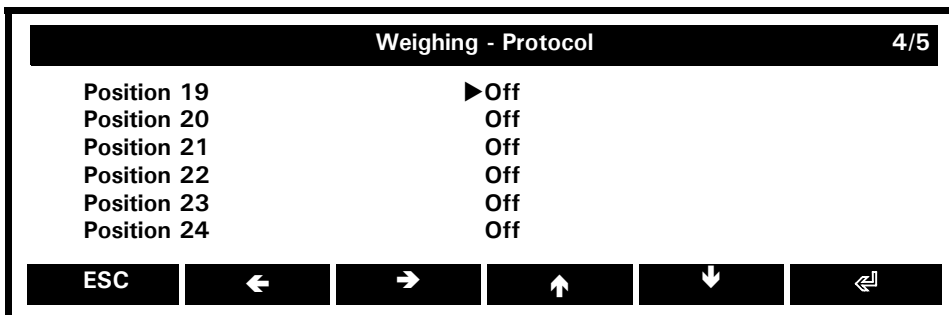

Position i: Current value

Assigns a protocol item out of a list box to the position *i* of the protocol midsection.

Set default settings: Set

Sets all protocol positions of the midsection to the default settings by pressing {↵}.

Free HEX lines: Define

Defines the hexadecimal output for the midsection. This function works the same way it does in the configuration menu for the header/footer, learn more in chapter 10.4.4.2 "Configuration - Protocol - Header/Footer - Free HEX lines"

12.3.3.1 Available basic protocol items:

The following basic protocol items are of general nature and therefore not linked to single power functions or applications. They may be available in various protocol item select lists:

Name and Brief Information	How it Looks in the Printout (Example)
Off <i>Disables the selected position</i>	<i>„No printout“</i>
Current value <i>(By default assigned to position 1) As defined in the configuration menu, see chapter 10.4.3 "Configuration - Protocol - Value format"</i>	0.00 g
... : Tare <i>Tare weight with text</i>	Tare : 0.00 g
... : Net <i>Net weight with text</i>	Net : 0.00 g
... : Gross <i>Gross weight with text</i>	Gross : 0.00 g
HEX Line 1 ... 4 <i>Prints out the content of the corresponding chosen free Hex line (1 ... 4), as described in chapter 10.4.4.2 "Configuration - Protocol - Header/Footer - Free HEX lines"</i>	<i>„Free HEX line“</i>
Linefeed <i>Prints out an empty line</i>	<i>„Empty line“</i>
Underline <i>Prints out an underline</i>	-----

12.4 Applications

! NOTE

Customizing an application includes also the possibility to change the settings of the soft keys, the info fields and the protocol. For this purpose a utility consists always of the following items:

- *Application specific items.* They are particular and available only defining them in their relative application.
- *Common items.* defining They are power function specific and always listed at large. In this case the utility acts as a pool of them, what allows you to have them defined in advance and already available as soon as you enable the relative power function.
- *Basic items.* They are of general nature and therefore linked neither to single power functions nor to applications. They are listed at large too and may be available in various protocol item select lists.

However, in this chapter only the application specific utility items are discussed. For the common and the basic items, refer to their relative chapters 12.2 "Power Functions" and 12.3 "Utilities".

12.4.1 Application: Weighing

The application Weighing acts as basic balance application and consists only of power functions, utilities and the info window to show the properties.

- Hold «MENU» to switch the home screen.
- Switch the icon „Weighing“ by pressing the correspondent {▲}.
- Press «MENU» to switch the context menu.

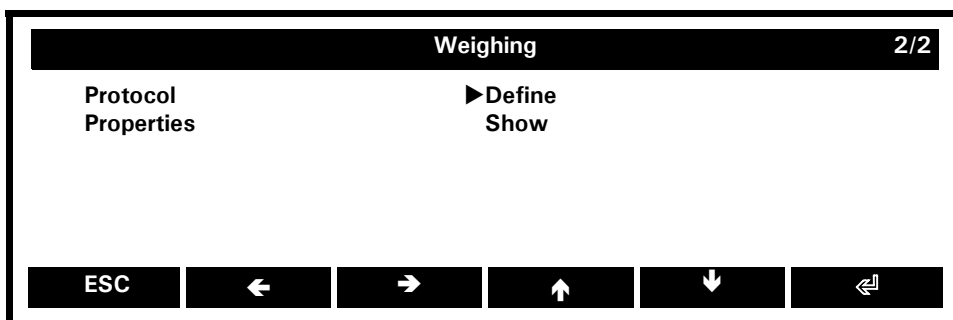
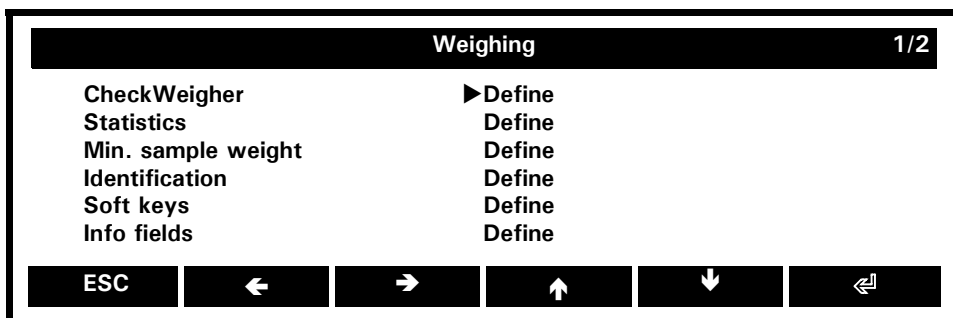

Application specific functions:

None

By default assigned and available (off) specific soft key functions:

None

By default assigned and available (off) specific info fields:

None

By default assigned and available (off) specific protocol items:

None

12.4.2 Application: Piece Counting

With the aid of the application Piece Counting you can count items of uniform weight (screws, bearings, coins, etc.).

For this, you must first weigh a defined number of items (for example 5 items) and assign the reference number of pieces to the reference weight so obtained by pressing the corresponding function key.



NOTE

Depending on the weight and tolerances of the objects to be counted, you should count a representative number of items for the regulation of the reference-weight.

- Hold «MENU» to switch the home screen.
- Switch the icon „Piece Counting“ by pressing the correspondent {▲}.
- Press «MENU» to switch the context menu.

Application specific settings:

Piece Counting		1/3
FixPcs 1	►5	
FixPcs 2	10	
FixPcs 3	25	
FixPcs 4	50	
Show basic unit	On	
...		
ESC	←	→
	↑	↓
		↶

FixPcs 1: 5

Sets the reference-number of pieces = 5 for this soft key

FixPcs 2: 10

Sets the reference-number of pieces = 10 for this soft key

FixPcs 3: 25

Sets the reference-number of pieces = 25 for this soft key

FixPcs 4: 50

Sets the reference-number of pieces = 50 for this soft key

Show basic unit: On, Off

Enables/Disables the secondary display with the basic unit

By default assigned and available (off) specific soft key functions:

Fix Pcs 1: no.1

The current weight is recalculated in pieces (PCS) and displayed according to the reference-number of pieces set for this soft key

Fix Pcs 2: Off

The current weight is recalculated in pieces (PCS) and displayed according to the reference-number of pieces set for this soft key

Fix Pcs 3: Off

The current weight is recalculated in pieces (PCS) and displayed according to the reference-number of pieces set for this soft key

Fix Pcs 4: Off

The current weight is recalculated in pieces (PCS) and displayed according to the reference-number of pieces set for this soft key

VarPcs: no. 2

Manually input the number of pieces to recalculate the current weight for the reference weight of 1 piece

PcsWgt: Off

Manually input the reference weight of 1 piece

■ 12 Applications and Functions

Clr Pcs: no. 3

Clear reference for piece counting, switch back to basic unit

By default assigned and available (off) specific info fields:

PcsWgt: Page1 - Top right

Current reference weight of 1 piece

RefPcs: Page1 - Bottom right

Number of pieces used for the calculation of the reference weight

By default assigned and available (off) protocol items:

Name and Brief Information	How it Looks in the Printout (Example)
... : PcsWgt <i>Off (not assigned)</i> <i>Weight of 1 piece</i>	PcsWgt : 7.5543 g
... : RefPcs <i>Off (Not assigned)</i> <i>Number of pieces out of which the weight of 1 piece has been calculated</i>	RefPcs : 5 PCS
... : Net (App.Unit) <i>Off (not assigned)</i> <i>Net weight in the application specific unit (here PCS) with text</i>	Net : 100 PCS

12.4.3 Application: Percent Weighing

With the aid of the application Percent Weighing you can display and print out values as a percentage of a previously defined reference weight.

- Hold «MENU» to switch the home screen.
- Switch the icon „Percent Weighing“ by pressing the correspondent {▲}.
- Press «MENU» to switch the context menu.

Application specific settings:

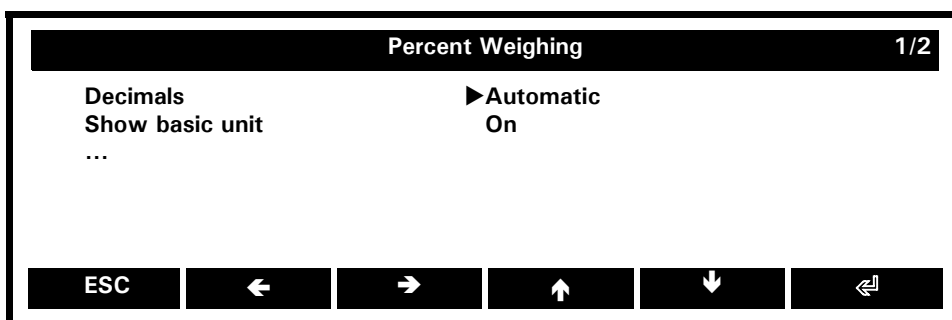

Decimals: Automatic, 0, 1, 2, 3, 4

Automatic calculation of places after the decimal point or select a number. The number of places that can be selected depends on the balance model.

Show basic unit: On, Off

Enables/disables the secondary display with the basic unit

By default assigned and available (off) specific soft key functions:

Set 100%: no. 1

Sets the current value as 100%

Set Var%: no. 2

Sets the current value as free definable percentage

Clr %: no. 3

Clears % as unit and displays the value in the basic unit

By default assigned and available (off) specific info fields:

Reference: Page1 - Top right

Weight that corresponds with the defined percentage under Reference%

Reference%: Page1 - Bottom right

Defined percentage

By default assigned and available (off) protocol items:

Name and Brief Information	How it Looks in the Printout (Example)
... : Reference Off (not assigned) Weight that corresponds with the defined percentage	Ref : + 122.23 g
... : Reference% Off (not assigned) Defined percentage	Ref% : + 100.000 %
... : Net (App.-U) Off (not assigned) Net weight in the application specific unit (here %) with text	Net : + 100.189 %

12.4.4 Application: Units Conversion

With the aid of the application Units Conversion you can display and print out the measuring result in different units, see also chapter 10.2 "Configuration - Weighing parameters".

- Hold «MENU» to switch the home screen.
- Switch the icon „Units“ by pressing the correspondent {▲}.
- Press «MENU» to switch the context menu.

Application specific settings:

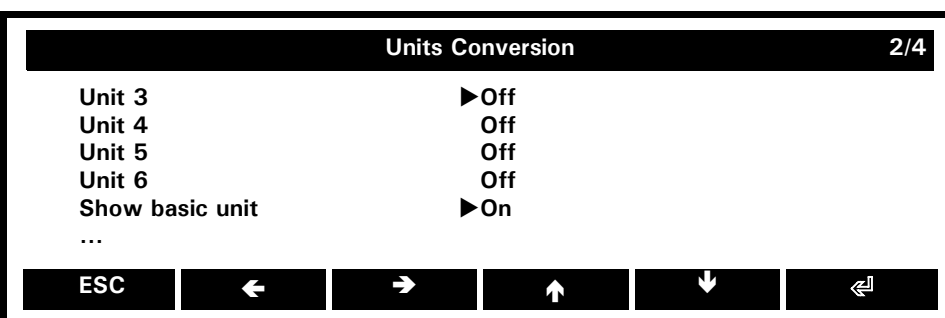
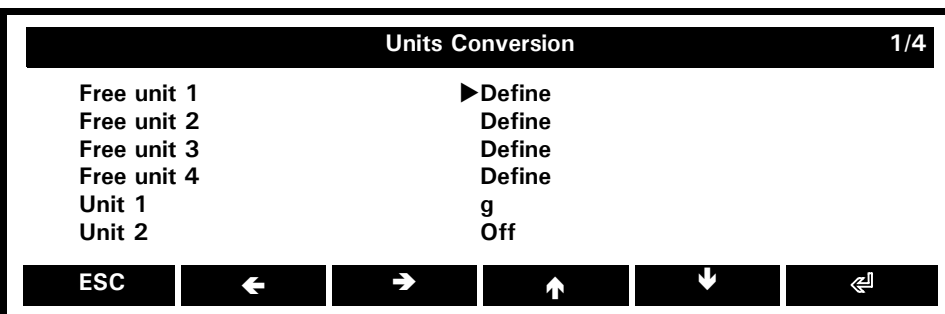

■ 12 Applications and Functions

Free unit 1/2/3/4: Define

Defines a free unit in which to display the measuring result, see below under **defining a free unit**

Unit 1/2/3/4/5/6: Off, g, mg, kg, ..., baht

Selects a unit in which to display the measuring result, see also chapter 10.2 "Configuration - Weighing parameters".

Show basic unit: On, Off

Enables/disables the secondary display with the basic unit

Defining a free unit:

Units Conversion - Free unit 1/2/3/4	
Free unit	▶ Off
Name	U1
Calculation mode	F x Net
Factor (F)	1.0000000000
Decimals	0
Step	1

ESC ← → ↑ ↓ ↵

Free unit: On, Off

Enables/disables the chosen free unit

Name: U1

Defines a name for the chosen free unit

Calculation mode: F x Net, F / Net

Free unit = Factor (see next item) x net value in g

Free unit = Factor (see next item) / net value in g

Factor (F): 1.0000000000

Freely definable factor

Decimals: 0, 1, 2, 3, 4, 5

Number of decimals

Step: 1, 2, 5, 10, 20, 50

Step size

By default assigned and available (off) specific soft key functions:

Unit 1: no. 1

Displays the measuring result in unit 1 which by default is set to g, see above under **application specific settings**, context menu.

Unit 2: no. 2

Displays the measuring result in unit 2 which by default is set off, see above under **application specific settings**, context menu.

By default assigned and available (off) specific info fields:

None

By default assigned and available (off) protocol items:

Name and Brief Information	How it Looks in the Printout (Example)
... : Net (App.-U) Off (not assigned) Net weight in the application specific unit (here ct) with text	Net : + 500.00 ct

12.4.5 Application: Dynamic Weighing

The dynamic weighing workflow supports accurate weighing under unstable circumstances, e.g. on board ships, or weighing animals. During the period of measurement, defined by the user, the balance measures continuously, calculates the mean of all saved values at the end of the measuring period and indicates the resulting average value.

- Hold «MENU» to switch the home screen.
- Press {↓} to scroll down to the next icon page.
- Switch the icon „Dynamic weighing“ by pressing the correspondent {▲}.
- Press «MENU» to switch the context menu.

Application specific settings:

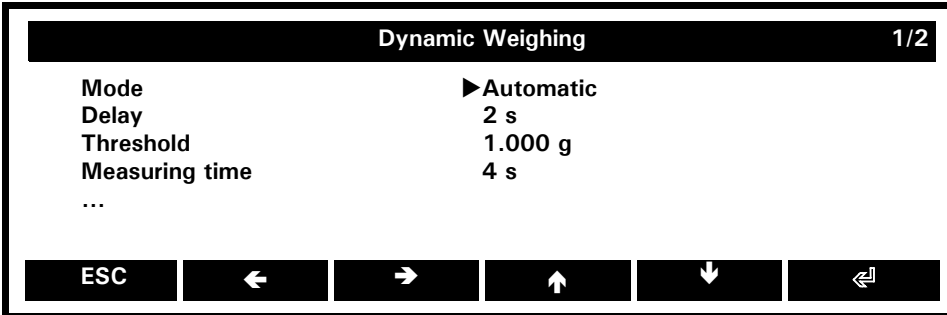

Mode: Manual, **Automatic**
Manual or automatic activation of the measurement

[Delay: 2 s]
(only available in Mode: Automatic)
Delay time for the automatic activation of the measurement

Limit: 1.000 g
Threshold to begin the measurement

Measuring time: 4 s
Time of one measuring period

By default assigned and available (off) specific soft key functions:

Start/Quit: no. 1
Activates/interrupts a dynamic weighing period

Set mode: Off
Changes between automatic and manual mode

Measuring time: Off
Sets the time of one measuring period

Dynamic tare: Off
Determines an average tare over one measuring time period

By default assigned and available (off) specific info fields:

None

By default assigned and available (off) protocol items:

Name and Brief Information	How it Looks in the Printout (Example)
... : Net (App.-U) <i>Off (not assigned)</i> <i>Calculated (o) average net weight in the basic unit (g) with text</i>	Net : o + 102.57 g

■ 12 Applications and Functions

12.4.6 Application: Automatic Repeatability Test ART

The automatic repeatability test ART provides you with a quick and easy way to get a statement about the quality of your working location. To run this application

- Hold «**MENU**» to switch the home screen.
- Press {**↓**} twice to scroll down to the last icon page.
- Switch the icon „Auto. Repeatability Test“ by pressing the correspondent {**▲**}.
- Press {**START**} to start the automatic repeatability test.

The balance now measures ten times its internal calibration weight, calculates the standard deviation and logs the result in an info window.

In case of an unsatisfying report, check out the conditions of your working circumstances as described in chapter 6.4 "Choosing a Suitable Location".

Application specific functions:



START: This soft key function is always assigned and permanently fixed on the right end of the function bar whenever the application Auto. Repeatability Test is running.

Starts the automatic repeatability test and becomes EXIT.



EXIT: This soft key function is always assigned and permanently fixed on the right end of the function bar whenever the application Auto. Repeatability Test is running and executing.

Aborts the automatic repeatability test and becomes START again.

By default assigned and available (off) specific soft key functions:

START/EXIT:

Starts/aborts the automatic repeatability test

By default assigned and available (off) specific info fields:

None

By default assigned and available (off) protocol items:

None

13 Data Transfer

For data-transfers to peripheral devices, the balance is equipped with an RS232/V24-interface.

Before the data-transfer, the RS232 interface must be matched with the one in the peripheral device in the balance configuration menu (see chapter 10.5 "Configuration - Interface").

- **Handshake**

The handshake is set to „NO“ (none) at the factory. It can be set to software handshake „XON-XOFF“, or to hardware handshake „HARDWARE“.

- **Baud rate**

Possible baud rates: 300, 600, 1200, 2400, 4800, 9600, 19200, 38400, 57600 baud.

- **Parity**

Possible parity: 7 even 1 stop, 7 odd 1 stop, 7 no 2 stop, 8 no 1 stop, 8 even 1 stop, 8 odd 1 stop.

Pos.	0	1	2	3	4	5	6	7	8	9	10
7-even-1	SB	1.DA	2.DA	3.DA	4.DA	5.DA	6.DA	7.DA	PB	SP	-
7-odd-1	SB	1.DA	2.DA	3.DA	4.DA	5.DA	6.DA	7.DA	PB	SP	-
7-no-2	SB	1.DA	2.DA	3.DA	4.DA	5.DA	6.DA	7.DA	1.SP	2.SP	-
8-no-1	SB	1.DA	2.DA	3.DA	4.DA	5.DA	6.DA	7.DA	8.DA	SP	-
8-even-1	SB	1.DA	2.DA	3.DA	4.DA	5.DA	6.DA	7.DA	8.DA	PB	SP
8-odd-1	SB	1.DA	2.DA	3.DA	4.DA	5.DA	6.DA	7.DA	8.DA	PB	SP

SB: Start bit PB: Parity bit
DA: Data bit SP: Stop bit

- **Display**

S	D7	D6	D5	D4	D3	D2	D1	D0	U	U	U
---	----	----	----	----	----	----	----	----	---	---	---

The data-transfer takes place in ASCII code. The standard value format is as follows:

1	2	3	4	5	6	7	8	9	10	11	12	13	14	15
B	B	B	S	D7	D6	D5	D4	D3	D2	D1	DP	D0	B	U	...	CR	LF

B Blank (space)
S Sign (+, -, space)
DP Decimal point
D0...D7 Digits
U ... Unit (only if the weight is stable, otherwise no unit is send)
CR Carriage return
LF Line feed



NOTE

Unused positions are filled with spaces. The decimal point DP can be between D0 and D7.
If the value format is user defined the format is not as mentioned above!

13.1 Connection scheme

- **Standard duplex connection**

Balance	DB 9 female	D25 / D9	Peripheral device
RS 232 out	2	→ 3 / 2	RS 232 in
RS 232 in	3	← 2 / 3	RS 232 out
GND	5	— 7 / 5	GND

■ 13 Data Transfer

- Standard, duplex connection with additional hardware handshake in the peripheral device

Balance	DB 9 female	D25 / D9	Peripheral device
RS 232 out	2 \longrightarrow	3 / 2	RS 232 in
RS 232 in	3 \longleftarrow	2 / 3	RS 232 out
GND	5 \longrightarrow	7 / 5	GND
CTS	4 \longleftarrow	20 / 4	DTR
DTR	8 \longrightarrow	5 / 8	CTS

13.2 Remote control-commands

Command	Function
ACKn	Acknowledge n=0 off; n = 1 on
CAL	Start calibration
D.....	Describe upper info pasge area
DN	Reset upper info pasge area
@.....	Describe lower info pasge area
@N	Reset lower info pasge area
In	Set refresh rate n n = 0 fast n = 1 normal n = 2 slow n = 3 extra slow
N	Reset balance
OFF	Switch off balance
ON	Switch on balance
PCxxxx	Enter anti-theft code
PDT	Print out date and time
PRT	Start printing (Press « PRINT » key)
PST	Start print status of current user
Pn (ttt.t)	Set print mode n = 0 Individually print each value (unstable) n = 1 Individually print each value (stable) n = 2 Print after change of load n = 3 Print after each integration period n = 4 Print on time basis in s (ttt.t)
R%k	Set current weight = 100% with k=0...7 decimal places (k=A: use automatic positioning of decimal point)
REF%k rrr	Set reference weight rrr for 100% with k=0...7 decimal places (k=A: use automatic positioning of decimal point)
Rnnn	Set current weight = nnn items
REFrrr	Set reference weight rrr for 1 item
Sn	Set stability n n = 0 low n = 1 medium n = 2 high
SDTttmmjj hhmmss	Set date and time (German) (Tag, Monat, Jahr, Stunde, Minute, Sekunde)
SDTmmddyy hhmmss	Set Date and Time (English) (Month, Day, Year, Hour, Minutes, Seconds)
T (ttt)	Tare or set tare to a specific value
Uxnn	Set unit x (1...4) of the balance with nn (0=g, 1=mg, 2=kg, ...)
UxS	Switch balance to unit x (1...4)
ZERO	Zero balance (provided weight is stable and within the zero position range)

**NOTE**

Each remote control-command must terminate with «CR» «LF». The commands are acknowledged if required.

13.2.1 Examples for the remote control

Input	Description of the function executed
D - - - - -	Five dashes are displayd
DTEST123	TEST123 is displayd
D	The display is dark
T100	-100.000 g (Tare set to 100 g)
T1	-1.000 g (Tare set to 1g)
T	Balance is tared

14 Maintenance and Servicing

14.1 Calibration

The calibration of the balance is fixed in the Configuration menu (6.7 "Calibration of the Balance" and 10.3 "Configuration - Calibration").

Possible types of calibration, depending on the model of balance:

- External calibration by means of ICM (Intelligent Calibration Mode)
- External calibration with freely selectable weight
- Internal calibration
- Automatic calibration

! NOTE

The calibration can be interrupted at any time by pressing «ON/OFF».

To manually perform a calibration proceed as follows:

- Switch to the application „Weighing“.
- Press «0/T» until the calibration menu is shown.
- Select „Calibration“ and press {←}

The calibration starts.

14.1.1 External Calibration

Depending on the type of balance, calibration weights in steps of 10 g, 50 g, 100 g, 500 g or 1000 g can be used, where the calibration weight must correspond to the precision of the balance.

For external calibration with user-definable weight, „Calibration Mode = External“ must be selected in the Configuration menu (see chapter 10.3 "Configuration - Calibration").

Start the calibration:

Display	Step
<div style="border: 1px solid black; padding: 5px; background-color: #f0f0f0;"> <p style="text-align: center;">- - - -</p> <p style="text-align: center;">... Measuring zero ...</p> </div>	<p>The balance carries out a Zero measurement „- - - - g“ is shown flashing).</p>
<div style="border: 1px solid black; padding: 5px; background-color: #f0f0f0;"> <p style="text-align: center;">- - 1 0 0 0 g</p> <p style="text-align: center;">... Measuring external weight ...</p> </div>	<p>After the zero measurement the display flashes with the recommended calibration weight.</p>
<div style="border: 1px solid black; padding: 5px; background-color: #f0f0f0;"> <p style="text-align: center;">- - 1 0 0 0 g</p> <p style="text-align: center;">... Measuring external weight ...</p> </div>	<p>Place the calibration weight on the weighing pan. The display continuous to flash.</p>
<div style="border: 1px solid black; padding: 5px; background-color: #f0f0f0;"> <p style="text-align: center;">1 0 0 0, 0 0 0 g</p> </div>	<p>Calibration is complete when the display stops flashing</p>

14.1.2 External Calibration with Freely Selectable Weight



For external calibration with user-definable weight, „Calibration Mode = External Def.-Weight“ must be selected in the Configuration menu (see chapter 10.3 "Configuration - Calibration").

Then, the effective value of the calibration weight (Def.-Weight = n.nnn g) must be entered with up to ten-fold precision compared with the balance.

! NOTE

If calibration is carried out with the free weight, then only this weight may be used.

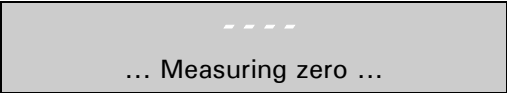
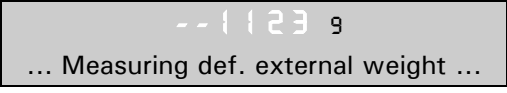
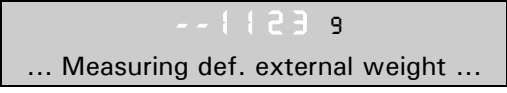
Start the calibration:

Display	Step
	The balance carries out a Zero measurement „- - - - g“ is shown flashing.
	After the zero measurement the display flashes with the recommended calibration weight.
	Place the calibration weight on the weighing pan. The display continuous to flash.
	Calibration is complete when the display stops flashing

14.1.3 Internal calibration

For internal calibration with the built-in calibration weight „Calibration Mode = Internal“ must be selected in the Configuration menu (see chapter 10.3 "Configuration - Calibration").

- Switch to the application „Weighing“.
- Press «O/T» until the calibration menu is shown.
- Select „Calibration“ and press {←}

The calibration starts and finishes after a certain period of time.

14.1.4 Automatic Calibration

For automatic calibration with the built-in calibration weight „Calibration Mode = Automatic“ must be selected in the Configuration menu (see chapter 10.3 "Configuration - Calibration").

The balance now calibrates itself automatically every 24 hours at the set time (e.g. 06:00:00 for 06.00 o'clock in the morning) and/or after each temperature change of the selected value in degrees Celsius (e.g. 2 Temp for 2 degrees Celsius), depending on the definition in the Configuration menu.

! NOTE

For automatic calibration by time and by time/temp. the date and time of the balance must first be correctly set (see chapter 10.7 "Configuration - Date/Time").

Calibration can also be effected manually at any time when auto-calibration is activated.

Automatic calibration then takes place only if no weight has been placed on the pan for at least five minutes.

It is recommended that the time for auto-calibration be set outside the normal business hours (for example, in the early morning).

14.2 Software Update

Our balances are instruments which are being continuously advanced and improved. For this reason, it is possible to update to the latest version of the instrument software via the internet.

In order to update your software, you need to download the Download Tool from the website and install it onto a PC with Windows.

The software for the balance can also be downloaded from the Downloads area on the website. This can then be loaded into the instrument with the aid of the download tool.

14.3 Cleaning

The balance must be treated carefully and cleaned regularly. It is a precision instrument.

DANGER

For maintenance work, the balance must be separated from the power supply (remove power adaptor plug from socket). Also ensure that the balance cannot be reconnected to the power supply during the work by a third party.

Take care during cleaning that no liquid penetrates into the appliance. If liquid is spilt on the balance, the latter must immediately be disconnected from the electricity supply. The balance must only be used again after it has first been checked by a Service Engineer.

The connections on the rear of the appliance and the power adaptor must not come into contact with liquids.

Regularly dismantle the weighing pan and the weighing pan holder and remove any dirt or dust from under the weighing pan and on the balance housing with a soft brush or a soft, lint-free cloth, moistened with a mild soap solution.

The weighing pan and the holder can be cleaned under running water. Take care that both parts are completely dry before re-installing them on the balance.

CAUTION

Never use solvents, acids, alkalis, paint thinners, scouring powders or other aggressive or corrosive chemicals for cleaning, since these substances attack the surfaces of the balance housing and can cause damage.

The regular maintenance of the balance by your Service Representative will guarantee unlimited function and reliability over many years and will extend the lifespan of the balance.

14.4 Error Messages

The balance shows a description of the fault in the info-line.

NOTE

If an error occurs without a description of the error in the info-line, the Customer Service must be called.

14.4.1 Notes on Correcting Faults

The following table shows faults and their possible causes. If you cannot clear the fault using the table, please contact the Customer Service..

Fault	Possible Cause
Weight display does not light	<ul style="list-style-type: none"> • Balance not switched on • Connection to power adaptor is interrupted • Power supply has failed (interruption to current) • The power adaptor is defective
"OL" is shown in display	<ul style="list-style-type: none"> • The weight range has been exceeded (Observe information on the maximum weight range)
"UL" is shown in display	<ul style="list-style-type: none"> • The weight range is below the range of the balance (Scale pan or scale pan holder missing)
The weight display fluctuates continuously	<ul style="list-style-type: none"> • The draft is too strong at the balance location • The balance support is vibrating or varying • The scale pan is touching a foreign body • The refresh rate chosen for is too fast • The material being weighed is absorbing moisture • The material being weighed is being blown away or is evaporating • Strong temperature variations in the material being weighed

Fault	Possible Cause
Results of weighing are clearly incorrect	<ul style="list-style-type: none"> • The balance was not correctly tared • The balance is not correctly levelled • The calibration is no longer correct • There are strong temperature variations
There is no display or only dashes	<ul style="list-style-type: none"> • The stability control (Balance functions) is set too sensitively • The time selected for „FLOATINGDISPLAY“ is unsatisfactory
Configuration menu cannot be changed	<ul style="list-style-type: none"> • The password lock is activated in the configuration menu
The display flashes continuously during calibration	<ul style="list-style-type: none"> • The balance location is not stable enough (Interrupt calibration with «ON/OFF» and relocate the balance in a better position) • Use of an imprecise calibration weight (only applies to external calibration)

15 Additional Information

The balance can show results in different units, although with some balances display is not possible in milligram or kilogram because of the corresponding weight range.

Display	Weight Unit	Conversion to Gram
g	Gram	
(mg)	Milligram	0,001 g
(kg)	Kilogram	1000 g
GN	Grain	0,06479891 g
dwt	Pennyweight	1,555174 g
ozt	Troy ounce	31,10347 g
oz	Ounce	28,34952 g
Lb	Pound	453,59237 g
ct	Carat	0,2 g
C.M.	Carat Metric	0,2 g
tLH	Tael Hong Kong	37,4290 g
tLM	Tael Malaysia	37,799366256 g
tLT	Tael Taiwan	37,5 g
mo	Momme	3,75 g
t	Tola	11.6638038 g
Bht	Baht	15.2 g

