



PROTEKT PROTOPIA™

Long Term Care Bed

36" Fixed Width

80"/84"/88" Adjustable Length

Model: PMLTC36



User Manual

270 Washington Street
Mount Vernon, NY 10553
855-237-7622
www.proactivemedical.com

Proactive Medical Products
270 Washington Street
Mount Vernon, NY 10553
855-237-7622
www.proactivemedical.com

The information presented in this manual is confidential and may not be reproduced or disclosed in any form or by any means without the prior written permission of Proactive Medical Products.

Proactive Medical Products reserves the right to make changes to the design, characteristics and models without prior notice. The only warranty provided by Proactive Medical Products is the express written warranty offered upon the sale of its products.

For ordering additional copies of this user manual, please refer to the final page.

©2023 by Proactive Medical Products. ALL RIGHTS RESERVED.

Table of Contents

General Information	1
Symbol definitions	1
Intended Use	2
Safety Precautions	2
Unpacking the Bed	2
Assembling the Bed.....	2
Operating the Bed.....	3
Performing Maintenance.....	4
Electrical and Earthing	4
Radio Frequency and Interference	5
Disposal	5
Reducing the Risk of Entrapment.....	6
Steps to Prevent Bed Fires.....	7
Technical Specifications	8
Equipment Assembly	9
Handling Procedures	9
Components	10
Assembling the Bed	11
Assembling the Head/Footboard Brackets to the Bed.....	11
Assembling the Head/Footboard	11
Installing the Mattress Retainer	12
Installing the Wall Bumper Bar	12
Installing the Rails or Assist Bars.....	13
Connecting the Control Box	15
Installing Battery Backup (Optional Accessory)	15
Equipment Operation	16
Positioning the Bed	16
Extend the Length of the Bed from 80” to 84” or 88”	17
Using the Hand Pendant	18
Operating the Bedrails (Optional Accessory)	19
Trouble Shooting Guide	20
Limited Warranty	21
Appendix	22
Service record.....	22

General Information

Symbol definitions

Signal words with symbols are used in this manual to improve readability and increase understanding of its content. These symbols are also designed to highlight hazards or unsafe practices which could result in personal injury or property damage.

- ♦ Standard text - Normal character style used for “basic” information.
- ♦ **Boldface text** - Emphasize a word or phrase.
- ♦ Symbols - Represent different risks or hazards and information.

 **DANGER**
Danger indicates an imminently hazardous situation which, if not avoided, will result in death or severe injury.

 **WARNING**
Warning indicates a potentially hazardous situation which, if not avoided could result in death or severe injury.

 **CAUTION**
Caution indicates a potentially hazardous situation which, if not avoided, may result in property damage or minor injury or both.

 **IMPORTANT**
Indicates a hazardous situation that could result in damage to equipment or property if it is not avoided.

 **INFORMATION**
Gives useful tips, recommendations and information for ease of use.

Intended Use

The Protekt Protopia™ Long Term Care Bed is intended for use within an institutional healthcare environment, i.e., nursing homes, rehabilitation care, assisted living.

The bed is not a transport device. The wheels on the bed are for positioning the bed only. These shall be locked at all times when in use.

Safety Precautions



WARNING

Before using the bed, thoroughly read the instructions in this user manual. This manual provides instructions for routine use and maintenance.

Unpacking the Bed



To avoid injury, do not attempt to remove the bed from the carton without assistance.

Assembling the Bed



WARNING

Make sure all attaching hardware is securely tightened.

Do not overtighten the mounting hardware as this will damage the mounting brackets.

Do not modify this equipment without authorization of the manufacturer. Doing so will void the warranty.

Do not use accessories that are not designed or approved for use with the bed.

Operating the Bed



WARNING

Do not operate your bed until it is fully assembled and checked. Do not exceed maximum weight limitations of the bed.

Always make sure the power cable is clear of any moving parts of the bed before switching on the power.

Always keep hands and fingers away from moving parts to avoid injury.

Only use appropriate mattresses and always adjust the mattress retainer system accordingly to ensure the mattress is fixed in place.

The mattress must be properly sized to meet entrapment zone dimensional guidelines published by the FDA. For a full listing of products/mattresses, please visit our website at www.proactivemedical.com.

The mattress platform shall be kept in a flat position if the patient's condition could lead to patient entrapment.

Never permit anyone under the bed at any time.

Do not use side rails as handles to move the bed.

The side rails may not be used as a restraint.

When operating/moving the bed, ensure that the resident is positioned properly within the confines of the bed. Do not let any extremities protrude over the side or between the rails when performing these functions. Keep all moving parts free from obstruction (i.e., blankets/sheets, pads, tubing, etc.) which may get tangled around the bed, side rails, or legs.

When using nasal or masked type administering equipment, oxygen or air tubing must be routed and secured properly to ensure tubing does not become entangled, kinked, or severed during normal operation of the bed.

For maximum resident safety, casters should be locked at all times, except when moving the bed.

Performing Maintenance



Only qualified personnel should carry out the bed maintenance.

Do not attempt to open the pre-sealed actuator or obtain local service. Doing such will void the warranty and might result in damage. Consult your dealer or manufacturer for further information.

Inspect the casters every six months to check for tightness and wear.

Regular maintenance of bed and accessories is necessary to ensure proper operation. Do not overtighten mounting hardware. This will damage mounting brackets.

Unplug the power cord when performing any maintenance on the bed.

Electrical and Earthing



Do not, under any circumstances, cut or remove the earthing prong from any plug. Some devices are equipped with three-prong (earthing) plugs for protection against possible shock hazards. Where a two-prong wall receptacle is encountered, it is the personal responsibility and obligation of the customer to contact a qualified electrician and have the two-prong receptacle replaced with a properly earthed three-prong wall receptacle in accordance with the regional and national regulations. If you must use an extension cable, use only a three-wire extension cable having the same or higher electrical rating as the device being connected.

Do not use if the power cable is cut, frayed or loosely connected to the device. Power supply cable may be damaged by inappropriate handling, e.g., by kinking, shearing or other mechanical damages. The power supply cable is only replaceable by service personnel.

Radio Frequency and Interference



WARNING

Most electronic equipment is influenced by Radio Frequency Interference (RFI). Caution should be exercised with regard to the use of portable communication equipment in the area around such equipment. If RFI causes erratic behavior, switch the power off immediately. Do not turn the power switch on while transmission is in progress.

Disposal



WARNING

This product has been supplied from an environmentally aware manufacturer.

This product may contain substances that could be harmful to the environment if disposed of in places that are not appropriate according to legislation.

Please be environmentally responsible and recycle this product through your recycling facility at its end of life.

Reducing the Risk of Entrapment



The Hospital Bed Safety Workgroup (HBSW) in partnership with the FDA has recognized potential entrapment zones in hospital bed systems and has developed dimensional guidance to reduce the risk of entrapment. They have identified seven zones in the bed system where there is a potential for patient entrapment. Entrapment may occur in flat or articulated bed positions, with the rails fully raised or in intermediate positions. Each facility is responsible for compliance with the entrapment guidelines. For more information about entrapment zones and guidelines please visit the FDA website.

ENTRAPMENT ZONES:

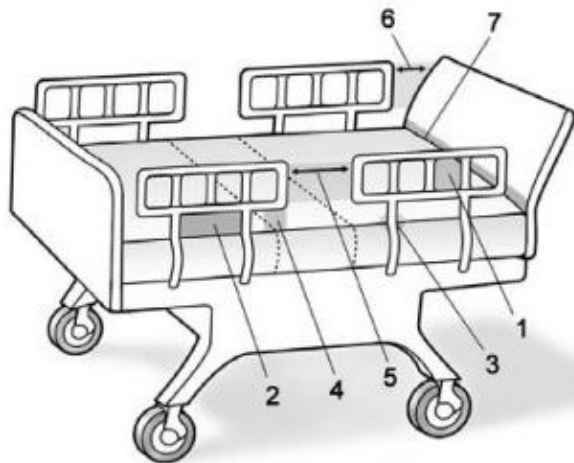

Zone 1: Within the rail

Zone 2: Between the top of the mattress and the bottom of the rail, between the rail supports

Zone 3: Between the rail and the side of the mattress

Zone 4: Between the top of the mattress and the bottom of the rail, at the end of the rail

Zone 5: Between the split bed rails

Zone 6: Between the end of the rail and the side edge of the headboard or footboard

Zone 7: Between the headboard or footboard and the mattress end

Steps to Prevent Bed Fires

- Inspect the bed's power cord for damage.
- Connect the power cord directly into a wall-mounted outlet that is in good working order, with no cracks or chips. The plug should fit tightly into the outlet. The ground pin should be intact and secure.
- Do not connect the bed's power cord to an extension cord or to a multiple-outlet strip.
- Do not cover any power cord with a rug. Heat may build up or the cord may be damaged.
- Inspect the floor beneath the bed for buildup of dust and lint. Ask housekeeping to clean if necessary.
- Inspect the resident's bed controls, looking for signs of damage where liquids could leak in.
- Test the bed and its controls, including resident lockout features, to ensure that the bed can move freely in both directions without damaging any cords.
- Check monitors and other resident equipment for signs of overheating or physical damage.
- Keep linens and clothes away from power sources.
- Tell maintenance staff about any unusual sounds, burning odors, or unusual movement of a bed.
- If you suspect overheating, follow your facility's policy for fire safety and move resident to a safe area if necessary.

Technical Specifications

These are average values, which may vary according to manufacturing tolerances.

Model PMLTC36		
OPERATING RANGE	Bed Height	7" – 31"
	Back Rest Angle	0° - 65°
	Knee Break Angle	0° - 35°
	Additional Manual Leg Lift	N/A
	Trendelenburg / Reverse Trendelenburg	N/A
WEIGHT LIMIT	Safe Working Load (SWL)	500 LBS
WEIGHTS & DIMENSIONS	Sleeping Surface Dimension Width x Length	36" x 80" ~ 84" ~ 88"
	Caster Size	3"
	Weight IN Carton	225 LBS
	Weight OUT of Carton	209 LBS
	Power Supply (V/PH/Hz)	100-240V / 1ph / 50-60Hz
	Power Consumption (Max)	240 W
ELECTRICS	Number of Motors	3
	Protection Class	IP54
	Insulation Class	II Type B
	Duty Cycle	10%, Max. 2 mins / 18 mins
	Battery backup	N/A
ENVIRONMENT	Operating Temperature	41°F ~ 113°F (5°C ~ 45°C)
	Storage Temperature	14°F ~ 122°F (-10°C ~ 50°C)
	Operation & Storage Humidity	20% - 80%
	Operation & Storage Atmospheric Pressure	86 ~ 1006 KPa
	Operation & Storage Altitude	≤ 3000 m
	Noise Level	≤ 52 dB

Equipment Assembly



CAUTION

Use only parts supplied by Proactive Medical Products for assembly to ensure correct alignment of all parts for safe operation.

Handling Procedures

Check for any obvious damage to the carton. If damage is evident, notify the carrier and the dealer.

Carefully unpack the components from the shipping cartons.

Inspect all components. Examine exterior of the bed and parts for nicks, dents, scratches or damages.

Unless the bed is to be used immediately, retain boxes, containers and packing material for use in storing until use of the bed is required.



CAUTION

Do not place other objects on top of the packaged bed.



Store the packaged bed in a dry area.

Components

Components Description	Piece
Bed Assembly	1
Headboard Frame	2
Footboard Frame	2
Bed-end Mattress Retainer	1
Mattress Retainer	4
Wall Bumper Bar	1



Bed Assembly x 1

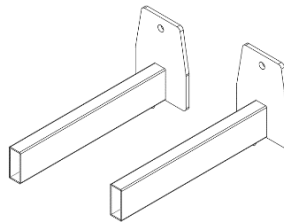

Headboard Frame x 2

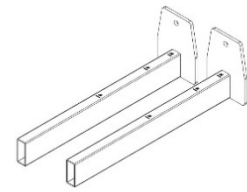

Footboard Frame x 2

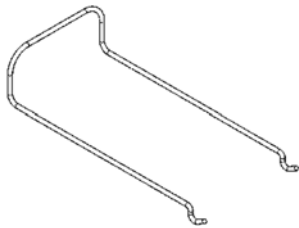

Mattress Retainers x 4

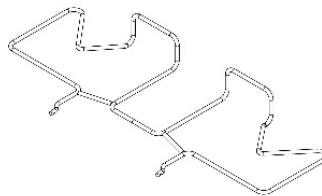

Bed-end Mattress Retainer x 1



Wall Bumper Bar x 1

Assembling the Bed

Assembling the Head/Footboard Brackets to the Bed

1. With the bed raised to its highest position, step on the locking levers to lock all casters.
2. Turn and loosen the two black knobs on the underside of the bed and insert the headboard brackets into their slots.
3. Slide and push the headboard brackets all the way into the slots. Tighten the black knob to secure the brackets in place.
4. Repeat the same procedure for the footboard bracket installation.

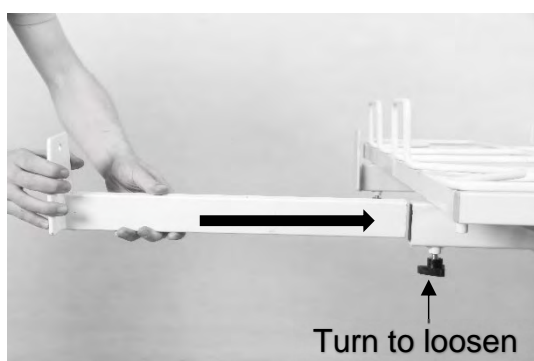

Assembling the Head/Footboard

1. With the mounting plates on the headboard facing the bed, slide the mounting plate groove onto the headboard mounting bracket's vertical support.
2. Insert the lock pin through the mounting plate into the headboard to secure the headboard in place. Repeat on the other mounting plate.
3. Repeat the same procedures for footboard installation.

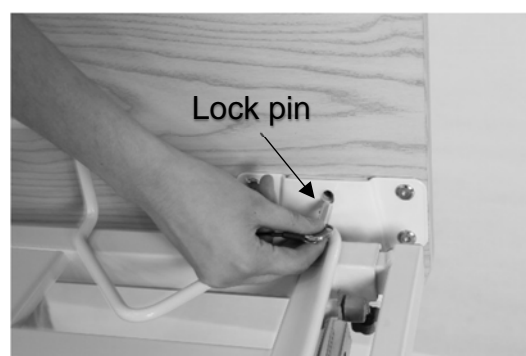

Installing the Mattress Retainer

1. Locate the mounting holes for the mattress retainers in the bed deck. Align and insert the mattress retaining wires through the precast holes.
2. Repeat the procedure for both sides including the head section.

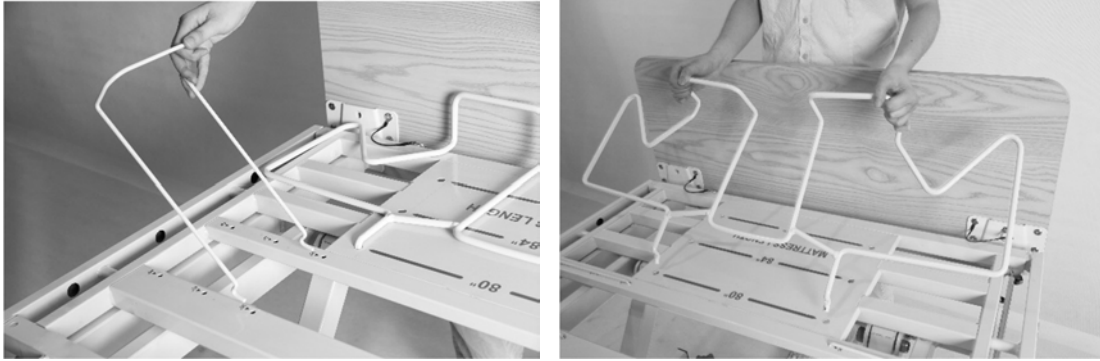

3. Insert the bed end mattress retainer in the foot side of the bed deck through the precast holes.
4. Ensure that all mattress retainers are flat against the bed deck.

Certain bed models have multiple sets of holes for various bed widths and lengths. Adjust the mounting position accordingly for different sized mattresses. The mounting holes are labeled with the corresponding size. Ensure the mattress fits snugly within the mattress retainers.

Installing the Wall Bumper Bar

1. Clip the wall bumper bar assembly into the caster support shaft at the head end of the bed. Ensure the bumper bar foot stand is facing the floor.

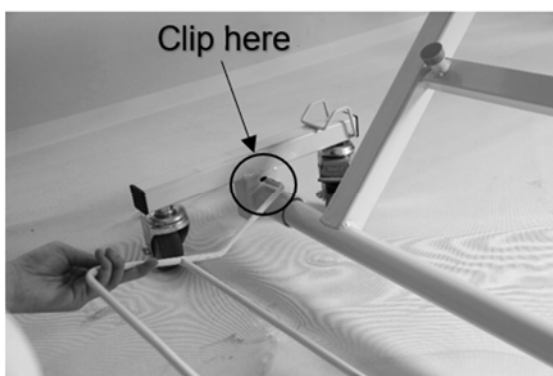

Installing the Rails or Assist Bars

1. Before installing the rails or bars, the bed should be in a flat position.
2. Loosen the screws, unclip the metal snap ring and remove the metal pins from the U-shaped insert of the rail or assist bar.
3. Remove cover for the appropriate holes.



4. Slide the U-shaped insert into the assist bar bracket.
5. Place the rail bracket onto the edge of the bed decking. Align the rail bracket mounting holes with the bed deck mounting holes. Secure them with a bolt and nut.
6. The rails are side specific. Place right and left rails on respective sides according to the labeling.

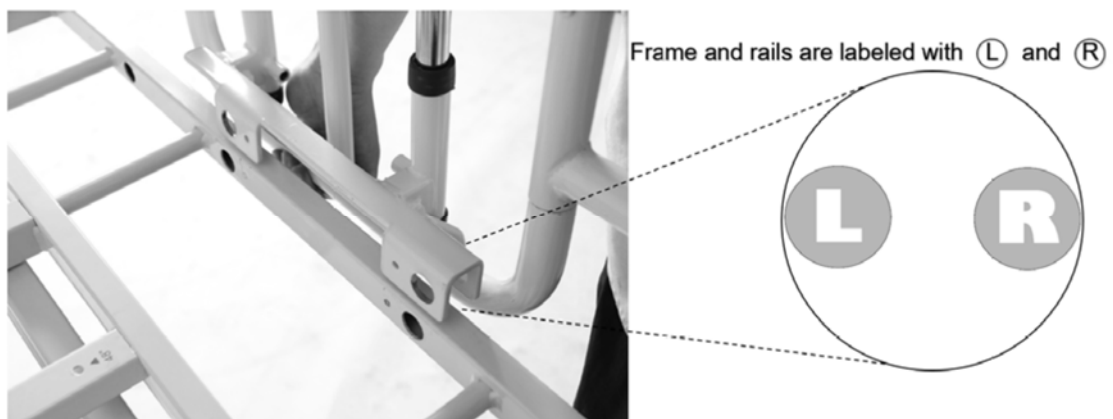
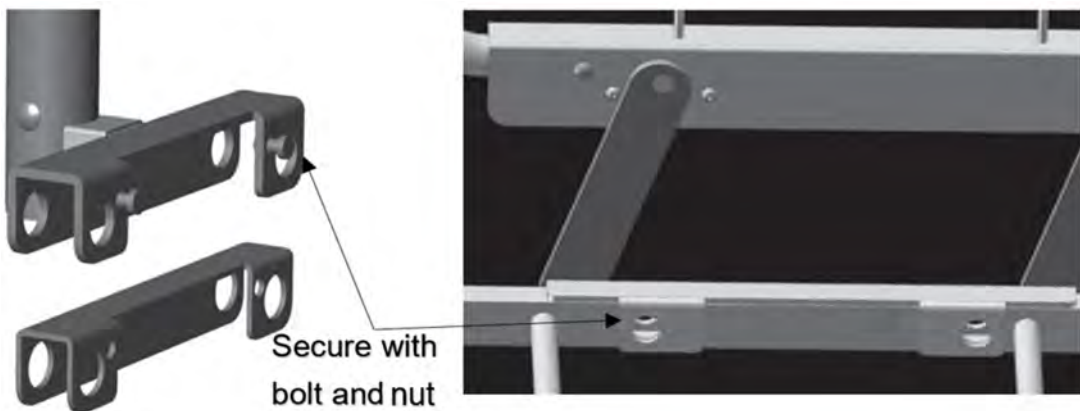

7. Re-insert the metal pins from the outside edge of the bed through the mounting holes and secure with snap rings on the inside edge of the bed. Make sure the snap rings are positioned in the groove of the metal pins.

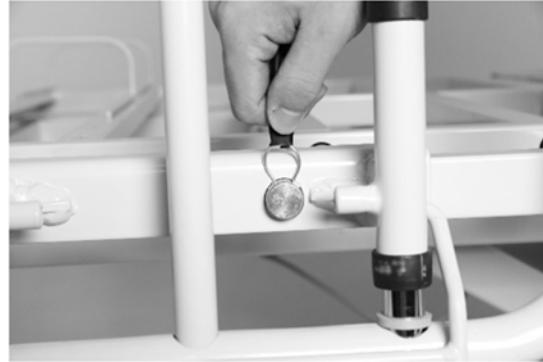

8. Repeat the same procedures to install the other rails.

Connecting the Control Box

Upon opening the control box, each motor connection port is color coded for ease of identification.



1. DC Port
2. Back Motor (Green)
3. Foot Motor (Red)
4. Hi-Lo Motor (Yellow)
5. Hand Pendant
6. Battery Backup Port

Installing Battery Backup (Optional Accessory) (Item# BP-LTCSXB BB)

1. Switch the power supply off when installing the backup battery.
2. Affix the backup battery with nuts and bolts to the side of the control box, on the same holding plate.
3. Loosen the screw and open the control box by sliding the lid to expose the connection port.

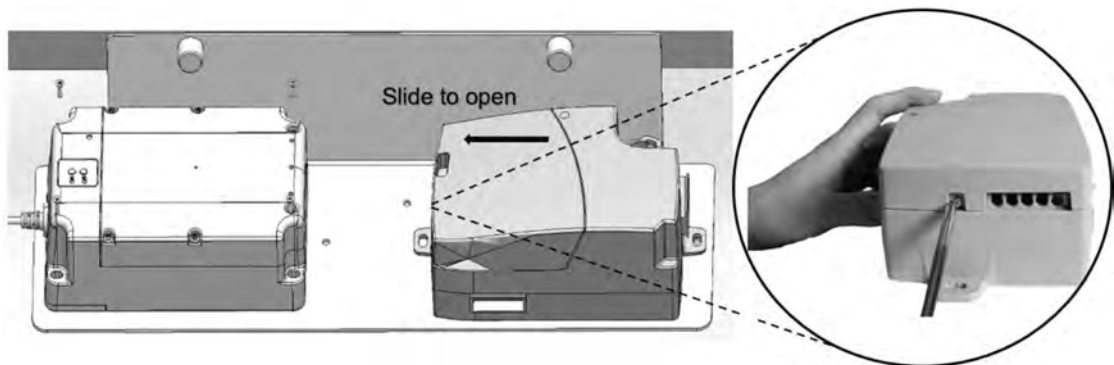

4. Connect the backup battery cord to the control box.
5. Close the lid, fasten the screw and switch the power supply back on.

Equipment Operation

Positioning the Bed

1. To lock the bed, step on the lever at the front and rear casters.



2. The caster guides on both sides of the head end casters should be lowered to prevent sideways movements. When lowered, the caster guide should hug around the caster.



3. To unlock the casters, step on the "Off" lever at the rear of the bed. Lift up the caster guides on the head end casters to allow free movement.



CAUTION

Head end caster must be unlocked when raising and lowering the bed. Head end caster guide should be lowered onto the caster when bed is in use.

Extend the Length of the Bed from 80" to 84" or 88"

The bed length can be extended from 80" to two sizes.

To extend the bed length to 84":

1. Loosen the two black knobs located on the underside of the bed frame securing the footboard brackets. (Refer to page 11)
2. Pull the footboard brackets until reaching 84" distance mark on the brackets. Tighten the securing knobs once the brackets are extended.
3. Adjust the bed end mattress retention frame to the required position. The extension length is marked on the bed platform.

To extend the bed length to 88":

1. Loosen the two black knobs located on the underside of the bed frame securing the footboard brackets. (Refer to page 11)
2. Pull the footboard brackets until reaching 88" distance mark on the brackets. Tighten the securing knobs once the brackets are extended.
3. Adjust the bed end mattress retention frame to the required position. The extension length is marked on the bed platform.

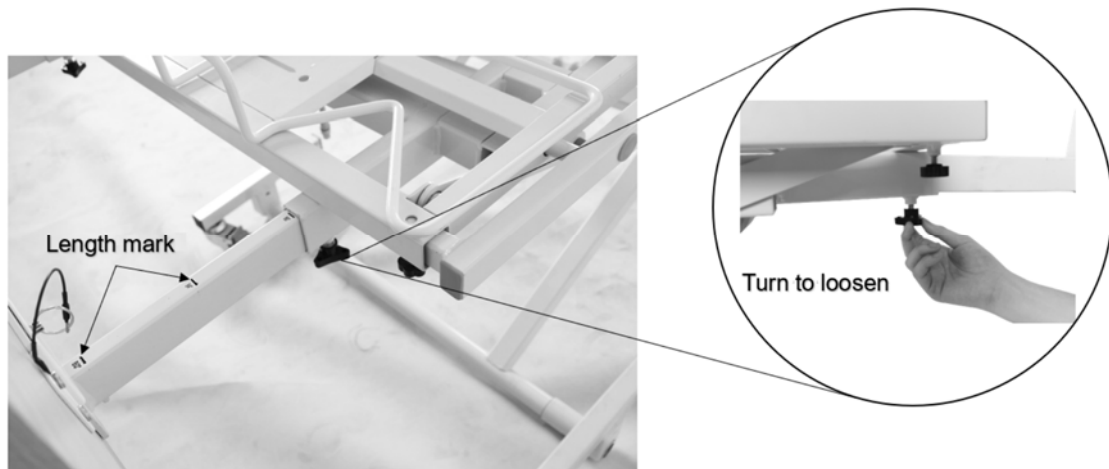

Using the Hand Pendant

The up arrow (▲) indicates raising the corresponding parts of the bed.

The down arrow (▼) indicates lowering the corresponding parts of the bed.



1. Use button 1 and 2 to adjust the backrest up or down.
2. Use button 3 and 4 to adjust the knee-break up or down.
3. Use button 5 and 6 to adjust the backrest and knee-break up or down.
4. Use button 7 and 8 to simultaneously raise or lower the bed platform.

Operating the Bedrails (Optional Accessory)



Installation refers to page 13 and 14.

Quarter Side Rail (Item# PMLTCQRAIL)

- ◆ Raise bed rail: Pull the bed rail upwards; the rail clasp will automatically clip to the bottom edge and there should be an audible click indicating the rail is locked in place.
- ◆ Lower bed rail: While holding onto the top part of the rail, remove the clasp from bottom of rail & "gently" lower the rail to its desired position.

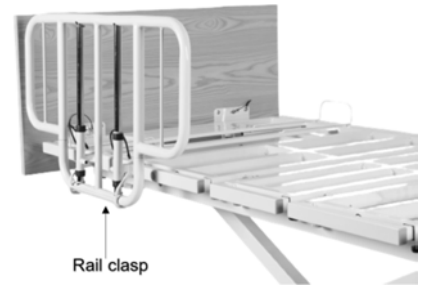

Soft Touch Swing Rail (Item# PMLTCSRIL)

- ◆ Raise bed rail: Pull the bed rail upwards until the rail is securely locked in place.
- ◆ Lower bed rail: Press the release button, slowly lower the rail to its lowest position.



Qbar Assist Bar (Item# PMLTCQBAR)

- ◆ Parallel or perpendicular Alignment: Lift up and rotate the bar until it is parallel or perpendicular to the bed edge. Lower the bar and ensure it is securely locked in place.

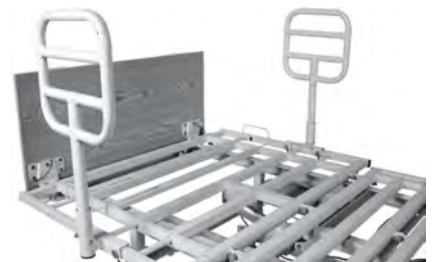

Pivot Assist Bar (Item# PMLTCPRAIL)

- ◆ Raise assist bar: Pull the bar upwards until it is securely locked in place. Ensure the release button is engaged.
- ◆ Lower assist bar: Pull the release knob and slowly lower the bar to its lowest position.

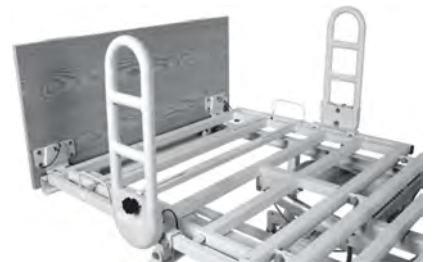

Trouble Shooting Guide

Symptoms	Possible Faults	Possible Solutions
Bed idle when hand pendant buttons are pressed.	<p>Adjustment may be at the maximum or minimum position.</p> <p>Power cord not connected or damaged.</p> <p>Hand pendant or actuator connectors are loose.</p> <p>Control box, hand pendant or actuator are broken.</p> <p>Load is too heavy.</p>	<p>Check if other buttons are working.</p> <p>Ensure the power cord is properly connected to the electrical socket and the bed.</p> <p>Ensure tight connection of all connectors to control box.</p> <p>Replace the control box, hand pendant or actuator. Contact your supplier.</p> <p>Ensure the load weight is within the designated capacity. Reduce the load.</p>
Casters/Brakes noisy or stiff.	Debris or fluff in bearings.	Replace casters.
Noisy or dry sound from pivots.	Needs lubrication.	Lubricate your bed.
Unusual noise from actuator.	Actuator is worn or damaged or spindle is bent.	Replace the actuator. Contact your supplier.
Head/footboard unstable.	Head/footboard frame not tightly secured.	Refer to Equipment Assembly.

If problems persist following the above remedial procedures, please contact your dealer or the manufacturer.

Limited Warranty

Your Proactive Medical brand product is warranted as follows:

Frames: 15 years

Electronic components: 5 years

Hand pendant: 1 year

This warranty does not cover device failure due to owner misuse or negligence or normal wear and tear. The warranty does not extend to nondurable components, such as rubber accessories, casters and etc. which are subject to normal wear and need periodic replacement.

If you have a question about your Proactive Medical device or this warranty; please contact an authorized Proactive Medical dealer.

Appendix
Service record

Date	Performed by	Condition Report



270 Washington Street
Mount Vernon, NY 10553
855-237-7622
www.proactivemedical.com