

RAZOR BLADE JR

ORDER FORM 2022

Tel: 951-808-9131 FAX: 951-808-9949
Toll Free: 800-892-8998 www.colourswheelchair.com

Ver.10.1

DEALER		COLOURS INFORMATION For Office Use Only	
Dealer:		Order Date:	S/N:
Account:	P.O.#:		
Ordered By:			
Customer Name:			
Customer Weight:			
CHAIR INFORMATION		MSRP PRICING	
RAZOR BLADE JR HCPC E1235		Base Wheel Chair Price E1235 \$ 2,832	
Fixed Seat Bucket		Total Section A \$	
Max. Capacity 250lbs		Total Section B \$	
NOTE: Growth kit option on Width and Depth		Total Section C(Custom Parts Color) \$	
Main Frame : ZK55 & ZK60 High Grade A7000 Series Aluminum		Total Section D \$	
Main Frame : Lifetime Warranty(5 YEARS)		Total Section E \$	
*See warranty policy		Total Section F \$	
		Total Section G \$	
		Total Section H \$	
		ORDER GRAND TOTAL \$	

FRAME COLORS & PARTS COLORS

FRAME COLORS		
Powder-Co	<input type="checkbox"/> Gloss Black <input type="checkbox"/> Twilight Flake <input type="checkbox"/> Yellow <input type="checkbox"/> Magenta <input type="checkbox"/> Fire Engine Red <input type="checkbox"/> White <input type="checkbox"/> Neon Yellow <input type="checkbox"/> Candy Blue <input type="checkbox"/> Candy Purple <input type="checkbox"/> Candy Green <input type="checkbox"/> Candy Red <input type="checkbox"/> Candy Raspberry <input type="checkbox"/> Cobalt Blue <input type="checkbox"/> Brass Metallic <input type="checkbox"/> Matte Gray <input type="checkbox"/> Matte Purple <input type="checkbox"/> Matte Blue <input type="checkbox"/> Matte Green <input type="checkbox"/> Matte Black <input type="checkbox"/> Matte Red <input type="checkbox"/> Tiffany Blue <input type="checkbox"/> Neon Red <input type="checkbox"/> Neon Green <input type="checkbox"/> Orange Sparkle <input type="checkbox"/> Mellon Yellow <input type="checkbox"/> Gun Smoke Silver <input type="checkbox"/> Shocker Yellow <input type="checkbox"/> Sparkle Burgundy <input type="checkbox"/> Granny Sparkle Green <input type="checkbox"/> Sparkle Sky Blue <input type="checkbox"/> Reed Green <input type="checkbox"/> Blue Lilac	STD
Special	<input type="checkbox"/> Polished <input type="checkbox"/> 24 karat Gold Plated	\$ 920 \$ CFP
PARTS COLORS (Custom Parts Color Section, Please see Section C)		
STD Color	Black Color (*Suspension Springs-Silver Color Only)-	\$ STD
Custom Color Main Bolt on Parts One Color Package	Including: Backrest, Foot Plate, Footrest Rings, Backrest Brackets , Saddle Stops, Forks & Knurl Nuts, Caps, Front Suspension Springs, Axle Tube, Axle Clamps, Axle Plates, Axle Bases, Camber Discs ☆marked parts	<input type="checkbox"/> Powder-Coated ()... \$ 575 <input type="checkbox"/> Polished \$ 863 <input type="checkbox"/> 24 karat Gold Plated \$ CFP

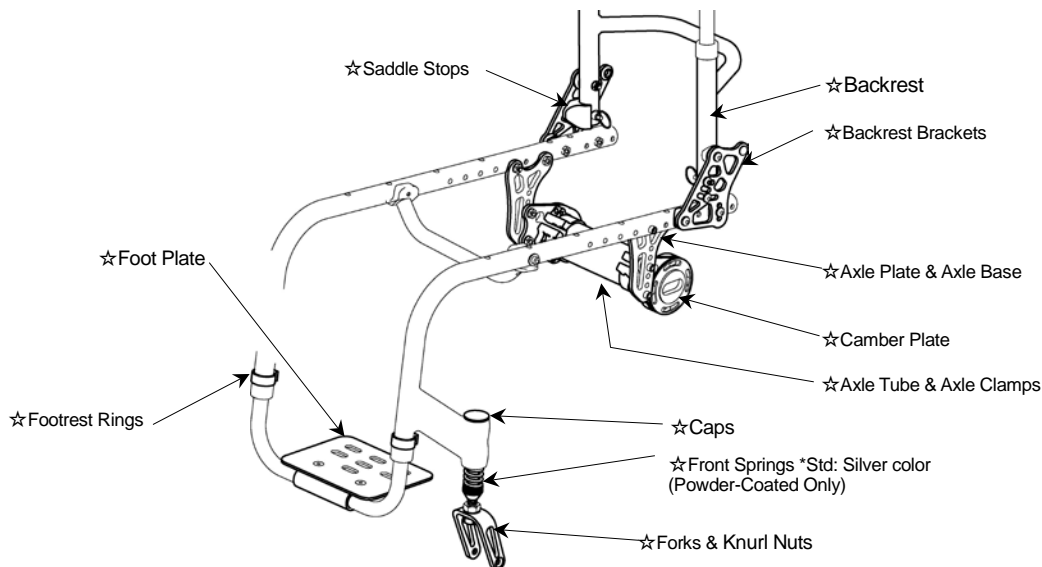

B FRAME MEASUREMENTS 1/2

*DETAILED MEASURING GUIDE IN
BACK OF ORDER
FORM

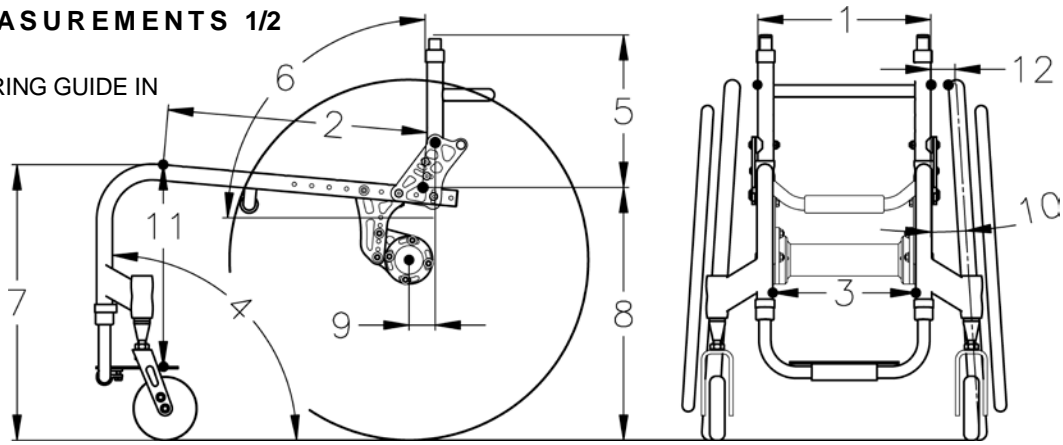

1. SEAT WIDTH	<input type="checkbox"/> 10" <input type="checkbox"/> 11" <input type="checkbox"/> 12" <input type="checkbox"/> 13" <input type="checkbox"/> 14" <input type="checkbox"/> 15" <input type="checkbox"/> 16"	\$ STD								
2. SEAT DEPTH * Only Choose One Option	<input type="checkbox"/> Net Seat Depth <input type="checkbox"/> 9" <input type="checkbox"/> 10" <input type="checkbox"/> 11" <input type="checkbox"/> 12" <input type="checkbox"/> 13" <input type="checkbox"/> 14" <input type="checkbox"/> 15" <input type="checkbox"/> 16" ...	\$ STD								
	<input type="checkbox"/> Depth Adj. Frame <input type="checkbox"/> Short Frame (13" Depth) Set at <input type="checkbox"/> 9" <input type="checkbox"/> 10" <input type="checkbox"/> 11" <input type="checkbox"/> 12" <input type="checkbox"/> 13"	\$ STD								
	<input type="checkbox"/> STD Frame (16" Depth) Set at <input type="checkbox"/> 12" <input type="checkbox"/> 13" <input type="checkbox"/> 14" <input type="checkbox"/> 15" <input type="checkbox"/> 16"	\$ STD								
	<input type="checkbox"/> Positioning Frame Add (")	\$ 173								
	<input type="checkbox"/> Ergo Seat Tubing Depth (") *STD 5" *Measurement must be 4" longer than your Center of Gravity	\$ 230								
3. FOOTREST WIDTH	<input type="checkbox"/> STD (Seat Width Minus 2", No Taper Frame) <input type="checkbox"/> Custom (") *Taper on Top or Reverse Taper on Bottom Only	\$ STD \$ NCO								
FOOT PLATE STYLE	<input type="checkbox"/> Standard single loop with adjust. height & angle. STD Foot Plate K0040 <input type="checkbox"/> Single Flip-Back-single loop (no riser avail) with adjust. height & angle. STD Foot Plate K0040	\$ STD \$ 173								
<input type="checkbox"/> Add Anti-Skid Tape (\$20 up charge)	STD Foot Plate Size Chart <table border="1"> <thead> <tr> <th>Your Footrest Width</th> <th>Foot Plate Size</th> </tr> </thead> <tbody> <tr> <td>8.0"-10.5"</td> <td>W6.5"xD5"</td> </tr> <tr> <td>11.0"-13.0"</td> <td>W8.5"xD6.5"</td> </tr> <tr> <td>13.5"-17.0"</td> <td>W11"xD6.5"</td> </tr> </tbody> </table>	Your Footrest Width	Foot Plate Size	8.0"-10.5"	W6.5"xD5"	11.0"-13.0"	W8.5"xD6.5"	13.5"-17.0"	W11"xD6.5"	
Your Footrest Width	Foot Plate Size									
8.0"-10.5"	W6.5"xD5"									
11.0"-13.0"	W8.5"xD6.5"									
13.5"-17.0"	W11"xD6.5"									
CUSTOM FOOT PLATE	<input type="checkbox"/> Custom Foot Plate with adjust. height & angle K0040 *Available Solid Plate Only <input type="checkbox"/> Drill 2Sets Extra Holes in Footplate (") *Measurement must be 2.5" shorter than your Footrest Width <input type="checkbox"/> Custom Tubular Footrest <input type="checkbox"/> With ABS Foot Plate (\$75 up charge)	\$ 100 \$ 288								
4. FRAME ANGLE	<input type="checkbox"/> 75° <input type="checkbox"/> 80° <input type="checkbox"/> 85° <input type="checkbox"/> 90° To the ground <input type="checkbox"/> Custom (°) to the ground	\$ STD \$ NCO								

B FRAME MEASUREMENTS 2/2

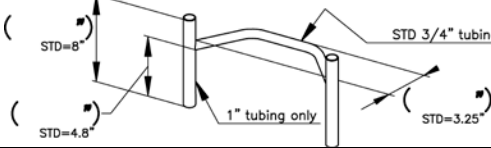
5. BACKREST HEIGHT * Rigidizer bar 3.25" deep std.			Adj. Range <input type="checkbox"/> 8" <input type="checkbox"/> 9" <input type="checkbox"/> 10" <input type="checkbox"/> 11" <input type="checkbox"/> 12" <input type="checkbox"/> 13" <input type="checkbox"/> 14" <input type="checkbox"/> 15" <input type="checkbox"/> 16" <input type="checkbox"/> 17" <input type="checkbox"/> 18"			\$ STD																																																																																																																
TYPE		<input type="checkbox"/> Locking mechanism with adjust. height & angle				\$ STD																																																																																																																
		<input type="checkbox"/> Double Locking mechanism with adjust. height & angle				\$ 29																																																																																																																
		<input type="checkbox"/> Folding with adjust. height & angle				\$ NCO																																																																																																																
CUSTOM		<input type="checkbox"/> Welded Backrest Angle Set at () to the ground *Non Folding Backrest only				\$ 173																																																																																																																
		<input type="checkbox"/> Welded Side Guards *Non Folding Backrest only				\$ 518																																																																																																																
																																																																																																																						
		<input type="checkbox"/> Custom Backrest				\$ 173																																																																																																																
		(ie: double rigidizer bars, custom depth, custom height, etc)																																																																																																																				
																																																																																																																						
6. BACKREST ANGLE			Set at () ° to the ground *STD 90°			\$ STD																																																																																																																
7. FRONT SEAT HEIGHT			<input type="checkbox"/> 14.5" <input type="checkbox"/> 15.0" <input type="checkbox"/> 15.5" <input type="checkbox"/> 16.0" <input type="checkbox"/> 16.5" <input type="checkbox"/> 17.0" <input type="checkbox"/> 17.5" <input type="checkbox"/> 18.0" <input type="checkbox"/> 18.5" <input type="checkbox"/> 19.0"			\$ STD																																																																																																																
STD Front Seat Height Ranges <table border="1" data-bbox="535 777 1006 892"> <tr><th>Caster Wheel Size</th><th>Front Seat Height</th></tr> <tr><td>3" Caster</td><td>14.5"- 17.5"</td></tr> <tr><td>4" Caster</td><td>15.0"- 18.0"</td></tr> <tr><td>5" Caster</td><td>15.5"- 19.0"</td></tr> </table>			Caster Wheel Size	Front Seat Height	3" Caster	14.5"- 17.5"	4" Caster	15.0"- 18.0"	5" Caster	15.5"- 19.0"																																																																																																												
Caster Wheel Size	Front Seat Height																																																																																																																					
3" Caster	14.5"- 17.5"																																																																																																																					
4" Caster	15.0"- 18.0"																																																																																																																					
5" Caster	15.5"- 19.0"																																																																																																																					
<input type="checkbox"/> CUSTOM FRONT SEAT HEIGHT ()			\$ NCO																																																																																																																			
8. REAR SEAT HEIGHT			<input type="checkbox"/> 12.5" <input type="checkbox"/> 13.0" <input type="checkbox"/> 13.5" <input type="checkbox"/> 14.0" <input type="checkbox"/> 14.5" <input type="checkbox"/> 15.0" <input type="checkbox"/> 15.5" <input type="checkbox"/> 16.0" <input type="checkbox"/> 16.5" <input type="checkbox"/> 17.0" <input type="checkbox"/> 17.5"			\$ STD																																																																																																																
Rear Seat Height Ranges *No Custom Modifications			<table border="1" data-bbox="535 976 1006 1123"> <tr><th>Rear Tire Size</th><th>Rear Seat Height</th></tr> <tr><td>20"x1"(451)</td><td>12.5"- 16.0"</td></tr> <tr><td>20"x1 3/8"(451)</td><td>13.0"- 16.5"</td></tr> <tr><td>22"x1"(501)</td><td>13.5"- 17.0"</td></tr> <tr><td>22"x1 3/8"(501)</td><td>14.0"- 17.5"</td></tr> </table>			Rear Tire Size	Rear Seat Height	20"x1"(451)	12.5"- 16.0"	20"x1 3/8"(451)	13.0"- 16.5"	22"x1"(501)	13.5"- 17.0"	22"x1 3/8"(501)	14.0"- 17.5"																																																																																																							
Rear Tire Size	Rear Seat Height																																																																																																																					
20"x1"(451)	12.5"- 16.0"																																																																																																																					
20"x1 3/8"(451)	13.0"- 16.5"																																																																																																																					
22"x1"(501)	13.5"- 17.0"																																																																																																																					
22"x1 3/8"(501)	14.0"- 17.5"																																																																																																																					
9. CENTER OF GRAVITY			<input type="checkbox"/> 0.0" <input type="checkbox"/> 0.5" <input type="checkbox"/> 1.0" <input type="checkbox"/> 1.5" <input type="checkbox"/> 2.0" <input type="checkbox"/> 2.5" <input type="checkbox"/> 3.0" <input type="checkbox"/> 3.5" <input type="checkbox"/> 4.0" <input type="checkbox"/> 4.5".....			\$ STD																																																																																																																
Center of Gravity Ranges		<table border="1" data-bbox="422 1165 1291 1438"> <tr><th colspan="2"></th><th colspan="8">Your Center of Gravity</th></tr> <tr><th colspan="2"></th><th>0"</th><th>0.5"</th><th>1"</th><th>1.5"</th><th>2"</th><th>2.5"</th><th>3"</th><th>3.5"</th><th>4"</th><th>4.5"</th></tr> <tr><th rowspan="7">Your Seat Depth</th><th>9"</th><td><input type="checkbox"/>☆☆</td><td><input type="checkbox"/>☆☆</td><td></td><td></td><td></td><td></td><td></td><td></td><td></td><td></td></tr> <tr><th>10"</th><td><input type="checkbox"/></td><td><input type="checkbox"/>☆☆</td><td></td><td></td><td></td><td></td><td></td><td></td><td></td><td></td></tr> <tr><th>11"</th><td><input type="checkbox"/></td><td><input type="checkbox"/>☆</td><td><input type="checkbox"/>☆</td><td><input type="checkbox"/>☆☆</td><td></td><td></td><td></td><td></td><td></td><td></td></tr> <tr><th>12"</th><td><input type="checkbox"/></td><td><input type="checkbox"/></td><td><input type="checkbox"/></td><td><input type="checkbox"/>☆</td><td><input type="checkbox"/>☆☆</td><td></td><td></td><td></td><td></td><td></td></tr> <tr><th>13"</th><td><input type="checkbox"/></td><td><input type="checkbox"/></td><td><input type="checkbox"/></td><td><input type="checkbox"/></td><td><input type="checkbox"/></td><td><input type="checkbox"/>☆</td><td><input type="checkbox"/>☆☆</td><td></td><td></td><td></td></tr> <tr><th>14"</th><td><input type="checkbox"/></td><td><input type="checkbox"/></td><td><input type="checkbox"/></td><td><input type="checkbox"/></td><td><input type="checkbox"/></td><td><input type="checkbox"/></td><td><input type="checkbox"/></td><td><input type="checkbox"/>☆☆</td><td></td><td></td></tr> <tr><th>15"</th><td><input type="checkbox"/></td><td><input type="checkbox"/></td><td><input type="checkbox"/></td><td><input type="checkbox"/></td><td><input type="checkbox"/></td><td><input type="checkbox"/></td><td><input type="checkbox"/></td><td><input type="checkbox"/></td><td><input type="checkbox"/>☆</td><td><input type="checkbox"/>☆☆</td></tr> <tr><th>16"</th><td><input type="checkbox"/></td><td><input type="checkbox"/></td><td><input type="checkbox"/></td><td><input type="checkbox"/></td><td><input type="checkbox"/></td><td><input type="checkbox"/></td><td><input type="checkbox"/></td><td><input type="checkbox"/></td><td><input type="checkbox"/></td><td><input type="checkbox"/></td></tr> </table>							Your Center of Gravity										0"	0.5"	1"	1.5"	2"	2.5"	3"	3.5"	4"	4.5"	Your Seat Depth	9"	<input type="checkbox"/> ☆☆	<input type="checkbox"/> ☆☆									10"	<input type="checkbox"/>	<input type="checkbox"/> ☆☆									11"	<input type="checkbox"/>	<input type="checkbox"/> ☆	<input type="checkbox"/> ☆	<input type="checkbox"/> ☆☆							12"	<input type="checkbox"/>	<input type="checkbox"/>	<input type="checkbox"/>	<input type="checkbox"/> ☆	<input type="checkbox"/> ☆☆						13"	<input type="checkbox"/>	<input type="checkbox"/>	<input type="checkbox"/>	<input type="checkbox"/>	<input type="checkbox"/>	<input type="checkbox"/> ☆	<input type="checkbox"/> ☆☆				14"	<input type="checkbox"/>	<input type="checkbox"/>	<input type="checkbox"/>	<input type="checkbox"/>	<input type="checkbox"/>	<input type="checkbox"/>	<input type="checkbox"/>	<input type="checkbox"/> ☆☆			15"	<input type="checkbox"/>	<input type="checkbox"/>	<input type="checkbox"/>	<input type="checkbox"/>	<input type="checkbox"/>	<input type="checkbox"/>	<input type="checkbox"/>	<input type="checkbox"/>	<input type="checkbox"/> ☆	<input type="checkbox"/> ☆☆	16"	<input type="checkbox"/>	<input type="checkbox"/>	<input type="checkbox"/>	<input type="checkbox"/>	<input type="checkbox"/>	<input type="checkbox"/>	<input type="checkbox"/>	<input type="checkbox"/>	<input type="checkbox"/>	<input type="checkbox"/>	
		Your Center of Gravity																																																																																																																				
		0"	0.5"	1"	1.5"	2"	2.5"	3"	3.5"	4"	4.5"																																																																																																											
Your Seat Depth	9"	<input type="checkbox"/> ☆☆	<input type="checkbox"/> ☆☆																																																																																																																			
	10"	<input type="checkbox"/>	<input type="checkbox"/> ☆☆																																																																																																																			
	11"	<input type="checkbox"/>	<input type="checkbox"/> ☆	<input type="checkbox"/> ☆	<input type="checkbox"/> ☆☆																																																																																																																	
	12"	<input type="checkbox"/>	<input type="checkbox"/>	<input type="checkbox"/>	<input type="checkbox"/> ☆	<input type="checkbox"/> ☆☆																																																																																																																
	13"	<input type="checkbox"/>	<input type="checkbox"/>	<input type="checkbox"/>	<input type="checkbox"/>	<input type="checkbox"/>	<input type="checkbox"/> ☆	<input type="checkbox"/> ☆☆																																																																																																														
	14"	<input type="checkbox"/>	<input type="checkbox"/>	<input type="checkbox"/>	<input type="checkbox"/>	<input type="checkbox"/>	<input type="checkbox"/>	<input type="checkbox"/>	<input type="checkbox"/> ☆☆																																																																																																													
	15"	<input type="checkbox"/>	<input type="checkbox"/>	<input type="checkbox"/>	<input type="checkbox"/>	<input type="checkbox"/>	<input type="checkbox"/>	<input type="checkbox"/>	<input type="checkbox"/>	<input type="checkbox"/> ☆	<input type="checkbox"/> ☆☆																																																																																																											
16"	<input type="checkbox"/>	<input type="checkbox"/>	<input type="checkbox"/>	<input type="checkbox"/>	<input type="checkbox"/>	<input type="checkbox"/>	<input type="checkbox"/>	<input type="checkbox"/>	<input type="checkbox"/>	<input type="checkbox"/>																																																																																																												
☆=Not Available 5" Caster. ★=Not Available 22" Wheel.																																																																																																																						
10. CAMBER ANGLE			<input type="checkbox"/> 2° <input type="checkbox"/> 4° <input type="checkbox"/> 6°			\$ STD																																																																																																																
11. FRONT OF SEAT SLING TO FOOTREST			<input type="checkbox"/> 12.5" <input type="checkbox"/> 13.0" <input type="checkbox"/> 13.5" <input type="checkbox"/> 14.0" <input type="checkbox"/> 14.5" <input type="checkbox"/> 15.0" <input type="checkbox"/> 15.5" <input type="checkbox"/> 16.0" <input type="checkbox"/> 16.5" <input type="checkbox"/> 17.0" <input type="checkbox"/> 17.5"			\$ STD																																																																																																																
			*Measurement must be 1.5" shorter than your Front Seat Height																																																																																																																			
HIGH MOUNT With Risers or Clamps			<input type="checkbox"/> 7.0" <input type="checkbox"/> 7.5" <input type="checkbox"/> 8.0" <input type="checkbox"/> 8.5" <input type="checkbox"/> 9.0" <input type="checkbox"/> 9.5" <input type="checkbox"/> 10.0" <input type="checkbox"/> 10.5" <input type="checkbox"/> 11.0" <input type="checkbox"/> 11.5" <input type="checkbox"/> 12.0".....			\$ 75																																																																																																																
12. INSIDE WHEEL CLEARANCE			<input type="checkbox"/> 3/4 <input type="checkbox"/> 1" <input type="checkbox"/> 1 1/4" <input type="checkbox"/> 1 1/2" <input type="checkbox"/> 1 3/4" <input type="checkbox"/> 2"			\$ STD																																																																																																																
			*3/4" Inside wheel clearance not available with 2 degree camber.																																																																																																																			
			*3/4" Inside wheel clearance not available with armrest.																																																																																																																			
NOTE Razorblade JR is a custom made wheelchair. If you would like to customize your Razor blade JR beyond what is available on this order form please submit your request here. Colours will determine as to whether this request can be accomplished while maintaining the safety and integrity of the wheelchair. If it can be accomplished the quote will reflect any and all custom charges, thank you.																																																																																																																						

1. SEAT WIDTH

Measure from outside of seat tube to the outside of the opposite seat tube.

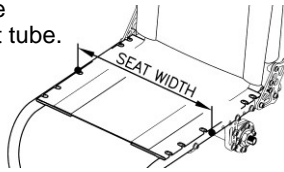

2. SEAT DEPTH

Measure from at the front bottom of backrest tube to the front edge of seat sling.

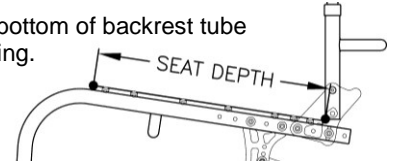

3. FOOTREST WIDTH

Measure from inside of front frame tube to inside of opposite front frame tube.

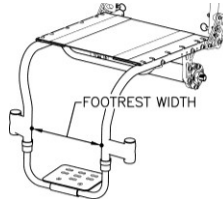

4. FRAME ANGLE

Measure angle frame front to floor.

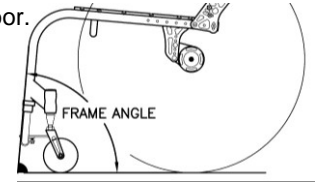

5. BACKREST HEIGHT

Measure from top of back post to seat sling at front bottom of backrest tube.

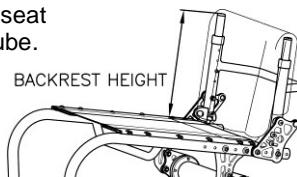

6. BACKREST ANGLE

Measure angle from front of back post to floor.

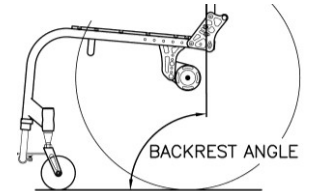

7. FRONT SEAT HEIGHT

Measure from floor to top of seat sling at front edge.

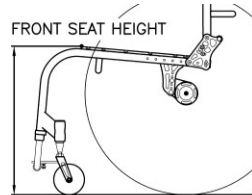

8. REAR SEAT HEIGHT

Measure from floor to top of seat sling at front bottom of backrest tube.

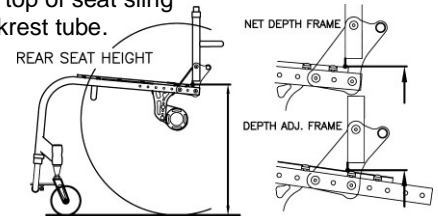

9. CENTER OF GRAVITY

Measure from center of back tube at the folding pivot to the center of the rear axle.

(If welding backrest is selected, Measure from center of back tube at the seat tube to the center of the rear axle.)

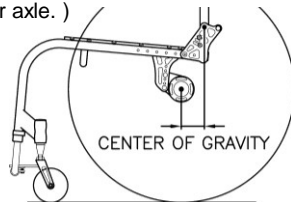

10. CAMBER ANGLE

Measure angle from wheel to vertical at floor.

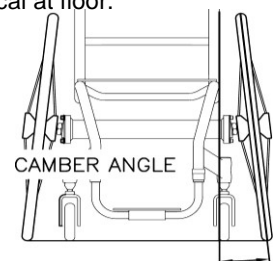

11. FRONT OF SEAT SLING TO FOOTREST

ADULT CHAIR

Measure from top of seat sling at front edge to top of foot plate at front edge.

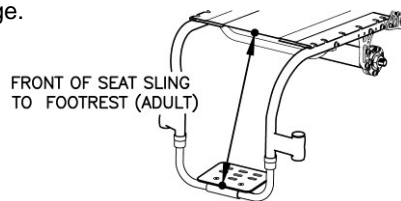

PEDIATRIC CHAIR

Measure vertical from top of seat sling at front edge to top of foot plate.

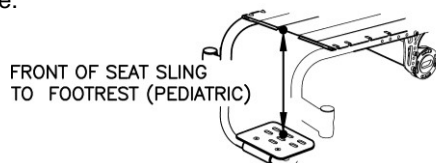

12. INSIDE WHEEL CLEARANCE

Measure from outside of seat back tube to inside of rear tire.

(If side guards are selected, measure from outside of side guards to inside of rear tire.)

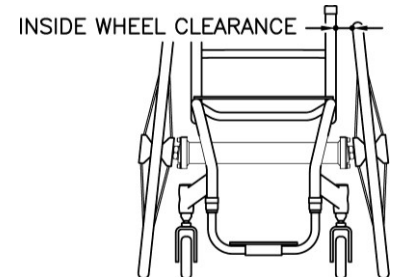

C SPECIAL PARTS COLORS (Please allow an additional 1-2 weeks delivery)

PARTS COLORS						
Powder-Coated	Gloss Black	Twilight Flake	Yellow	Magenta	Fire Engine Red	White
Neon Yellow	Candy Blue	Candy Purple	Candy Green	Candy Red	Candy Raspberry	Cobalt Blue
Brass Metallic	Matte Gray	Matte Purple	Matte Blue	Matte Green	Matte Black	Matte Red
Sparkle Burgundy	Neon Red	Neon Green	Orange Sparkle	Mellon Yellow	Gun Smoke Silver	Shocker Yellow
Tiffany Blue	Granny Sparkle Green	Sparkle Sky Blue	Reed Green	Blue Lilac		
Special Colors	Polished Aluminum					
	24 karat Gold Plated					

Please Choose the Color for each Part

*Parts not selected will be black color. (Suspension Spring: Silver Color)

*Minimum 3 parts selected per order.

*PC=Powder-Coated

Saddle Stops

- PC () \$46
- Polished..... \$132
- Gold Plated..... \$CFP

Backrest

- PC () \$144
- Polished..... \$259
- Gold Plated..... \$CFP

Backrest Brackets

- PC () \$104
- Polished..... \$132
- Gold Plated..... \$CFP

Foot Plate

- PC () \$52
- Polished..... \$104
- Gold Plated..... \$CFP

Footrest Rings

- PC () \$23
- Polished..... \$46
- Gold Plated..... \$CFP

Footrest Tubes

- PC..... N/A
- Polished..... \$98
- Gold Plated..... \$CFP

Foot Plate Clamps

- PC () \$58
- Polished..... \$86
- Gold Plated..... \$CFP

Caps

- PC () \$23
- Polished..... N/A
- Gold Plated..... N/A

Front Springs

- PC () \$23
- Polished..... N/A
- Gold Plated..... N/A

Forks & Knurl Nuts

- PC () \$75
- Polished..... \$104
- Gold Plated..... \$CFP

Axle Plates

- PC () \$75
- Polished..... \$98
- Gold Plated..... \$CFP

Camber Plates

- PC () \$58
- Polished..... \$86
- Gold Plated..... \$CFP

Axle Bases

- PC () \$58
- Polished..... \$86
- Gold Plated..... \$CFP

Axle Clamps

- PC () \$58
- Polished..... \$86
- Gold Plated..... \$CFP

Axle Tube

- PC () \$58
- Polished..... \$86
- Gold Plated..... \$CFP

D COMPONENTS

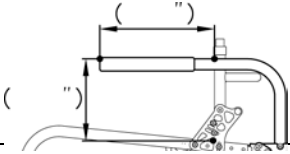
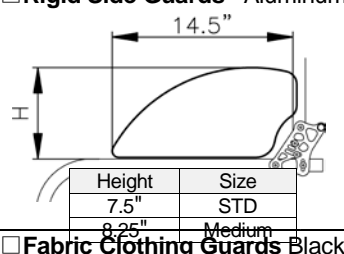
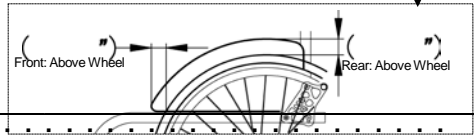
WHEEL LOCKS			
<input type="checkbox"/> New Solutions Push to Lock	<input type="checkbox"/> w/ 2" Extension Handle (\$80up charge)		\$ STD
<input type="checkbox"/> Gallop Push to Lock / Anodized			\$ STD
<input type="checkbox"/> Question Mark Style Scissor			\$ 70
<input type="checkbox"/> NEW Compact Scissor Lock / Anodized Black Only			\$ 127
<input type="checkbox"/> Gallop Scissor Lock / Anodized			\$ 127
PUSH HANDLES		*If you are ordering push handles, You must select the backrest locking mechanism.	
<input type="checkbox"/> Integrated w/Fixed Backrest Height / Anodized Black Only			\$ STD
<input type="checkbox"/> Bolt-on / Anodized Black Only	Specify Height from floor -()"		\$ 163
<input type="checkbox"/> Bolt-on w/Quick Release / Anodized Black Only	Specify Height from floor -()"		\$ 219
<input type="checkbox"/> NEW Height Adj. / Anodized Black Only	Specify Maximum height from floor -()"		\$ 339
NEW ARM RESTS		Anodized Black Only	
<input type="checkbox"/> Fixed Tubular Armrest	Adj. Angle and Height	Height from seat sling Set at : <input type="checkbox"/> 8" <input type="checkbox"/> 9" <input type="checkbox"/> 10" <input type="checkbox"/> 11" <input type="checkbox"/> 12" E0973	\$ 288
<input type="checkbox"/> Swing Away Tubular Armrest	Adj. Angle and Height	Height from seat sling Set at : <input type="checkbox"/> 8" <input type="checkbox"/> 9" <input type="checkbox"/> 10" <input type="checkbox"/> 11" <input type="checkbox"/> 12" E0973	\$ 288
<input type="checkbox"/> Flip-Up Armrest	<input type="checkbox"/> w/Fixed Tubular Armrest	Height from seat sling Set at : <input type="checkbox"/> 8" <input type="checkbox"/> 9" <input type="checkbox"/> 10" <input type="checkbox"/> 11" <input type="checkbox"/> 12" E0973	\$ 288
	Adj. Angle <input type="checkbox"/> w/ Swing Away Tubular Armrest	Height from seat sling Set at : <input type="checkbox"/> 8" <input type="checkbox"/> 9" <input type="checkbox"/> 10" <input type="checkbox"/> 11" <input type="checkbox"/> 12" E0973	\$ 288
<input type="checkbox"/> Custom Length & Height (\$150 up charge)			
*Specify Height & Length →			
ANTI-TIPPERS			
<input type="checkbox"/> Removable Anti-tipper(pair) Anodized Black Only		E0971	\$ 253
<input type="checkbox"/> Press Release Removable Anti-tipper(pair)		E0971	\$ 288
SIDE GUARDS			
<input type="checkbox"/> Rigid Side Guards - Black ABS	<input type="checkbox"/> Non-Removable <input type="checkbox"/> Removable <input type="checkbox"/> Removable w/Hole (\$12 up charge)		\$ 163
Color: Black Only	Size: <input type="checkbox"/> STD <input type="checkbox"/> Medium <input type="checkbox"/> Cut to Wheel (\$98 up charge)	Measurement	
<input type="checkbox"/> Rigid Side Guards - Aluminum	<input type="checkbox"/> Non-Removable <input type="checkbox"/> Removable		\$ 227
	Size: <input type="checkbox"/> Medium Only <input type="checkbox"/> Cut to Wheel (\$98 up charge)	Measurement	
	Color <input type="checkbox"/> Black (STD) <input type="checkbox"/> Pol. Aluminum (STD)		
	<input type="checkbox"/> Powder Coated () (\$120 up charge)		
	<input type="checkbox"/> Gold Plate (+CFP)		
			
<input type="checkbox"/> Fabric Clothing Guards Black Nylon w/Velcro			\$ 94
SEAT CUSHION		-*Please see section for other cushion choices.-	
<input type="checkbox"/> Foam Cushion	w/Nylon Black Cover Thickness <input type="checkbox"/> 1" <input type="checkbox"/> 2" <input type="checkbox"/> 3" <input type="checkbox"/> 4"		\$ CFP
<input type="checkbox"/> Custom Cushion Cover (Std. Foam Cushion Only)	Select Fabric () (\$90 up charge)		
ACCESSORIES			
<input type="checkbox"/> Frame Protectors / Black Leather/Zipper Type			\$ 94
<input type="checkbox"/> Gel Ovation Protector Wraps Gel Silicone			\$ 115
<input type="checkbox"/> E0978 Seat Belt w/Auto Buckle (BP) 1.5" Black Belt Only		E0978	\$ 98
<input type="checkbox"/> Tie Down Brackets 4pcs.			\$ 242
<input type="checkbox"/> Calf Strap <input type="checkbox"/> Black <input type="checkbox"/> Matching Fabric (\$55 up charge) -Select Fabric()			\$ 29
<input type="checkbox"/> Bodypoint Padded Calf Strap <input type="checkbox"/> (14"-16" footrest width) <input type="checkbox"/> (16"-20" footrest width) <input type="checkbox"/> (20"-24" footrest)	\$77 \$83 \$89		
<input type="checkbox"/> Hanging Zipper Pouch <input type="checkbox"/> Black <input type="checkbox"/> Matching Fabric (\$60) or <input type="checkbox"/> Leather (\$75) Custom Size Width: Length:			\$ 75
<input type="checkbox"/> Matching Fabric on Padded Side Guards -Select Fabric ()			\$ 242
UPHOLSTERY CHOICE & COLOR		*Positioning Back Available. Please see Section E	
<input type="checkbox"/> Standard Adjustable Height Backrest (Black)			\$ STD
<input type="checkbox"/> Adjustable Tension Backrest Black Only (*Not available with 8" Backrest Height)			\$ 150
Options	<input type="checkbox"/> Fun Fabric: For Std. or Adj. Style (Choose From Choices on Page 7 and write below) (\$ 80 up charge)		
	<input type="checkbox"/> Backrest Leather Trim (outside panels) (\$ up charge)		\$ CFP

FABRIC CHOICE SHEET

1. Camouflage Girls



2. Purple Zebra



3. Silver Grey Snake



5. Laughing Skulls



6. Purple Snake

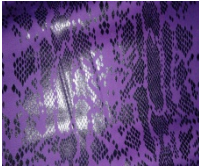

7. Sweetheart Pinup Girls



9. Blue Flames

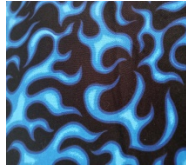

10. Arctic Camo



11. Furry Friends



12. Supercars



13. Urban Camo

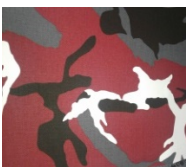

14. Superbikes



15. Sizzle Flames



16. Hot Rod Flames



17. Skulls w/ Attitude

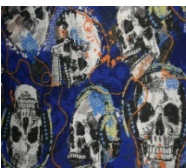

18. Sweet Pink



19. Heart and Soul



20. Home Run



21. Fuzzy Giraffe

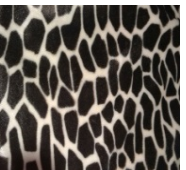

22. Cheetah



23. Paperweight Cobalt



24. Zig Zag Dots



25. Smokey Tribal Flames

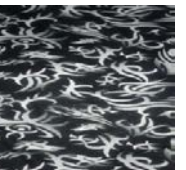

26. Rose and Rebellion



27. Tattoo Adventure(Cream

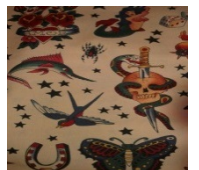

28. Red Tribal Flames

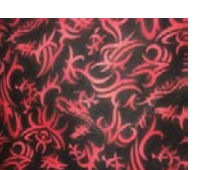

29. Tattoo Adventure(Black)

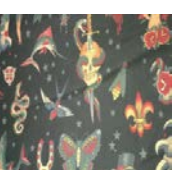

30. Butterfly Bandana

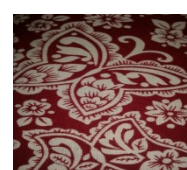

31. Tatsu Dragon

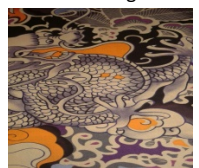



E TIRES, CASTERS, & FORKS

TIRES					
<input type="checkbox"/> Low Pressure Tire Only		<input type="checkbox"/> 20"x1-3/8" or <input type="checkbox"/> 22"x1-3/8" Gray E2211/E2212		\$ STD
<input type="checkbox"/> Primo High Pressure Tire Only		<input type="checkbox"/> 20 x 1(451) <input type="checkbox"/> 22"x1"(501) E2211/E2212		\$ NCO
<input type="checkbox"/> Solid Tire		<input type="checkbox"/> 20"x1" (451) <input type="checkbox"/> Dark Gray <input type="checkbox"/> 22 x 1 <input type="checkbox"/> Black Only(\$30) E2218		\$ 155
<input type="checkbox"/> E2213 Flat-Free Inserts		For 20"x1-3/8" or 22"x1-3/8" Tires Only E2211/E2213		\$ 135
<input type="checkbox"/> Schwalbe Marathon Plus High Pressure Tire		<input type="checkbox"/> 22 x 1			\$ 148
CASTERS					
SIZE	TIRE WIDTH	HUB COLOR	TIRE COLOR	DESCRIPTION	
<input type="checkbox"/> 3"	1"	Black Hub	Black Tire Only	Polyurethane	\$ STD
<input type="checkbox"/> 3"	1"	Plastic Black Hub	Clear Tire Only	Lighted, Polyurethane	\$ 75
<input type="checkbox"/> 3"	1"	Red Hub	Red Tire Only	Polyurethane	\$ STD
<input type="checkbox"/> 3"	1"	Black Hub	Clear Tire Only	Polyurethane	\$ STD
<input type="checkbox"/> 3"	1"	Aluminum Silver Hub	Black Tire Only	Made By Frog Legs	\$ 190
<input type="checkbox"/> 3"	1"	Aluminum Black Hub	Black Tire Only	Made By Frog Legs	\$ 190
<input type="checkbox"/> 3"	1.5"	Aluminum Silver Hub	Black Tire Only	Soft Roll Made By Frog Legs	\$ 190
<input type="checkbox"/> 3"	1.5"	Aluminum Black Hub	Black Tire Only	Soft Roll Made By Frog Legs	\$ 190
<input type="checkbox"/> 4"	1 1/8"	Plastic Black Hub	Black Tire Only	Polyurethane E2222	\$ STD
<input type="checkbox"/> 4"	1"	Plastic Black Hub	Clear Only	Lighted, Polyurethane	\$ 75
<input type="checkbox"/> 4"	1"	Aluminum Silver Hub	Black Tire Only	Made By Frog Legs	\$ 190
<input type="checkbox"/> 4"	1"	Aluminum Black Hub	Black Tire Only	Made By Frog Legs	\$ 190
<input type="checkbox"/> 4"	1.5"	Aluminum Silver Hub	Tire <input type="checkbox"/> Black <input type="checkbox"/> Blue <input type="checkbox"/> Red	Soft Roll Made By Frog Legs	\$ 190
<input type="checkbox"/> 4"	1.5"	Aluminum Black Hub	Black Tire Only	Soft Roll Made By Frog Legs	\$ 190
<input type="checkbox"/> 5"	1"	Composite Black Hub	Black Tire Only		\$ STD
<input type="checkbox"/> 5"	1"	Plastic Black Hub	Clear Tire Only	Lighted, Polyurethane	\$ 75
<input type="checkbox"/> 5"	1"	Aluminum Silver Hub	Black Tire Only	Made By Frog Legs	\$ 190
<input type="checkbox"/> 5"	1"	Aluminum Black Hub	Black Tire Only	Made By Frog Legs	\$ 190
<input type="checkbox"/> 5"	1.5"	Aluminum Silver Hub	Tire <input type="checkbox"/> Black <input type="checkbox"/> Blue <input type="checkbox"/> Red	Soft Roll Made By Frog Legs	\$ 190
<input type="checkbox"/> 5"	1.5"	Aluminum Black Hub	Black Tire Only	Soft Roll Made By Frog Legs	\$ 190
<input type="checkbox"/> "	<input type="checkbox"/> 1"OR <input type="checkbox"/> 1.5"	Hub Color:	Tread Color:	Soft Roll Made By Frog Legs	\$ CFP
FORKS					
<input type="checkbox"/> Frog Leg Shields(4 pcs) Only for FrogLeg Forks					\$ 28
<input type="checkbox"/> STD Aluminum Forks Black Only				\$ STD
Extra Options for Aluminum Forks		<input type="checkbox"/> With Suspension		E1015	\$ 63
		<input type="checkbox"/> With Quick Release Axles		K0073	\$ 123
<input type="checkbox"/> Frog Leg Suspension Forks Std 1" Wide (For 3", 4" x 1" width Caster and 5" lighted)		(Not available with Quick Release Axles			
User's	Color <input type="checkbox"/> Anodized Black <input type="checkbox"/> Anodized Silver Or STD 4" x 1 1/8" Casters)		E1015	\$ 552
<input type="checkbox"/> Frog Leg Suspension Forks 1.5" Wide (For 3", 4" x 1.5" width Caster and 5" Caster)		(Not available with Quick Release Axles)			
User's	Color <input type="checkbox"/> Anodized Black <input type="checkbox"/> Anodized Silver		E1015	\$ 552

Valid from 2022 Prices & Specifications Are Subject To Change Without Notice.

F WHEELS

WHEELS																		
Wire Wheels	<input type="checkbox"/> 20" (451) <input type="checkbox"/> 22" (501)		\$ STD															
Spinergy Spox 18 Spokes 	<input type="checkbox"/> 22" (501) <input type="checkbox"/> 22" (501) Spoke Color <input type="checkbox"/> Black <input type="checkbox"/> Red <input type="checkbox"/> Yellow <input type="checkbox"/> Blue <input type="checkbox"/> White <small>With Silver Hub With Black Hub With Black Hub With Black Hub With Black Hub</small>		\$ 907															
	<input type="checkbox"/> Custom Color Spoke Pattern <table border="1" style="display: inline-table; margin-left: 10px;"> <thead> <tr> <th colspan="2"></th> <th>Left Wheel</th> <th>Right Wheel</th> </tr> </thead> <tbody> <tr> <td rowspan="2">Spokes Color</td> <td>Inside</td> <td></td> <td></td> </tr> <tr> <td>Outside</td> <td></td> <td></td> </tr> <tr> <td colspan="2">Hub Color</td> <td><input type="checkbox"/> Black/<input type="checkbox"/> Silver</td> <td><input type="checkbox"/> Black/<input type="checkbox"/> Silver</td> </tr> </tbody> </table>			Left Wheel	Right Wheel	Spokes Color	Inside			Outside			Hub Color		<input type="checkbox"/> Black/ <input type="checkbox"/> Silver	<input type="checkbox"/> Black/ <input type="checkbox"/> Silver		\$ 1,007
			Left Wheel	Right Wheel														
Spokes Color	Inside																	
	Outside																	
Hub Color		<input type="checkbox"/> Black/ <input type="checkbox"/> Silver	<input type="checkbox"/> Black/ <input type="checkbox"/> Silver															
Spinergy LX 12 Spokes 	<input type="checkbox"/> 22" (501) Spoke Color <input type="checkbox"/> Black <input type="checkbox"/> Red <input type="checkbox"/> Yellow <input type="checkbox"/> Blue <small>With Silver Hub With Black Hub With Black Hub With Black Hub</small> <input type="checkbox"/> White <input type="checkbox"/> Neon Green <input type="checkbox"/> Pink <input type="checkbox"/> Orange <small>With Black Hub With Black Hub With Black Hub With Black Hub</small> <input type="checkbox"/> Purple With Black Hub		\$ 1,138															
	<input type="checkbox"/> Custom Color Spoke Pattern <table border="1" style="display: inline-table; margin-left: 10px;"> <thead> <tr> <th colspan="2"></th> <th>Left Wheel</th> <th>Right Wheel</th> </tr> </thead> <tbody> <tr> <td rowspan="2">Spokes Color</td> <td>Inside</td> <td></td> <td></td> </tr> <tr> <td>Outside</td> <td></td> <td></td> </tr> <tr> <td colspan="2">Hub Color</td> <td><input type="checkbox"/> Black/<input type="checkbox"/> Silver</td> <td><input type="checkbox"/> Black/<input type="checkbox"/> Silver</td> </tr> </tbody> </table>			Left Wheel	Right Wheel	Spokes Color	Inside			Outside			Hub Color		<input type="checkbox"/> Black/ <input type="checkbox"/> Silver	<input type="checkbox"/> Black/ <input type="checkbox"/> Silver		\$ 1,238
			Left Wheel	Right Wheel														
Spokes Color	Inside																	
	Outside																	
Hub Color		<input type="checkbox"/> Black/ <input type="checkbox"/> Silver	<input type="checkbox"/> Black/ <input type="checkbox"/> Silver															
HANDRIMS																		
Type	<input type="checkbox"/> Standard For 20" & 22" Wheel Anodized Silver		\$ STD															
	<input type="checkbox"/> Vinyl Coated For 20" & 22" Wheel		\$ 180															
	<input type="checkbox"/> Spinergy Silver Brushed Anodized For 24", 25" & 26" Wheels		\$ 160															
	<input type="checkbox"/> Natural Fit For 22" Wheel Only																	
	<input type="checkbox"/> Standard Grip (Not available with short tabs.)		\$ 495															
	<input type="checkbox"/> Super Grip (Not available with short tabs.)		\$ 561															
	<input type="checkbox"/> Without Thumb Grip		\$ 294															
	<input type="checkbox"/> Natural Fit (LT) For 22" Wheel Only																	
	<input type="checkbox"/> Standard Grip (Not available with short tabs.)		\$ 547															
	<input type="checkbox"/> Super Grip (Not available with short tabs.)		\$ 614															
<input type="checkbox"/> Without Thumb Grip		\$ 347																
<input type="checkbox"/> The Surge Handrims		\$ 481																
<input type="checkbox"/> The Surge Handrims (LT)		\$ 524																
<input type="checkbox"/> The Q-Grip Handrims : anti-slip, latex-free, neoprene coating. 22" Only		\$ 472																
<input type="checkbox"/> OMIT HANDRIMS		\$ NCO																
TAB LENGTH	<input type="checkbox"/> Long Tabs (STD inside clearance 3/4") *		\$ STD															
	<input type="checkbox"/> Short Tabs (Inside clearance 1/2")* Not available with Natural Fit Handrim with thumb grip		\$ STD															
	<input type="checkbox"/> Short Tab (Set closest to wheel cut off excess)		\$ 30															

G CHAIR OPTIONS 1/3

SEAT CUSHION					
SUPRACOR® WHEELCHAIR CUSHIONS					
Stimulite® Contoured Cushion *Black Upholstery only *Comes with Zipper Pouch <input type="checkbox"/> Extra Cover (\$104 up charge)	<input type="checkbox"/> W14"xD16" (CD1416)	E2603	\$ 615	
	<input type="checkbox"/> W16"xD16" (CD1616)	E2603	\$ 615	
		<input type="checkbox"/> Extra Sensitive (\$35 up charge) <input type="checkbox"/> Sling Style Bottom (\$452up) <input type="checkbox"/> Custom Size (\$ CFP) W(") x D(")			
Stimulite® Slimline Cushion *Black Upholstery only <input type="checkbox"/> Extra Cover (\$75 up charge) <input type="checkbox"/> Custom Size (\$ CFP)	<input type="checkbox"/> W14"xD16" (SM1416)	E2603	\$ 388	
	<input type="checkbox"/> W16"xD16" (SM1616)	E2603	\$ 388	
		<input type="checkbox"/> Extra Sensitive (\$35 up charge) <input type="checkbox"/> Sling Style Bottom (\$52 up charge)			
Stimulite® Corbee Pediatric Cushion *Black Upholstery only <input type="checkbox"/> Extra Cover (\$75 up charge)	<input type="checkbox"/> W10"xD10" (PD1010)	E2603	\$ 258	
	<input type="checkbox"/> W12"xD12" (PD1212)	E2603	\$ 258	
	<input type="checkbox"/> W14"xD14" (PD1414)	E2603	\$ 258	
		<input type="checkbox"/> Extra Sensitive (\$35 up charge) <input type="checkbox"/> Sling Style Bottom (\$52 up charge) <input type="checkbox"/> Custom Size W(") x D(") (\$CFP)			
ROHO WHEELCHAIR CUSHIONS					
Choose Size	<input type="checkbox"/> 4" HIGH PROFILE® QUADTRO SELECT® CUSHION *Black Upholstery		<input type="checkbox"/> Extra Cover (+\$57)	E2622-2623 \$ 582	
	<input type="checkbox"/> W12"xD12" <input type="checkbox"/> W12"xD13" <input type="checkbox"/> W13"xD13" <input type="checkbox"/> W13"xD15" <input type="checkbox"/> W13"xD16" <input type="checkbox"/> W15"xD13" <input type="checkbox"/> W15"xD15"	<input type="checkbox"/> W15"xD16" <input type="checkbox"/> W15"xD18" <input type="checkbox"/> W16"xD15"			
	<input type="checkbox"/> Custom Size W(") x D(") (\$CFP)				
Choose Size	<input type="checkbox"/> 3" MID PROFILE® QUADTRO SELECT® CUSHION *Black Upholstery only		<input type="checkbox"/> Extra Cover (+\$57)	E2622-2623 \$ 582	
	<input type="checkbox"/> W12"xD12" <input type="checkbox"/> W12"xD13" <input type="checkbox"/> W13"xD13" <input type="checkbox"/> W13"xD15" <input type="checkbox"/> W13"xD16" <input type="checkbox"/> W15"xD13"	<input type="checkbox"/> W15"xD15" <input type="checkbox"/> W15"xD16" <input type="checkbox"/> W15"xD18" <input type="checkbox"/> W16"xD15" <input type="checkbox"/> W16"xD16"			
	<input type="checkbox"/> Custom Size W(") x D(") (\$CFP)				
Choose Size	<input type="checkbox"/> 2" LOW PROFILE® QUADTRO SELECT® CUSHION *Black Upholstery only		<input type="checkbox"/> Extra Cover (+\$57)	E2622-2623 \$ 582	
	<input type="checkbox"/> W12"xD12" <input type="checkbox"/> W12"xD13" <input type="checkbox"/> W13"xD13" <input type="checkbox"/> W13"xD15" <input type="checkbox"/> W13"xD16" <input type="checkbox"/> W15"xD13" <input type="checkbox"/> W15"xD15"	<input type="checkbox"/> W15"xD16" <input type="checkbox"/> W15"xD18" <input type="checkbox"/> W16"xD15" <input type="checkbox"/> W16"xD16"			
	<input type="checkbox"/> Custom Size W(") x D(") (\$CFP)				
STAR CUSHIONS					
Galaxy Cushion *Black Upholstery only <input type="checkbox"/> W14"xD14" (GXY 1414-2) <input type="checkbox"/> W14"xD16" (GXY 1416-2) <input type="checkbox"/> W16"xD14" (GXY 1614-2) <input type="checkbox"/> W16"xD16" (GXY 1616-2)		⇒	Choose Zoning Options <input type="checkbox"/> Standard - Dual Valve <input type="checkbox"/> Dual Valve - Front to Back <input type="checkbox"/> Four Valve <input type="checkbox"/> Simple - Single Valve <input type="checkbox"/> Four Valve - Enhanced <input type="checkbox"/> Four Valve - Front to Back	E2624 \$ CFP	
THE CURVE CUSHION					
*Black Upholstery only <input type="checkbox"/> Extra Cover (+\$40)	<input type="checkbox"/> W10"xD10" <input type="checkbox"/> W10"xD11" <input type="checkbox"/> W10"xD11" <input type="checkbox"/> W10"xD12" <input type="checkbox"/> W11"xD12" <input type="checkbox"/> W12"xD12"	<input type="checkbox"/> W12"xD13" <input type="checkbox"/> W12"xD14" <input type="checkbox"/> W13"xD11" <input type="checkbox"/> W13"xD12" <input type="checkbox"/> W13"xD13" <input type="checkbox"/> W13"xD14"	<input type="checkbox"/> W14"xD14" <input type="checkbox"/> W14"xD15" <input type="checkbox"/> W14"xD16" <input type="checkbox"/> W15"xD14" <input type="checkbox"/> W15"xD15" <input type="checkbox"/> W15"xD16"	<input type="checkbox"/> W16"xD14" <input type="checkbox"/> W16"xD15" <input type="checkbox"/> W16"xD16"	\$ 127

G CHAIR OPTIONS 2/3

SEAT CUSHION			
Exgel Kaji Cushion			
For Comfortable Sitting To Prevent Pressure Sores			
<input type="checkbox"/> Owl Regular(1.6" Thick) Incontinence Cover Only	<input type="checkbox"/> W14"xD16"	E2603 \$ 362
	<input type="checkbox"/> W15"xD16"	E2603 \$ 362
	<input type="checkbox"/> W16"xD16"	E2603 \$ 362
	<input type="checkbox"/> W18"xD16" * No Custom Sizes	E2603 \$ 408
<input type="checkbox"/> Owl High(3.1" Thick) Incontinence Cover Only	<input type="checkbox"/> W14"xD16"	E2603 \$ 437
	<input type="checkbox"/> W15"xD16"	E2603 \$ 437
	<input type="checkbox"/> W16"xD16"	E2603 \$ 437
	<input type="checkbox"/> W18"xD16"	E2603 \$ 495
	<input type="checkbox"/> W18"xD18" * No Custom Sizes	E2603 \$ 495
<input type="checkbox"/> Owl Contour(4.3" Thick) Incontinence Cover Only	<input type="checkbox"/> W14"xD16"	E2603 \$ 454
	<input type="checkbox"/> W15"xD16"	E2603 \$ 454
	<input type="checkbox"/> W16"xD16"	E2603 \$ 454
	<input type="checkbox"/> W18"xD16"	E2603 \$ 495
* No Custom Sizes			
<input type="checkbox"/> Owl Deep Contour(4.3" Thick) <input type="checkbox"/> W14"xD16" \$ 458		* No Custom Sizes- Incontinence Cover Only	
<input type="checkbox"/> W14"xD16" \$518 <input type="checkbox"/> W15"xD16" \$518 <input type="checkbox"/> W16"xD16" \$518 <input type="checkbox"/> W18"xD16" \$558			
<input type="checkbox"/> Standard Regular(1.4" Thick) Easy to Use Flat Style (superior pressure redistribution)		<input type="checkbox"/> For Pressure Relief E2622-2623	
<input type="checkbox"/> W12" x D12" \$368 <input type="checkbox"/> W13" x D13" \$368 <input type="checkbox"/> W14" x D14" \$368 <input type="checkbox"/> W14" x D16" \$368 <input type="checkbox"/> W16" x D16" \$368 <input type="checkbox"/> W16" x D17" \$368 <input type="checkbox"/> W17" x D16" \$368 <input type="checkbox"/> W17" x D17" \$368 <input type="checkbox"/> W18" x D16" \$391 <input type="checkbox"/> W18" x D18" \$391 <input type="checkbox"/> W18" x D19" \$440 <input type="checkbox"/> W18" x D20" \$440 <input type="checkbox"/> W19" x D19" \$440			
* No Custom Sizes- Incontinence Cover Only			
<input type="checkbox"/> Standard High(2.6" Thick) Incontinence Cover Only	 E2622	
*Black Upholstery only			
<input type="checkbox"/> W12" x D12" \$383 <input type="checkbox"/> W13" x D13" \$ 383 <input type="checkbox"/> W14" x D14" \$383 <input type="checkbox"/> W14" x D16" \$ 383 <input type="checkbox"/> W16" x D16" \$383 <input type="checkbox"/> W16" x D17" \$383 <input type="checkbox"/> W17" x D16" \$383 <input type="checkbox"/> W17" x D17" \$383 <input type="checkbox"/> W18" x D16" \$460 <input type="checkbox"/> W18" x D18" \$460 <input type="checkbox"/> W18" x D19" \$512 <input type="checkbox"/> W18" x D20" \$512 <input type="checkbox"/> W19" x D19" \$512 <input type="checkbox"/> W18" x D19" \$512			
<input type="checkbox"/> Standard Anti-Thrust(2.6" Thick) * No Custom Sizes Incontinence Cover Only		<input type="checkbox"/> W16 x D16 \$460 Prevents Unwanted <input type="checkbox"/> W18 x D16 \$500 Forward Movement of <input type="checkbox"/> W18 x D18 \$500 lower back and hip bone	
<input type="checkbox"/> Lite Regular(2.2" Thick)		<input type="checkbox"/> W16" x D16" \$374 <input type="checkbox"/> W18" x D16" \$397 <input type="checkbox"/> W18" x D18" \$397 * No Custom Sizes- Incontinence Cover Only	
<input type="checkbox"/> Lite High(3.0" Thick)		<input type="checkbox"/> W16" x D16" \$408 <input type="checkbox"/> W18" x D16" \$431 <input type="checkbox"/> W18" x D18" \$431 * No Custom Sizes- Incontinence Cover Only	

H CHAIR OPTIONS 3/3

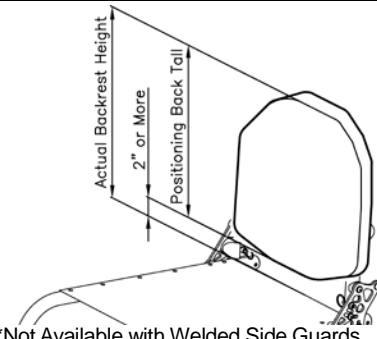
POSITIONING BACK			
<p>*Note : Actual height of the backrest will increase 2" or more.</p> 			
<p>ADI CARBON BACKREST (Support Contour-ACTIVE 2.5") *Not Available with Welded Side Guards</p> <p>Mounting Hardware: <input type="checkbox"/> 2 Point Pro <input type="checkbox"/> Quick Release</p>			
Height	<input type="checkbox"/> LOW (10" Tall) *Backrest Height requires 12" or more *Available 13"-19" width Width (") E2613	\$ 745	
	<input type="checkbox"/> Medium (13" Tall) *Backrest Height requires 15" or more *Available 13"-19" width Width (") E2613	\$ 815	
<input type="checkbox"/> Add Privacy Flap (\$60 up charge)	<input type="checkbox"/> Standard (16" Tall) *Backrest Height requires 18" or more *Available 13"-19" width Width (") E2613	\$ 880	
	<input type="checkbox"/> Custom Size (" Tall) x (" width) E2613	\$ CFP	
<p>ADI ALUMINUM BACKREST (Support Contour-ACTIVE 2.5") *Not Available with Welded Side Guards</p> <p>Mounting Hardware: <input type="checkbox"/> 2 Point Pro <input type="checkbox"/> Quick Release</p>			
Height	<input type="checkbox"/> LOW (10" Tall) *Backrest Height requires 12" or more *Available 10"-20" width Width (") E2613	\$ 610	
	<input type="checkbox"/> Medium (13" Tall) *Backrest Height requires 15" or more *Available 12"-20" width Width (") E2613	\$ 625	
	<input type="checkbox"/> Standard (16" Tall) *Backrest Height requires 18" or more *Available 14"-20" width Width (") E2613	\$ 640	
	<input type="checkbox"/> Tall (18" Tall) *Backrest Height requires 20" or more *Available 16"-20" width Width (") E2613	\$ 655	
<input type="checkbox"/> Add Privacy Flap (\$60 up charge)	<input type="checkbox"/> X-Tall (20" Tall) *Backrest Height requires 22" or more *Available 16"-20" width Width (") E2613	\$ 670	
	<input type="checkbox"/> Custom Size (" Tall) x (" width) E2613	\$ CFP	
<p>ADI ALUMINUM BACKREST (Support Contour-DEEP 4") *Not Available with Welded Side Guards *Not Available with Lateral Supports</p> <p>Mounting Hardware: <input type="checkbox"/> 2 Point Pro <input type="checkbox"/> Quick Release</p>			
Height	<input type="checkbox"/> LOW (10" Tall) *Backrest Height requires 12" or more *Available 10"-20" width Width (") E2615	\$ 710	
	<input type="checkbox"/> Medium (13" Tall) *Backrest Height requires 15" or more *Available 12"-20" width Width (") E2615	\$ 725	
	<input type="checkbox"/> Standard (16" Tall) *Backrest Height requires 18" or more *Available 14"-20" width Width (") E2615	\$ 740	
	<input type="checkbox"/> Tall (18" Tall) *Backrest Height requires 20" or more *Available 16"-20" width Width (") E2615	\$ 755	
<input type="checkbox"/> Add Privacy Flap (\$60 up charge)	<input type="checkbox"/> X-Tall (20" Tall) *Backrest Height requires 22" or more *Available 16"-20" width Width (") E2615	\$ 770	
	<input type="checkbox"/> Custom Size (" Tall) x (" width) E2615	\$ CFP	
<p>ADI LATERAL SUPPORTS (Lateral Supports are compatible with only active 2.5" ADI positioning back.)</p>			
<input type="checkbox"/> Stationary Pad	Pad Size <input type="checkbox"/> Small (3" H x 3" D) <input type="checkbox"/> Medium(3" H x 4" D) <input type="checkbox"/> Large(4.5" H x 4.5" D) <input type="checkbox"/> Large(4" H x 6" D)		
	<input type="checkbox"/> Pair	\$ 320	
	<input type="checkbox"/> Left side only or <input type="checkbox"/> Right side only	\$ 160	
<input type="checkbox"/> Swing-Out	Pad Size <input type="checkbox"/> Small (3" H x 3" D) <input type="checkbox"/> Medium(3" H x 4" D) <input type="checkbox"/> Large(4.5" H x 4.5" D) <input type="checkbox"/> Large(4" H x 6" D)		
	<input type="checkbox"/> Pair	\$ 520	
	<input type="checkbox"/> Left side only or <input type="checkbox"/> Right side only	\$ 260	
OTHER			
<input type="checkbox"/> ADI Transfer Board	<input type="checkbox"/> 21" (ADV21) <input type="checkbox"/> 24" (ADV24) <input type="checkbox"/> 29" (ADV29)	\$ 62	
<input type="checkbox"/> ADI Push and Transfer Gloves	Leather (one size fits)	\$ 60	
<input type="checkbox"/> ADI Carbon Solid Seat	(Wide: 18" Max, Depth: 20") ✘ ONLY AVAILABLE WITH COLOURS NON-REMOVABLE SIDE GUARDS	\$ 625	
VARILITE® Seating Systems Available			CFP
Please visit for all options. www.varilite.com			
NOTE			