

SHOCK BLADE

ORDER FORM 2022

Tel: 951-808-9131 FAX: 951-808-9949
Toll Free: 800-892-8998 www.colourswheelchair.com

| DEALER | | COLOURS INFORMATION For Office Use Only | |
|------------------|--------|---|------|
| Dealer: | | Order Date: | S/N: |
| Account: | P.O.#: | | |
| Ordered By: | | | |
| Customer Name: | | | |
| Customer Weight: | | | |

| CHAIR INFORMATION | PRICE |
|--|---|
| New SHOCK BLADE K0005 | Base Wheel Chair Price K0005 \$ 2,832 |
| 7000 series aluminum frame | Air Ride System \$ 1,930 |
| Fixed FSH-RSH with Air Ride System Suspension (E1015) | Total Section A \$ |
| Max. Capacity 250Lbs | Total Section B \$ |
| NOTE | Total Section C(Custom Parts Color) \$ |
| Main Frame : Lifetime Warranty(5 years) | Total Section D \$ |
| *See warranty policy | Total Section E \$ |
| | Total Section F \$ |
| | Total Section G \$ |
| | Total Section H \$ |
| | ORDER GRAND TOTAL \$ |

A FRAME COLORS & PARTS COLORS Heavy Duty Frame(250-300lbs) \$750

| FRAME COLORS | <input type="checkbox"/> Tiffany Blue | <input type="checkbox"/> Sparkle Burgundy | <input type="checkbox"/> Neon Yellow* | <input type="checkbox"/> Brass Metallic | <input type="checkbox"/> Shocker Yellow | |
|----------------------|--|---|---|---|---|--------------------------------------|
| Powder-Coated | <input type="checkbox"/> Gloss Black | <input type="checkbox"/> Twilight Flake | <input type="checkbox"/> Yellow | <input type="checkbox"/> Magenta | <input type="checkbox"/> Fire Engine Red | <input type="checkbox"/> White |
| | <input type="checkbox"/> Candy Blue | <input type="checkbox"/> Candy Purple | <input type="checkbox"/> Candy Green | <input type="checkbox"/> Candy Red | <input type="checkbox"/> Candy Raspberry | <input type="checkbox"/> Cobalt Blue |
| | <input type="checkbox"/> Matte Gray | <input type="checkbox"/> Matte Purple | <input type="checkbox"/> Matte Blue | <input type="checkbox"/> Matte Green | <input type="checkbox"/> Matte Black | <input type="checkbox"/> Matte Red |
| | <input type="checkbox"/> Reed Green | <input type="checkbox"/> Neon Green | <input type="checkbox"/> Orange Sparkle | <input type="checkbox"/> Mellon Yellow | <input type="checkbox"/> Gun Smoke Silver | <input type="checkbox"/> Blue Lilac |
| | <input type="checkbox"/> Neon Red | <input type="checkbox"/> Granny Sparkle Green | <input type="checkbox"/> Sparkle Sky Blue | | | \$ STD |
| Specials | <input type="checkbox"/> Polished Aluminum..... | | | | | \$ 920 |
| | <input type="checkbox"/> 24 karat Gold Plated..... | | | | | \$ CFP |

| PARTS COLORS (Custom Parts Color Section, Please see Section F) | | |
|--|--|--------|
| STD Color | Black Color (*Suspension Springs-Silver Color Only.....) | \$ STD |
| Custom Color Main Bolt on Parts One Color Package | <input type="checkbox"/> Powder-Coated ()..... | \$ 575 |
| Including: Backrest, Foot Plate, Footrest Rings, Backrest Brackets, Saddle Stops, Forks & Knurl Nuts, Caps, Front Suspension Springs *marked parts | <input type="checkbox"/> Polished..... | \$ 863 |
| | <input type="checkbox"/> 24 karat Gold..... Plated- | \$ CFP |
| Custom Color Suspension Unit One Color Package | <input type="checkbox"/> Powder-Coated ()..... | \$ 437 |
| Including: Axle Holders, Upper A-Arms, Lower A-Arms, Suspension Main Frame *marked parts | <input type="checkbox"/> Polished..... | \$ 920 |
| | <input type="checkbox"/> 24 karat Gold..... Plated- | \$ CFP |

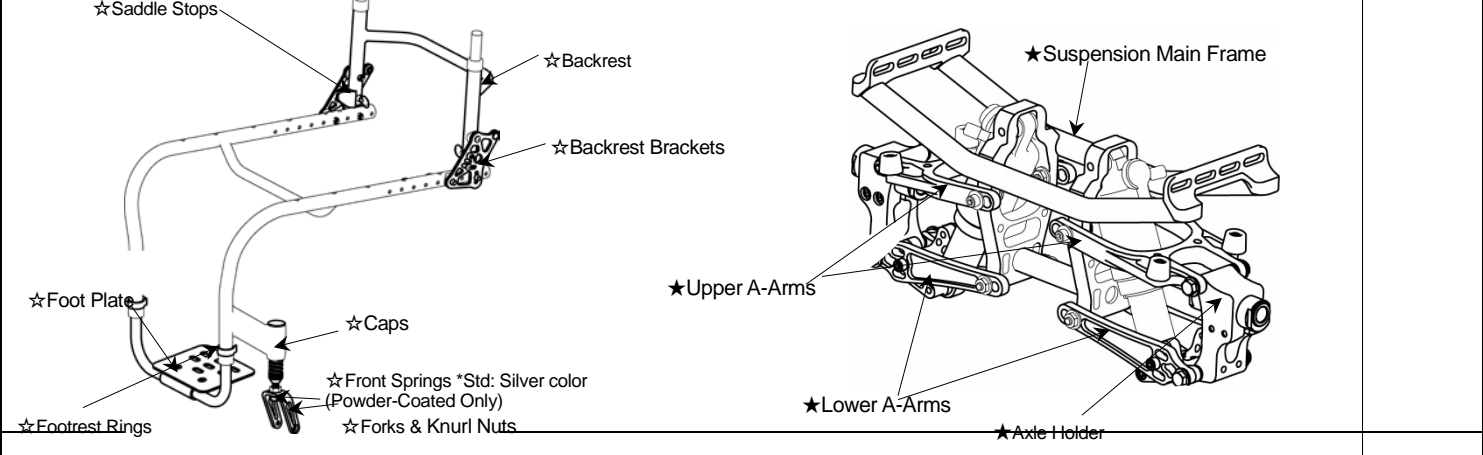

B FRAME MEASUREMENTS 1/2

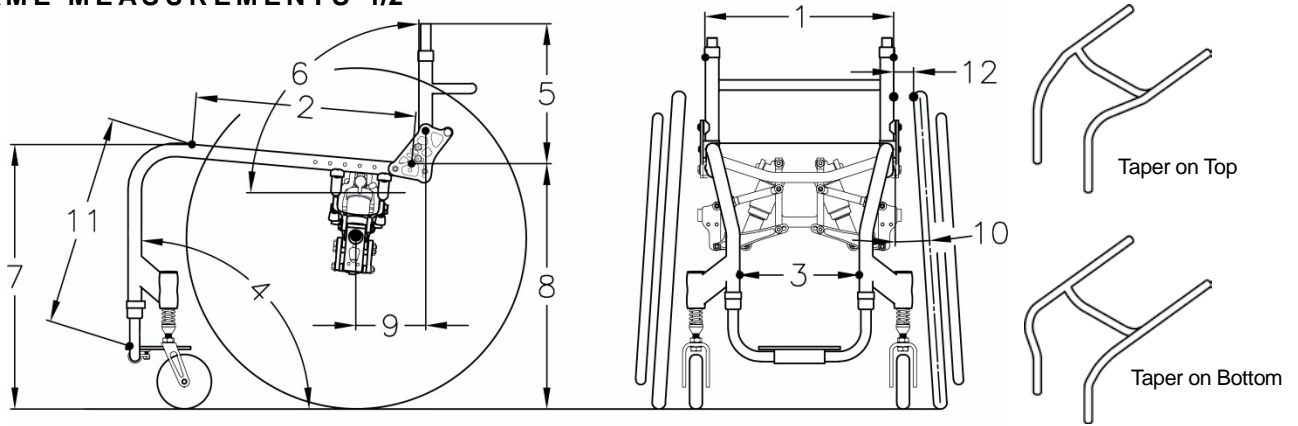

| 1. SEAT WIDTH | <input type="checkbox"/> 13" <input type="checkbox"/> 14" <input type="checkbox"/> 15" <input type="checkbox"/> 16" <input type="checkbox"/> 17" <input type="checkbox"/> 18" <input type="checkbox"/> 19" | \$ STD | | | | | | | | |
|---|---|---------------------|-----------------|------------|-----------|-------------|-------------|-------------|------------|--|
| | <input type="checkbox"/> 20" E2201 | \$ 345 | | | | | | | | |
| 2. SEAT DEPTH | <input type="checkbox"/> 13" <input type="checkbox"/> 14" <input type="checkbox"/> 15" <input type="checkbox"/> 16" <input type="checkbox"/> 17" <input type="checkbox"/> 18" <input type="checkbox"/> 19" | \$ STD | | | | | | | | |
| * Only Choose One Option | <input type="checkbox"/> Net Seat Depth E2203 | \$ 345 | | | | | | | | |
| | <input type="checkbox"/> Depth Adj. Frame | | | | | | | | | |
| | <input type="checkbox"/> Short Frame (16" Depth) Set at <input type="checkbox"/> 13" <input type="checkbox"/> 14" <input type="checkbox"/> 15" <input type="checkbox"/> 16" .. | \$ STD | | | | | | | | |
| | <input type="checkbox"/> Long Frame (19" Depth) Set at <input type="checkbox"/> 16" <input type="checkbox"/> 17" <input type="checkbox"/> 18" <input type="checkbox"/> 19" .. | \$ STD | | | | | | | | |
| | <input type="checkbox"/> Aluminum Seat Base (250-300lbs) E2231 | \$ 282 | | | | | | | | |
| | <input type="checkbox"/> Positioning Frame Add (") | \$ 173 | | | | | | | | |
| | <input type="checkbox"/> Ergo Seat Tubing Depth (") | \$ 230 | | | | | | | | |
| | *Measurement must be 2.5" longer than your Center of Gravity | | | | | | | | | |
| 3. FOOTREST WIDTH | <input type="checkbox"/> STD (Seat Width Minus 5") <input type="checkbox"/> Taper on Top <input type="checkbox"/> Taper on Bottom | \$ STD | | | | | | | | |
| | <input type="checkbox"/> Custom (") <input type="checkbox"/> Taper on Top <input type="checkbox"/> Taper on Bottom | \$ 173 | | | | | | | | |
| | <input type="checkbox"/> No Taper (Seat Width Minus 2")-. | \$ STD | | | | | | | | |
| FOOT PLATE STYLE | <input type="checkbox"/> Standard single loop with adjust. height & angle. STD Foot Plate | \$ STD | | | | | | | | |
| | <input type="checkbox"/> Single Flip-Back-single loop (no riser avail) with adjust. height & angle. STD Foot Plate K0040, K0045 | \$ 173 | | | | | | | | |
| | <input type="checkbox"/> No Foot Plate with extra stabilizer bar for foot propel (amputee) | \$ 288 | | | | | | | | |
| | STD Foot Plate Size Chart <table border="1" style="display: inline-table; margin-left: 20px;"> <thead> <tr> <th>Your Footrest Width</th> <th>Foot Plate Size</th> </tr> </thead> <tbody> <tr> <td>8.5"-10.0"</td> <td>W6.5"xD5"</td> </tr> <tr> <td>10.5"-13.0"</td> <td>W8.5"xD6.5"</td> </tr> <tr> <td>13.5"-17.0"</td> <td>W11"xD6.5"</td> </tr> </tbody> </table> | Your Footrest Width | Foot Plate Size | 8.5"-10.0" | W6.5"xD5" | 10.5"-13.0" | W8.5"xD6.5" | 13.5"-17.0" | W11"xD6.5" | |
| Your Footrest Width | Foot Plate Size | | | | | | | | | |
| 8.5"-10.0" | W6.5"xD5" | | | | | | | | | |
| 10.5"-13.0" | W8.5"xD6.5" | | | | | | | | | |
| 13.5"-17.0" | W11"xD6.5" | | | | | | | | | |
| | | | | | | | | | | |
| CUSTOM FOOT PLATE | <input type="checkbox"/> Custom Foot Plate with adjust. height & angle | \$ 100 | | | | | | | | |
| <input type="checkbox"/> Foot Propel w/ Stabilizer Bar Style (\$250 up charge) | *Available Solid Plate Only | | | | | | | | | |
| <input type="checkbox"/> Add Anti-Skid Tape (\$20 up charged) | <input type="checkbox"/> Custom Tubular Footrest | \$ 288 | | | | | | | | |
| | | | | | | | | | | |
| | <input type="checkbox"/> With ABS Foot Plate (\$75 up charge) | | | | | | | | | |
| 4. FRAME ANGLE | <input type="checkbox"/> 75° <input type="checkbox"/> 80° <input type="checkbox"/> 85° <input type="checkbox"/> 90° to the ground | \$ STD | | | | | | | | |
| | <input type="checkbox"/> Custom (°) to the ground *Up to 65° | \$ NCO | | | | | | | | |

B FRAME MEASUREMENTS 2/2

| 5. BACKREST HEIGHT | <input type="checkbox"/> 8" <input type="checkbox"/> 9" <input type="checkbox"/> 10" <input type="checkbox"/> 11" <input type="checkbox"/> 12" <input type="checkbox"/> 13" <input type="checkbox"/> 14" <input type="checkbox"/> 15" <input type="checkbox"/> 16" <input type="checkbox"/> 17" <input type="checkbox"/> 18" | \$ STD | | | | | | | | | | | | | | |
|---|---|-------------------|-------------------|-------------|---------------|-----------------|---------------|-------------|---------------|-------------|---------------|-------------|---------------|----------------|---------------|--|
| * Rigidizer bar 3.25" deep std. | | | | | | | | | | | | | | | | |
| TYPE | <input type="checkbox"/> Locking mechanism with adjust. height & angle | \$ STD | | | | | | | | | | | | | | |
| | <input type="checkbox"/> Double Locking mechanism with adjust. height & angle | \$ 29 | | | | | | | | | | | | | | |
| | <input type="checkbox"/> Folding with adjust. height & angle | \$ NCO | | | | | | | | | | | | | | |
| CUSTOM | <input type="checkbox"/> Welded Backrest Angle Set at (") to the ground *Non Folding Backrest . . . only. | \$ 173 | | | | | | | | | | | | | | |
| | <input type="checkbox"/> Welded Side Guards *Non Folding Backrest only. | \$ 518 | | | | | | | | | | | | | | |
| | <input type="checkbox"/> Custom Backrest | \$ 173 | | | | | | | | | | | | | | |
| | (ie: double rigidizer bars, custom depth, custom height, etc) | | | | | | | | | | | | | | | |
| | | | | | | | | | | | | | | | | |
| 6. BACKREST ANGLE | Set at (°) to the ground *STD 90° | \$ STD | | | | | | | | | | | | | | |
| 7. FRONT SEAT HEIGHT | <input type="checkbox"/> 16.0" <input type="checkbox"/> 16.5" <input type="checkbox"/> 17.0" <input type="checkbox"/> 17.5" <input type="checkbox"/> 18.0" <input type="checkbox"/> 18.5" <input type="checkbox"/> 19.0" <input type="checkbox"/> 19.5" <input type="checkbox"/> 20.0" <input type="checkbox"/> 20.5" <input type="checkbox"/> 21.0" | \$ STD | | | | | | | | | | | | | | |
| Front Seat Height Ranges | | | | | | | | | | | | | | | | |
| | <table border="1"> <thead> <tr> <th>Caster Wheel Size</th> <th>Front Seat Height</th> </tr> </thead> <tbody> <tr> <td>3" Caster</td> <td>16.0" - 19.5"</td> </tr> <tr> <td>4" Caster</td> <td>16.0" - 20.0"</td> </tr> <tr> <td>5" Caster</td> <td>16.0" - 21.0"</td> </tr> </tbody> </table> | Caster Wheel Size | Front Seat Height | 3" Caster | 16.0" - 19.5" | 4" Caster | 16.0" - 20.0" | 5" Caster | 16.0" - 21.0" | | | | | | | |
| Caster Wheel Size | Front Seat Height | | | | | | | | | | | | | | | |
| 3" Caster | 16.0" - 19.5" | | | | | | | | | | | | | | | |
| 4" Caster | 16.0" - 20.0" | | | | | | | | | | | | | | | |
| 5" Caster | 16.0" - 21.0" | | | | | | | | | | | | | | | |
| 8. REAR SEAT HEIGHT | <input type="checkbox"/> 16.0" <input type="checkbox"/> 16.5" <input type="checkbox"/> 17.0" <input type="checkbox"/> 17.5" <input type="checkbox"/> 18.0" <input type="checkbox"/> 18.5" <input type="checkbox"/> 19.0" | \$ STD | | | | | | | | | | | | | | |
| Rear Seat Height Ranges | | | | | | | | | | | | | | | | |
| | <table border="1"> <thead> <tr> <th>Rear Tire Size</th> <th>Rear Seat Height</th> </tr> </thead> <tbody> <tr> <td>24"x1"(540)</td> <td>16.0" - 18.5"</td> </tr> <tr> <td>24"x1 3/8"(540)</td> <td>16.5" - 19.0"</td> </tr> <tr> <td>25"x1"(559)</td> <td>16.5" - 19.0"</td> </tr> <tr> <td>24"x2"(540)</td> <td>17.0" - 19.0"</td> </tr> <tr> <td>26"x1"(590)</td> <td>17.0" - 19.0"</td> </tr> <tr> <td>25"x1.95"(559)</td> <td>17.0" - 19.0"</td> </tr> </tbody> </table> | Rear Tire Size | Rear Seat Height | 24"x1"(540) | 16.0" - 18.5" | 24"x1 3/8"(540) | 16.5" - 19.0" | 25"x1"(559) | 16.5" - 19.0" | 24"x2"(540) | 17.0" - 19.0" | 26"x1"(590) | 17.0" - 19.0" | 25"x1.95"(559) | 17.0" - 19.0" | |
| Rear Tire Size | Rear Seat Height | | | | | | | | | | | | | | | |
| 24"x1"(540) | 16.0" - 18.5" | | | | | | | | | | | | | | | |
| 24"x1 3/8"(540) | 16.5" - 19.0" | | | | | | | | | | | | | | | |
| 25"x1"(559) | 16.5" - 19.0" | | | | | | | | | | | | | | | |
| 24"x2"(540) | 17.0" - 19.0" | | | | | | | | | | | | | | | |
| 26"x1"(590) | 17.0" - 19.0" | | | | | | | | | | | | | | | |
| 25"x1.95"(559) | 17.0" - 19.0" | | | | | | | | | | | | | | | |
| | *No Custom Modifications | | | | | | | | | | | | | | | |
| 9. CENTER OF GRAVITY | <input checked="" type="checkbox"/> 1.5" <input checked="" type="checkbox"/> 2.0" <input type="checkbox"/> 2.5" <input type="checkbox"/> 3.0" <input type="checkbox"/> 3.5" <input type="checkbox"/> 4.0" <input type="checkbox"/> 4.5" <input type="checkbox"/> 5.0" *Not Available w / Net Seat Depth Frame | \$ STD | | | | | | | | | | | | | | |
| 10. CAMBER ANGLE | <input type="checkbox"/> 2° <input type="checkbox"/> 4° | \$ STD | | | | | | | | | | | | | | |
| 11. FRONT OF SEAT SLING TO FRONT OF FOOTREST | <input type="checkbox"/> 15.0" <input checked="" type="checkbox"/> 15.5" <input checked="" type="checkbox"/> 16.0" <input type="checkbox"/> 16.5" <input type="checkbox"/> 17.0" <input type="checkbox"/> 17.5" <input type="checkbox"/> 18.0" <input type="checkbox"/> 18.5" <input type="checkbox"/> 19.0" <input type="checkbox"/> 19.5" *Not Available w / 19.0", 19.5", 20.0", 20.5", 21.0" Front Seat Height *Measurement must be 1.5" shorter than your Front Seat Height | \$ STD | | | | | | | | | | | | | | |
| HIGH MOUNT With Risers or Clamps | <input type="checkbox"/> 11.0" <input type="checkbox"/> 11.5" <input type="checkbox"/> 12.0" <input type="checkbox"/> 12.5" <input type="checkbox"/> 13.0" <input type="checkbox"/> 13.5" <input type="checkbox"/> 14.0" <input type="checkbox"/> 14.5" <input type="checkbox"/> 15.0" <input type="checkbox"/> 15.5" <input type="checkbox"/> 16.0" | \$ 75 | | | | | | | | | | | | | | |
| | | K0040 | | | | | | | | | | | | | | |
| 12. INSIDE WHEEL CLEARANCE | <input type="checkbox"/> 3/4"* <input type="checkbox"/> 1" <input type="checkbox"/> 1 1/4" <input type="checkbox"/> 1 1/2" <input type="checkbox"/> 1 3/4" <input type="checkbox"/> 2" *3/4" Inside wheel clearance not available with 2 degree camber. (with the exception of Y-360 wheels) *3/4" Inside wheel clearance not available with Armrest | \$ STD | | | | | | | | | | | | | | |
| REAR SUSPENSION RATING | <input type="checkbox"/> Set up 50psi (For 80 lbs-110 lbs weight) <input type="checkbox"/> Set up 100psi (For 170 lbs-200 lbs weight) <input type="checkbox"/> Set up 60psi (For 110 lbs-140 lbs weight) <input type="checkbox"/> Set up 120psi (For 200 lbs-230 lbs weight) <input type="checkbox"/> Set up 80psi (For 140 lbs-170 lbs weight) <input type="checkbox"/> Set up 150psi (For 230 lbs-250 lbs weight) | \$ STD | | | | | | | | | | | | | | |
| SHOCK OPTION | <input checked="" type="checkbox"/> Fox Racing Shox 300 HP Pump *Customer Needs Pump To Adjust Rear Suspension Rating <input type="checkbox"/> Omit Air Pro System | \$ STD \$ -350 | | | | | | | | | | | | | | |
| Pick Color AirTubes: | <input type="checkbox"/> Black <input type="checkbox"/> Yellow <input type="checkbox"/> Orange <input type="checkbox"/> Blue <input type="checkbox"/> Red | | | | | | | | | | | | | | | |

1. SEAT WIDTH

Measure from outside of seat tube to the outside of the opposite seat tube.

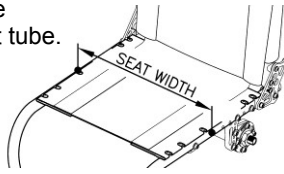

2. SEAT DEPTH

Measure from at the front bottom of backrest tube to the front edge of seat sling.

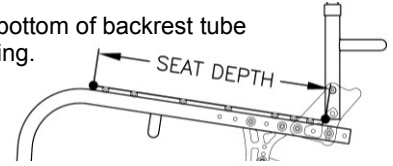

3. FOOTREST WIDTH

Measure from inside of front frame tube to inside of opposite front frame tube.

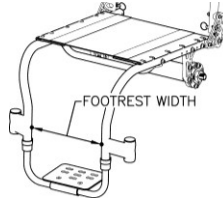

4. FRAME ANGLE

Measure angle frame front to floor.

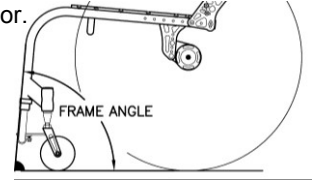

5. BACKREST HEIGHT

Measure from top of back post to seat sling at front bottom of backrest tube.

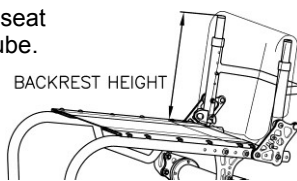

6. BACKREST ANGLE

Measure angle from front of back post to floor.

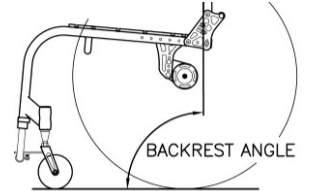

7. FRONT SEAT HEIGHT

Measure from floor to top of seat sling at front edge.

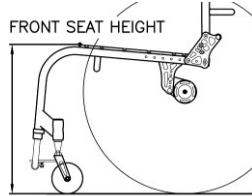

8. REAR SEAT HEIGHT

Measure from floor to top of seat sling at front bottom of backrest tube.

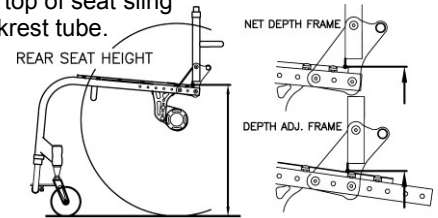

9. CENTER OF GRAVITY

Measure from center of back tube at the folding pivot to the center of the rear axle.

(If welding backrest is selected, Measure from center of back tube at the seat tube to the center of the rear axle.)

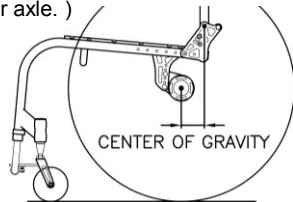

10. CAMBER ANGLE

Measure angle from wheel to vertical at floor.

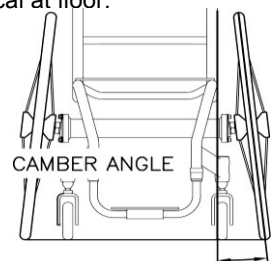

11. FRONT OF SEAT SLING TO FOOTREST

ADULT CHAIR

Measure from top of seat sling at front edge to top of foot plate at front edge.

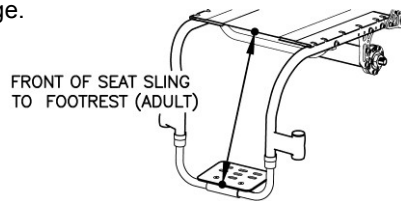

PEDIATRIC CHAIR

Measure vertical from top of seat sling at front edge to top of foot plate.



12. INSIDE WHEEL CLEARANCE

Measure from outside of seat back tube to inside of rear tire.

(If side guards are selected, measure from outside of side guards to inside of rear tire.)

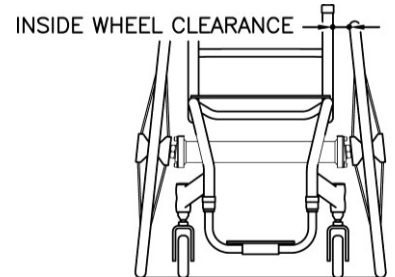

C SPECIAL PARTS COLORS (Please allow an additional 1-2 weeks delivery)

| PARTS COLORS | | | | | | |
|----------------------|-------------|----------------------|------------------|---------------|------------------|-------------|
| Powder-Coated | Gloss Black | Twilight Flake | Yellow | Magenta | Fire Engine Red | White |
| Neon Red | Candy Blue | Candy Purple | Candy Green | Candy Red | Candy Raspberry | Cobalt Blue |
| Brass Metal | Matte Gray | Matte Purple | Matte Blue | Matte Green | Matte Black | Matte Red |
| Sparkle | Reed Green | Neon Green | Orange Sparkle | Mellon Yellow | Gun Smoke Silver | Blue Lilac |
| Burgundy | Neon Yellow | Granny Sparkle Green | Sparkle Sky Blue | | | |

| | | |
|-----------------------|----------------------|--|
| Special Colors | Polished Aluminum | |
| | 24 karat Gold Plated | *Please allow an additional 4 weeks delivery |

Please Choose the Color for each Part

*Parts not selected will be black color. (Suspension Spring: Silver Color)
 *Minimum 3 parts selected per order.

*PC=Powder-Coated

Saddle Stops

- PC () \$46
- Polished \$132
- Gold Plated \$CFP

Backrest Frame

- PC () \$144
- Polished \$259
- Gold Plated CFP

Backrest Brackets

- PC () \$104
- Polished \$132
- Gold Plated \$CFP

Footrest Rings

- PC () \$23
- Polished \$46
- Gold Plated \$CFP

Footrest Tubes

- PC N/A
- Polished \$98
- Gold Plated \$CFP

Footrest Clamps

- PC () \$58
- Polished \$86
- Gold Plated \$CFP

Caps

- PC () \$23
- Polished N/A
- Gold Plated N/A

Front Springs

- PC () \$23
- Polished N/A
- Gold Plated N/A

Forks & Knurl Nuts

- PC () \$75
- Polished \$104
- Gold Plated \$CFP

Suspension Main Frame

- PC () \$173
- Polished \$460
- Gold Plated \$CFP

Upper A-Arms

- PC () \$115
- Polished \$345
- Gold Plated \$CFP

Lower A-Arms

- PC () \$115
- Polished \$322
- Gold Plated \$CFP

Axle Receiver Holder

- PC () \$69
- Polished \$207
- Gold Plated \$CFP

D COMPONENTS

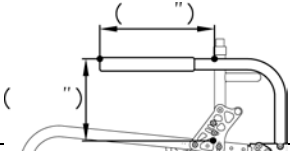
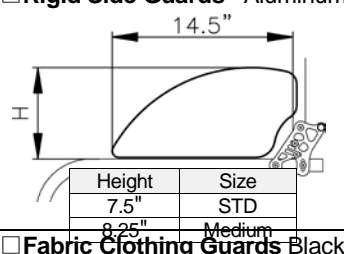
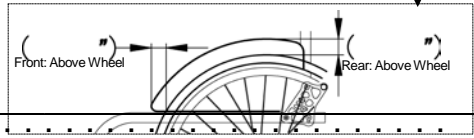
| | | | |
|---|---|---|--------|
| WHEEL LOCKS | | | |
| <input type="checkbox"/> New Solutions Push to Lock | <input type="checkbox"/> w/ 2" Extension Handle (\$80up charge) | | \$ STD |
| <input type="checkbox"/> Gallop Push to Lock / Anodized | | | \$ STD |
| <input type="checkbox"/> Question Mark Style Scissor | | | \$ 70 |
| <input type="checkbox"/> NEW Compact Scissor Lock / Anodized Black Only | | | \$ 127 |
| <input type="checkbox"/> Gallop Scissor Lock / Anodized | | | \$ 127 |
| PUSH HANDLES | | *If you are ordering push handles, You must select the backrest locking mechanism. | |
| <input type="checkbox"/> Integrated w/Fixed Backrest Height / Anodized Black Only | | | \$ STD |
| <input type="checkbox"/> Bolt-on / Anodized Black Only | Specify Height from floor -()" | | \$ 163 |
| <input type="checkbox"/> Bolt-on w/Quick Release / Anodized Black Only | Specify Height from floor -()" | | \$ 219 |
| <input type="checkbox"/> NEW Height Adj. / Anodized Black Only | Specify Maximum height from floor -()" | | \$ 339 |
| NEW ARM RESTS | | Anodized Black Only | |
| <input type="checkbox"/> Fixed Tubular Armrest | Adj. Angle and Height | Height from seat sling Set at : <input type="checkbox"/> 8" <input type="checkbox"/> 9" <input type="checkbox"/> 10" <input type="checkbox"/> 11" <input type="checkbox"/> 12" E0973 | \$ 288 |
| <input type="checkbox"/> Swing Away Tubular Armrest | Adj. Angle and Height | Height from seat sling Set at : <input type="checkbox"/> 8" <input type="checkbox"/> 9" <input type="checkbox"/> 10" <input type="checkbox"/> 11" <input type="checkbox"/> 12" E0973 | \$ 288 |
| <input type="checkbox"/> Flip-Up Armrest | <input type="checkbox"/> w/Fixed Tubular Armrest | Height from seat sling Set at : <input type="checkbox"/> 8" <input type="checkbox"/> 9" <input type="checkbox"/> 10" <input type="checkbox"/> 11" <input type="checkbox"/> 12" E0973 | \$ 288 |
| | Adj. Angle <input type="checkbox"/> w/ Swing Away Tubular Armrest | Height from seat sling Set at : <input type="checkbox"/> 8" <input type="checkbox"/> 9" <input type="checkbox"/> 10" <input type="checkbox"/> 11" <input type="checkbox"/> 12" E0973 | \$ 288 |
| <input type="checkbox"/> Custom Length & Height (\$150 up charge) | | *Specify Height & Length → | |
| | |  | |
| ANTI-TIPPERS | | | |
| <input type="checkbox"/> Removable Anti-tipper(pair) Anodized Black Only | | E0971 | \$ 253 |
| <input type="checkbox"/> Press Release Removable Anti-tipper(pair) | | E0971 | \$ 288 |
| SIDE GUARDS | | | |
| <input type="checkbox"/> Rigid Side Guards - Black ABS | <input type="checkbox"/> Non-Removable <input type="checkbox"/> Removable <input type="checkbox"/> Removable w/Hole (\$12 up charge) | | \$ 163 |
| Color: Black Only | Size: <input type="checkbox"/> STD <input type="checkbox"/> Medium <input type="checkbox"/> Cut to Wheel (\$98 up charge) | Measurement | |
| <input type="checkbox"/> Rigid Side Guards - Aluminum | <input type="checkbox"/> Non-Removable <input type="checkbox"/> Removable | | \$ 227 |
|  | Size: <input type="checkbox"/> Medium Only <input type="checkbox"/> Cut to Wheel (\$98 up charge) | Measurement | |
| | Color <input type="checkbox"/> Black (STD) <input type="checkbox"/> Pol. Aluminum (STD) <input type="checkbox"/> Powder Coated () (\$120 up charge) <input type="checkbox"/> Gold Plate (+CFP) | | |
| <input type="checkbox"/> Fabric Clothing Guards Black Nylon w/Velcro | | | \$ 94 |
|  | | | |
| SEAT CUSHION | | -*Please see section for other cushion choices.- | |
| <input type="checkbox"/> Foam Cushion | w/Nylon Black Cover Thickness <input type="checkbox"/> 1" <input type="checkbox"/> 2" <input type="checkbox"/> 3" <input type="checkbox"/> 4" | | \$ CFP |
| <input type="checkbox"/> Custom Cushion Cover | (Std. Foam Cushion Only) -Select Fabric () (\$90 up charge) | | |
| ACCESSORIES | | | |
| <input type="checkbox"/> Frame Protectors / Black Leather/Zipper Type | | | \$ 94 |
| <input type="checkbox"/> Gel Ovation Protector Wraps Gel Silicone | | | \$ 115 |
| <input type="checkbox"/> E0978 Seat Belt w/Auto Buckle (BP) 1.5" Black Belt Only | | E0978 | \$ 98 |
| <input type="checkbox"/> Tie Down Brackets 4pcs. | | | \$ 242 |
| <input type="checkbox"/> Calf Strap <input type="checkbox"/> Black <input type="checkbox"/> Matching Fabric (\$55 up charge) -Select Fabric () | | | \$ 29 |
| <input type="checkbox"/> Bodypoint Padded Calf Strap <input type="checkbox"/> (14"-16" footrest width) <input type="checkbox"/> (16"-20" footrest width) <input type="checkbox"/> (20"-24" footrest) | \$77 \$83 \$89 | | |
| <input type="checkbox"/> Hanging Zipper Pouch <input type="checkbox"/> Black <input type="checkbox"/> Matching Fabric (\$60) or <input type="checkbox"/> Leather (\$75) Custom Size Width: Length: | | | \$ 75 |
| <input type="checkbox"/> Matching Fabric on Padded Side Guards -Select Fabric () | | | \$ 242 |
| UPHOLSTERY CHOICE & COLOR | | *Positioning Back Available. Please see Section E | |
| <input type="checkbox"/> Standard Adjustable Height Backrest | (Black) | | \$ STD |
| <input type="checkbox"/> Adjustable Tension Backrest | Black Only (*Not available with 8" Backrest Height) | | \$ 150 |
| Options | <input type="checkbox"/> Fun Fabric: For Std. or Adj. Style (Choose From Choices on Page 7 and write below) (\$ 80 up charge) | | |
| | <input type="checkbox"/> Backrest Leather Trim (outside panels) (\$ up charge) | | \$ CFP |

FABRIC CHOICE SHEET

1. Camouflage Girls

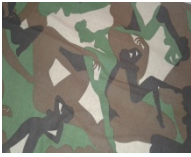

2. Purple Zebra



3. Silver Grey Snake



5. Laughing Skulls



6. Purple Snake



7. Sweetheart Pinup Girls



9. Blue Flames

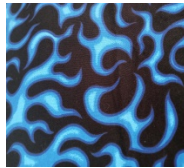

10. Arctic Camo



11. Furry Friends



12. Supercars



13. Urban Camo

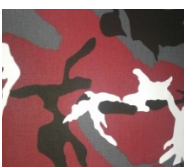

14. Superbikes



15. Sizzle Flames



16. Hot Rod Flames



17. Skulls w/ Attitude



18. Sweet Pink

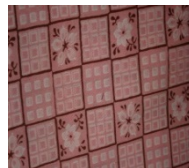

19. Heart and Soul



20. Home Run



21. Fuzzy Giraffe

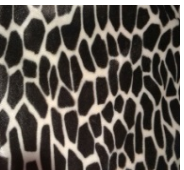

22. Cheetah



23. Paperweight Cobalt



24. Zig Zag Dots



25. Smokey Tribal Flames

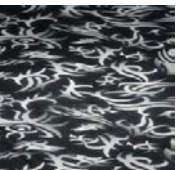

26. Rose and Rebellion



27. Tattoo Adventure(Cream

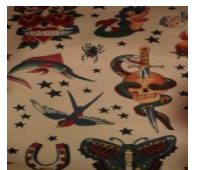

28. Red Tribal Flames

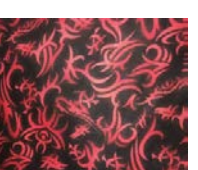

29. Tattoo Adventure(Black)

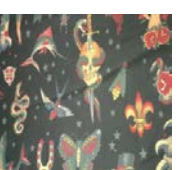

30. Butterfly Bandana

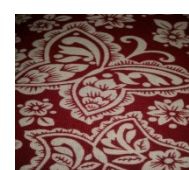

31. Tatsu Dragon

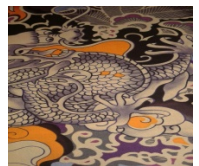



E TIRES, CASTERS, & FORKS

| TIRES | | | | | | |
|-----------------------------|--|---|--|--|--------------------|---------------------|
| <input type="checkbox"/> | Primo High Pressure Tire | <input type="checkbox"/> 24"x1" <input type="checkbox"/> 25"x1" <input type="checkbox"/> 26"x1" | Gray Tire w/ black line | | E2211/E2212 | \$ STD |
| <input type="checkbox"/> | Primo High Pressure Tire | <input type="checkbox"/> 24"x1" <input type="checkbox"/> 25"x1" or <input type="checkbox"/> 26"x1" | <input type="checkbox"/> Blue <input type="checkbox"/> Red | | E2211/E2212 | \$ 98 |
| <input type="checkbox"/> | Low Pressure Tire | <input type="checkbox"/> 24"x1-3/8" or <input type="checkbox"/> 26"x1-3/8" | Gray Only | | E2211/E2212 | \$ STD |
| <input type="checkbox"/> | Schwalbe Marathon Plus High Pressure Tire | <input type="checkbox"/> 24"x1", <input type="checkbox"/> 25"x1" or <input type="checkbox"/> 26"x1" | Black Only | | E2211/E2212 | \$ 148 |
| <input type="checkbox"/> | Solid Tire | <input type="checkbox"/> 24"x1" <input type="checkbox"/> 25"x1" Black | | | E2218 | \$ 190 |
| <input type="checkbox"/> | Solid Tire | <input type="checkbox"/> 26"x1 Dark Grey | | | | \$ 155 |
| <input type="checkbox"/> | Moderate V-Track Knobby Tire | 24"x1-3/8" (37-540) | Gray Only | | E2211/E2212 | \$ 135 |
| <input type="checkbox"/> | Aggressive Knobby Tire | 24"x 2" (50-540) | Gray Only <input type="checkbox"/> Blue Line <input type="checkbox"/> Red Line | | E2211/E2212 | \$ 135 |
| <input type="checkbox"/> | Aggressive Knobby Tire | 26"x 2" (50-559) | Gray Only <input type="checkbox"/> Blue Line <input type="checkbox"/> Red Line | | E2211/E2212 | \$ 135 |
| <input type="checkbox"/> | Aggressive Knobby Tire | 24" x 1.95"(50-540) | Black Only | | E2211/E2212 | \$ 135 |
| <input type="checkbox"/> | E2211 Bell Mountain Bike Tire in Flat Defense | (559) 26" X 1.75 - 2.25 | Black Only | | E2211/E2212 | \$ 135 |
| <input type="checkbox"/> | Flat-Free Inserts For 24"x1-3/8" Tires Only | | | | E2211/E2213 | \$ 135 |
| CASTERS | | | | | | |
| SIZE | TIRE WIDTH | HUB COLOR | TIRE COLOR | DESCRIPTION | | |
| <input type="checkbox"/> 3" | 1" | Black Hub | Black Tire Only | Polyurethane | K0077 | \$ STD |
| <input type="checkbox"/> 3" | 1" | Plastic Black Hub | Clear Tire Only | Lighted, Polyurethane | A9900 | \$ 75 |
| <input type="checkbox"/> 3" | 1" | Red Hub | Red Tire Only | Polyurethane | E2222 | \$ STD |
| <input type="checkbox"/> 3" | 1" | Black Hub | Clear Tire Only | Polyurethane | E2222 | \$ STD |
| <input type="checkbox"/> 3" | 1" | Aluminum Silver Hub | Black Tire Only | Made By Frog Legs | K0071 | \$ 190 |
| <input type="checkbox"/> 3" | 1" | Aluminum Black Hub | Black Tire Only | Made By Frog Legs | E2222 | \$ 190 |
| <input type="checkbox"/> 3" | 1.5" | Aluminum Silver Hub | Black Tire Only | Soft Roll Made By Frog Legs | E2222 | \$ 190 |
| <input type="checkbox"/> 3" | 1.5" | Aluminum Black Hub | Black Tire Only | Soft Roll Made By Frog Legs | E2222 | \$ 190 |
| <input type="checkbox"/> 4" | 1 1/8" | Plastic Black Hub | Black Tire Only | Polyurethane Not Available with Narrow Frog Leg Forks | E2222 | \$ STD |
| <input type="checkbox"/> 4" | 1" | Plastic Black Hub | Clear Only | Lighted, Polyurethane | E2221 | \$ 75 |
| <input type="checkbox"/> 4" | 1" | Aluminum Silver Hub | Black Tire Only | Made By Frog Legs | E2214 | \$ 190 |
| <input type="checkbox"/> 4" | 1" | Aluminum Black Hub | Black Tire Only | Made By Frog Legs | E2214 | \$ 190 |
| <input type="checkbox"/> 4" | 1.5" | Aluminum Silver Hub | Tire <input type="checkbox"/> Black <input type="checkbox"/> Blue <input type="checkbox"/> Red | Soft Roll Made By Frog Legs | E1015 | \$ 190 |
| <input type="checkbox"/> 4" | 1.5" | Aluminum Black Hub | Black Tire Only | Soft Roll Made By Frog Legs | E2214 | \$ 190 |
| <input type="checkbox"/> 5" | 1" | Composite Black | Black Tire Only | Polyurethane | E2222 | \$ STD |
| <input type="checkbox"/> 5" | 1" | Plastic Black Hub | Clear Tire Only | Lighted, Polyurethane | A9900 | \$ 75 |
| <input type="checkbox"/> 5" | 1" | Aluminum Silver Hub | Black Tire Only | Made By Frog Legs | A9900 | \$ 190 |
| <input type="checkbox"/> 5" | 1" | Aluminum Black Hub | Black Tire Only | Made By Frog Legs | E2214 | \$ 190 |
| <input type="checkbox"/> 5" | 1.5" | Aluminum Silver Hub | Tire <input type="checkbox"/> Black <input type="checkbox"/> Blue <input type="checkbox"/> Red | Soft Roll Made By Frog Legs | K0072 | \$ 190 |
| <input type="checkbox"/> 5" | 1.5" | Aluminum Black Hub | Black Tire Only | Soft Roll Made By Frog Legs | E2222 | \$ 190 |
| <input type="checkbox"/> 6" | 1.5" | Aluminum Black Hub | Black Tire Only | Soft Roll Made By Frog Legs | E2222 | \$ 213 |
| <input type="checkbox"/> 6" | 1.5" | Aluminum Silver Hub | Black Tire Only | Soft Roll Made By Frog Legs | E2222 | \$ 213 |
| <input type="checkbox"/> " | <input type="checkbox"/> 1"OR <input type="checkbox"/> 1.5" | Hub Color: | Tread Color: | Soft Roll Made By Frog Legs | E2222 | \$ CFP |
| FORKS | | | | | | |
| <input type="checkbox"/> | Frog Leg Shields(4 pcs) Only for Frog Leg Forks | | | | | \$ 28 |
| <input type="checkbox"/> | STD Aluminum Forks with Suspension Springs Black Only | | | | | \$ STD |
| | Extra Options for Aluminum Forks <input type="checkbox"/> without Suspension Springs | | | | | E1015 \$ NCO |
| | <input type="checkbox"/> With Quick Release Axles | | | | | K0073 \$ 123 |
| <input type="checkbox"/> | Frog Leg Suspension Forks 1" Wide (For 3", 4" x 1" width Caster and 5" STD Caster, 5" lighted Caster) Not available with Quick Release Axle | | | | | \$ 552 |
| | *User's Weight | Color | <input type="checkbox"/> Anodized Black <input type="checkbox"/> Anodized Silver | E1015 | | |
| <input type="checkbox"/> | Frog Leg Suspension Forks 1.5" Wide (For 3", 4" x 1.5" width Caster and 5" x 1"& 5" x 1.5" Casters) Not available with Quick Release Axle | | | | | \$ 522 |
| | *User's Weight | Color | <input type="checkbox"/> Anodized Black <input type="checkbox"/> Anodized Silver | E1015 | | |

Valid from 2022 Prices & Specifications Are Subject To Change Without Notice.

F WHEELS

| WHEELS | | | | | | | | | | | | | | | | | | | |
|---|--|---|---|------------|-------------|--------|--------|--|--|-------|---------|--|--|-----------|--|---|---|--|--------------------------|
| Wire Wheels | <input type="checkbox"/> 24" (540) <input type="checkbox"/> 25" (599) <input type="checkbox"/> 26" (590) | | \$ NCO \$ 299 \$ 299 | | | | | | | | | | | | | | | | |
| Y-360 Billet Wheels *Max. Capacity 220Lbs *Camber 0-2" max *Not for Sports or Rugged use | <input type="checkbox"/> 25" (559) Style <input type="checkbox"/> Saw Blade | | \$ 1,300 | | | | | | | | | | | | | | | | |
| Y-360 Billet Wheels MOD Style *Max. Capacity 220Lbs *Camber 0-2" max *Not for Sports or Rugged use | <input type="checkbox"/> 25" (559) Only Style <input type="checkbox"/> Tribal Sun <input type="checkbox"/> Girls <input type="checkbox"/> Eagle <input type="checkbox"/> Holy Cross <input type="checkbox"/> Hono(Flames) Specify Powder Coat Color for Insert Only () *Choose from Frame Colors | | \$ 1,550 | | | | | | | | | | | | | | | | |
| Extra Options for <input type="checkbox"/> Powder-Coated Spokes Only () *Choose from Frame Colors (\$250 up charge) | | | | | | | | | | | | | | | | | | | |
| Spinergy Spox 18 Spokes  | <input type="checkbox"/> 24" (540) <input type="checkbox"/> 25" (559) <input type="checkbox"/> 26" (590) Spoke Color <input type="checkbox"/> Black <input type="checkbox"/> Red <input type="checkbox"/> Yellow <input type="checkbox"/> Blue <input type="checkbox"/> White With Silver Hub With Black Hub With Black Hub With Black Hub With Black Hub <input type="checkbox"/> Custom Color Spoke Pattern <table border="1" style="display: inline-table; margin-left: 10px;"> <thead> <tr> <th colspan="2"></th> <th>Left Wheel</th> <th>Right Wheel</th> </tr> </thead> <tbody> <tr> <td>Spokes</td> <td>Inside</td> <td></td> <td></td> </tr> <tr> <td>Color</td> <td>Outside</td> <td></td> <td></td> </tr> <tr> <td>Hub Color</td> <td></td> <td><input type="checkbox"/> Black/<input type="checkbox"/> Silver</td> <td><input type="checkbox"/> Black/<input type="checkbox"/> Silver</td> </tr> </tbody> </table> | | | Left Wheel | Right Wheel | Spokes | Inside | | | Color | Outside | | | Hub Color | | <input type="checkbox"/> Black/ <input type="checkbox"/> Silver | <input type="checkbox"/> Black/ <input type="checkbox"/> Silver | | \$ 907 \$ 1,007 |
| | | Left Wheel | Right Wheel | | | | | | | | | | | | | | | | |
| Spokes | Inside | | | | | | | | | | | | | | | | | | |
| Color | Outside | | | | | | | | | | | | | | | | | | |
| Hub Color | | <input type="checkbox"/> Black/ <input type="checkbox"/> Silver | <input type="checkbox"/> Black/ <input type="checkbox"/> Silver | | | | | | | | | | | | | | | | |
| Spinergy LX 12 Spokes  | <input type="checkbox"/> 24" (540) <input type="checkbox"/> 25" (559) <input type="checkbox"/> 26" (590) Spoke Color <input type="checkbox"/> Black <input type="checkbox"/> Red <input type="checkbox"/> Yellow <input type="checkbox"/> Blue With Silver Hub With Black Hub With Black Hub With Black Hub <input type="checkbox"/> White <input type="checkbox"/> Neon Green <input type="checkbox"/> Pink <input type="checkbox"/> Orange With Black Hub With Black Hub With Black Hub With Black Hub <input type="checkbox"/> Purple With Black Hub | | \$ 1,138 \$ 1,238 | | | | | | | | | | | | | | | | |
| Spinergy X-Laced Sport Lite Extreme "XSLX" 24 Spokes  | <input type="checkbox"/> 24" (540) <input type="checkbox"/> 25" (559) <input type="checkbox"/> 26" (590) Spoke Color <input type="checkbox"/> Black <input type="checkbox"/> Red <input type="checkbox"/> Yellow <input type="checkbox"/> Blue With Silver Hub With Black Hub With Black Hub With Black Hub <input type="checkbox"/> White <input type="checkbox"/> Neon Green <input type="checkbox"/> Pink <input type="checkbox"/> Orange <input type="checkbox"/> Purple With Black Hub With Black Hub With Black Hub With Black Hub With Black Hub <input type="checkbox"/> Custom Color Spoke Pattern <table border="1" style="display: inline-table; margin-left: 10px;"> <thead> <tr> <th colspan="2"></th> <th>Left Wheel</th> <th>Right Wheel</th> </tr> </thead> <tbody> <tr> <td>Spokes</td> <td>Inside</td> <td></td> <td></td> </tr> <tr> <td>Color</td> <td>Outside</td> <td></td> <td></td> </tr> <tr> <td>Hub Color</td> <td></td> <td><input type="checkbox"/> Black/<input type="checkbox"/> Silver</td> <td><input type="checkbox"/> Black/<input type="checkbox"/> Silver</td> </tr> </tbody> </table> | | | Left Wheel | Right Wheel | Spokes | Inside | | | Color | Outside | | | Hub Color | | <input type="checkbox"/> Black/ <input type="checkbox"/> Silver | <input type="checkbox"/> Black/ <input type="checkbox"/> Silver | | \$ 1,100 \$ 1,200 |
| | | Left Wheel | Right Wheel | | | | | | | | | | | | | | | | |
| Spokes | Inside | | | | | | | | | | | | | | | | | | |
| Color | Outside | | | | | | | | | | | | | | | | | | |
| Hub Color | | <input type="checkbox"/> Black/ <input type="checkbox"/> Silver | <input type="checkbox"/> Black/ <input type="checkbox"/> Silver | | | | | | | | | | | | | | | | |

Valid from 2022 Prices & Specifications Are Subject To Change Without Notice.

Spinergy Sport Lite Extreme "SLX" 24 Spoke



24" (540) 25" (559) 26" (590)
 Spoke Color Black Red Yellow Blue
 With Silver Hub With Black Hub With Black Hub With Black Hub
 White Neon Green Pink Orange Purple
 With Black Hub With Black Hub With Black Hub With Black Hub With Black Hub

Custom Color Spoke Pattern

| | | Left Wheel | Right Wheel |
|-----------|---------|---|---|
| Spokes | Inside | | |
| | Outside | | |
| Hub Color | | <input type="checkbox"/> Black/ <input type="checkbox"/> Silver | <input type="checkbox"/> Black/ <input type="checkbox"/> Silver |

\$ 1,060

\$ 1,160

Spinergy Lite Extreme "XLX" X-Laced-12 Spoke



24" (540) 25" (559) 26" (590)
 Spoke Color Black Red Yellow Blue
 With Silver Hub With Black Hub With Black Hub With Black Hub
 White Neon Green Pink Orange Purple
 With Black Hub With Black Hub With Black Hub With Black Hub With Black Hub

Custom Color Spoke Pattern

| | | Left Wheel | Right Wheel |
|-----------|---------|---|---|
| Spokes | Inside | | |
| | Outside | | |
| Hub Color | | <input type="checkbox"/> Black/ <input type="checkbox"/> Silver | <input type="checkbox"/> Black/ <input type="checkbox"/> Silver |

\$ 1,100

\$ 1,200

Spinergy Blade "LXL" 18 Spoke



24" (540) 25" (559) 26" (590)
 Spoke Color Black Red Yellow Blue
 With Silver Hub With Black Hub With Black Hub With Black Hub
 White Neon Green Pink Orange Purple
 With Black Hub With Black Hub With Black Hub With Black Hub With Black Hub

Custom Color Spoke Pattern

| | | Left Wheel | Right Wheel |
|-----------|---------|--------------------------------|--------------------------------|
| Spokes | Inside | | |
| | Outside | | |
| Hub Color | | <input type="checkbox"/> Black | <input type="checkbox"/> Black |

\$ 945

\$ 1,045

HANDRIM

| | | |
|-------------|--|--------|
| Type | <input type="checkbox"/> Standard For 24", 25" or 26" Wheel Anodized Black | \$ STD |
| | <input type="checkbox"/> Vinyl Coated For 24", 25" & 26" Wheels Not available with Y-360 Billet Wheels | \$ 180 |
| | <input type="checkbox"/> Spinergy Silver Brushed Anodized For 24", 25" & 26" | \$ 160 |
| | <input type="checkbox"/> Natural Fit For 24", 25" & 26" Wheel | |
| | <input type="checkbox"/> Standard Grip (Not available with short tabs.) Not available with Y-360 Billet Wheels | \$ 495 |
| | <input type="checkbox"/> Super Grip (Not available with short tabs.) Not available with Y-360 Billet Wheels | \$ 561 |
| | <input type="checkbox"/> Without Thumb Grip (Not available with Y-360 Billet Wheels) | \$ 294 |
| | <input type="checkbox"/> Natural Fit(LT) For 24", 25" & 26" Wheel | |
| | <input type="checkbox"/> Standard Grip (Not available with short tabs.) Not available with Y-360 Billet Wheels | \$ 547 |
| | <input type="checkbox"/> Super Grip (Not available with short tabs.) Not available with Y-360 Billet Wheels | \$ 614 |
| | <input type="checkbox"/> Without Thumb Grip (Not available with Y-360 Billet Wheels) | \$ 347 |
| | <input type="checkbox"/> The Surge Handrims * Not available with Y-360 Billet Wheels | \$ 481 |
| | <input type="checkbox"/> The Surge Handrims (LT) * Not available with Y-360 Billet Wheels | \$ 524 |
| | <input type="checkbox"/> Spinergy Flex Rim Available only on Spinergy LX & XLX | \$ CFP |
| | <input type="checkbox"/> The Q-Grip Handrims : anti-slip, latex-free, neoprene coating * Not available with Y-360 Billet Wheels | \$ 472 |
| | <input type="checkbox"/> OMIT HANDRIMS | \$ NCO |

| | | |
|-------------------|---|--------|
| TAB LENGTH | <input type="checkbox"/> Long Tab (STD inside clearance 3/4") Not available with Y-360 Billet Wheels * | STD |
| | <input type="checkbox"/> Short Tab (Inside clearance 1/2") * Not available with Natural Fit Handrim with thumb grip | \$ STD |
| | <input type="checkbox"/> Short Tab (Set closest to wheel cut off excess) * Not available with Y-360 wheel | \$ 30 |

G CHAIR OPTIONS 1 / 3

| SEAT CUSHION | | | | | | | |
|--|---|---|--|------------------------------------|---|------------------------------------|------------------------------------|
| SUPRACOR® WHEELCHAIR CUSHIONS | | | | | | | |
| Stimulite® Contoured Cushion *Black Upholstery only *Comes with Zipper Pouch <input type="checkbox"/> Extra Sensitive (\$35 up charge) <input type="checkbox"/> Sling Style Bottom (\$52 up charge) <input type="checkbox"/> Custom Size (\$- CFP) W(") x D(") <input type="checkbox"/> Extra Cover (\$104 up charge) | <input type="checkbox"/> W14"xD16" (CD1416) | | E2603 | \$ 615 | | | |
| | <input type="checkbox"/> W16"xD16" (CD1616) | | E2603 | \$ 615 | | | |
| | <input type="checkbox"/> W16"xD18" (CD1618) | | E2603 | \$ 615 | | | |
| | <input type="checkbox"/> W18"xD16" (CD1816) | | E2603 | \$ 615 | | | |
| | <input type="checkbox"/> W18"xD18" (CD1818) | | E2603 | \$ 615 | | | |
| | <input type="checkbox"/> W18"xD20" (CD1820) | | E2603 | \$ 621 | | | |
| | <input type="checkbox"/> W20"xD16" (CD2016) | | E2603 | \$ 621 | | | |
| | <input type="checkbox"/> W20"xD18" (CD2018) | | E2603 | \$ 621 | | | |
| | <input type="checkbox"/> W20"xD20" (CD2020) | | E2603 | \$ 638 | | | |
| | Stimulite® Slimline Cushion *Black Upholstery only <input type="checkbox"/> Extra Sensitive (\$35 up charge) <input type="checkbox"/> Sling Style Bottom (\$52 up charge) <input type="checkbox"/> Custom Size (\$- CFP) W(") x D(") <input type="checkbox"/> Extra Cover (\$75 up charge) | <input type="checkbox"/> W14"xD16" (SM1416) | | E2603 | \$ 388 | | |
| <input type="checkbox"/> W16"xD16" (SM1616) | | | E2603 | \$ 388 | | | |
| <input type="checkbox"/> W16"xD18" (SM1618) | | | E2603 | \$ 388 | | | |
| <input type="checkbox"/> W18"xD18" (SM1818) | | | E2603 | \$ 388 | | | |
| <input type="checkbox"/> W18"xD20" (SM1820) | | | E2603 | \$ 426 | | | |
| <input type="checkbox"/> W20"xD16" (SM2016) | | | E2603 | \$ 426 | | | |
| <input type="checkbox"/> W20"xD18" (SM2018) | | | E2603 | \$ 426 | | | |
| <input type="checkbox"/> W20"xD20" (SM2020) | | | E2603 | \$ 450 | | | |
| Stimulite® Corbee Pediatric *Black Upholstery only <input type="checkbox"/> Extra Cover (\$75 up charge) | <input type="checkbox"/> W10"xD10" (PD1010) | | E2603 | \$ 258 | | | |
| | <input type="checkbox"/> W12"xD12" (PD1212) | | E2603 | \$ 258 | | | |
| | <input type="checkbox"/> W14"xD14" (PD1414) | | E2603 | \$ 258 | | | |
| | | | <input type="checkbox"/> Extra Sensitive (\$35 up charge) <input type="checkbox"/> Sling Style Bottom (\$52 up charge) <input type="checkbox"/> Custom Size W(") x D(") (\$- CFP) | | | | |
| ROHO WHEELCHAIR CUSHIONS | | | | | | | |
| Choose Size | <input type="checkbox"/> 4" HIGH PROFILE® QUADTRO SELECT® CUSHION *Black Upholstery <input type="checkbox"/> Extra Cover (\$+57) only | | | E2622-2623 | \$ 582 | | |
| | <input type="checkbox"/> W12"xD12" | <input type="checkbox"/> W12"xD13" | <input type="checkbox"/> W13"xD13" | <input type="checkbox"/> W13"xD15" | <input type="checkbox"/> W13"xD16" | <input type="checkbox"/> W15"xD13" | <input type="checkbox"/> W15"xD15" |
| | <input type="checkbox"/> W15"xD16" | <input type="checkbox"/> W15"xD18" | <input type="checkbox"/> W16"xD15" | <input type="checkbox"/> W16"xD16" | <input type="checkbox"/> W16"xD18" | <input type="checkbox"/> W16"xD20" | <input type="checkbox"/> W18"xD15" |
| | <input type="checkbox"/> W18"xD16" | <input type="checkbox"/> W18"xD18" | <input type="checkbox"/> W18"xD20" | <input type="checkbox"/> W18"xD22" | <input type="checkbox"/> W20"xD16" | <input type="checkbox"/> W20"xD18" | <input type="checkbox"/> W20"xD20" |
| | <input type="checkbox"/> W20"xD22" | <input type="checkbox"/> W22"xD18" | <input type="checkbox"/> W22"xD20" | <input type="checkbox"/> W22"xD22" | <input type="checkbox"/> Custom Size W(") x D(") (\$+CFP) | | |
| Choose Size | <input type="checkbox"/> 3" MID PROFILE® QUADTRO SELECT® CUSHION *Black Upholstery only <input type="checkbox"/> Extra Cover | | | E2622-2623 | \$ 582 | | |
| | <input type="checkbox"/> W15"xD15" | <input type="checkbox"/> W15"xD16" | <input type="checkbox"/> W16"xD16" | <input type="checkbox"/> W16"xD18" | <input type="checkbox"/> W18"xD16" | <input type="checkbox"/> W18"xD18" | |
| | <input type="checkbox"/> Custom Size W(") x D(") (\$+CFP) | | | | | | |
| Choose Size | <input type="checkbox"/> 2" LOW PROFILE® QUADTRO SELECT® CUSHION *Black Upholstery only <input type="checkbox"/> Extra Cover (\$+57) | | | E2622-2623 | \$ 582 | | |
| | <input type="checkbox"/> W12"xD12" | <input type="checkbox"/> W12"xD13" | <input type="checkbox"/> W13"xD13" | <input type="checkbox"/> W13"xD15" | <input type="checkbox"/> W13"xD16" | <input type="checkbox"/> W15"xD13" | <input type="checkbox"/> W15"xD15" |
| | <input type="checkbox"/> W15"xD16" | <input type="checkbox"/> W15"xD18" | <input type="checkbox"/> W16"xD15" | <input type="checkbox"/> W16"xD16" | <input type="checkbox"/> W16"xD18" | <input type="checkbox"/> W16"xD20" | <input type="checkbox"/> W18"xD15" |
| | <input type="checkbox"/> W18"xD16" | <input type="checkbox"/> W18"xD18" | <input type="checkbox"/> W18"xD20" | <input type="checkbox"/> W20"xD16" | <input type="checkbox"/> W20"xD18" | <input type="checkbox"/> W20"xD20" | |
| | <input type="checkbox"/> Custom Size W(") x D(") (\$+CFP) | | | | | | |
| STAR CUSHIONS | | | | | | | |
| Galaxy Cushion *Black Upholstery only <input type="checkbox"/> W14"xD14" (GXY 1414-2) <input type="checkbox"/> W14"xD16" (GXY 1416-2) <input type="checkbox"/> W16"xD14" (GXY 1614-2) <input type="checkbox"/> W16"xD16" (GXY 1616-2) <input type="checkbox"/> W16"xD18" (GXY 1618-2) <input type="checkbox"/> W18"xD16" (GXY 1816-2) ➔ <input type="checkbox"/> W18"xD18" (GXY 1818-2) <input type="checkbox"/> W18"xD20" (GXY 1820-2) <input type="checkbox"/> W20"xD16" (GXY 2016-2) <input type="checkbox"/> W20"xD18" (GXY 2018-2) <input type="checkbox"/> W20"xD20" (GXY 2020-2) | | | Choose Zoning Options <input type="checkbox"/> Standard - Dual Valve <input type="checkbox"/> Dual Valve - Front to Back <input type="checkbox"/> Four Valve <input type="checkbox"/> Simple - Single Valve <input type="checkbox"/> Four Valve - Enhanced <input type="checkbox"/> Four Valve - Front to Back | E2624 | \$ CFP | | |
| THE CURVE CUSHION *Black Upholstery only <input type="checkbox"/> Extra Cover (\$+ 40) | <input type="checkbox"/> W10"xD10" | <input type="checkbox"/> W10"xD11" | <input type="checkbox"/> W10"xD11" | <input type="checkbox"/> W10"xD12" | <input type="checkbox"/> W11"xD12" | <input type="checkbox"/> W12"xD12" | |
| | <input type="checkbox"/> W12"xD13" | <input type="checkbox"/> W12"xD14" | <input type="checkbox"/> W13"xD11" | <input type="checkbox"/> W13"xD12" | <input type="checkbox"/> W13"xD13" | <input type="checkbox"/> W13"xD14" | |
| | <input type="checkbox"/> W14"xD14" | <input type="checkbox"/> W14"xD15" | <input type="checkbox"/> W14"xD16" | <input type="checkbox"/> W15"xD14" | <input type="checkbox"/> W15"xD15" | <input type="checkbox"/> W15"xD16" | |
| | <input type="checkbox"/> W16"xD14" | <input type="checkbox"/> W16"xD15" | <input type="checkbox"/> W16"xD16" | <input type="checkbox"/> W16"xD17" | <input type="checkbox"/> W16"xD18" | <input type="checkbox"/> W17"xD16" | |
| | <input type="checkbox"/> W17"xD17" | <input type="checkbox"/> W17"xD18" | <input type="checkbox"/> W18"xD16" | <input type="checkbox"/> W18"xD17" | <input type="checkbox"/> W18"xD18" | | |
| | | | | | | | |

G CHAIR OPTIONS 2 / 3

| SEAT CUSHION | | | |
|---|--|---|--------------|
| Exgel Kaji Cushion | | | |
| For Comfortable Sitting To Prevent Pressure Sores | | | |
| <input type="checkbox"/> Owl Regular(1.6" Thick) Incontinence Cover Only | <input type="checkbox"/> W14"xD16" | | E2603 \$ 362 |
| | <input type="checkbox"/> W15"xD16" | | E2603 \$ 362 |
| | <input type="checkbox"/> W16"xD16" | | E2603 \$ 362 |
| | <input type="checkbox"/> W18"xD16" | * No Custom Sizes | E2603 \$ 408 |
| <input type="checkbox"/> Owl High(3.1" Thick) Incontinence Cover Only | <input type="checkbox"/> W14"xD16" | | E2603 \$ 437 |
| | <input type="checkbox"/> W15"xD16" | | E2603 \$ 437 |
| | <input type="checkbox"/> W16"xD16" | | E2603 \$ 437 |
| | <input type="checkbox"/> W18"xD16" | | E2603 \$ 495 |
| | <input type="checkbox"/> W18"xD18" | * No Custom Sizes | E2603 \$ 495 |
| <input type="checkbox"/> Owl Contour(4.3" Thick) Incontinence Cover Only | <input type="checkbox"/> W14"xD16" | | E2603 \$ 454 |
| | <input type="checkbox"/> W15"xD16" | | E2603 \$ 454 |
| | <input type="checkbox"/> W16"xD16" | | E2603 \$ 454 |
| | <input type="checkbox"/> W18"xD16" | | E2603 \$ 495 |
| * No Custom Sizes | | | |
| <input type="checkbox"/> Owl Deep Contour(4.3" Thick) <input type="checkbox"/> W14"xD16" \$ 458 * No Custom Sizes- Incontinence Cover Only <input type="checkbox"/> W14"xD16" \$518 <input type="checkbox"/> W15"xD16" \$518 <input type="checkbox"/> W16"xD16" \$518 <input type="checkbox"/> W18"xD16" \$558 | | | |
| <input type="checkbox"/> Standard Regular(1.4" Thick) Easy to Use Flat Style (superior pressure redistribution) For Pressure E2622-2623 <input type="checkbox"/> W12" x D12" \$368 <input type="checkbox"/> W13" x D13" \$368 <input type="checkbox"/> W14" x D14" \$368 <input type="checkbox"/> W14" x D16" \$368 <input type="checkbox"/> W16" x D16" \$368 <input type="checkbox"/> W16" x D17" \$368 <input type="checkbox"/> W17" x D16" \$368 <input type="checkbox"/> W17" x D17" \$368 <input type="checkbox"/> W18" x D16" \$391 <input type="checkbox"/> W18" x D18" \$391 <input type="checkbox"/> W18" x D19" \$440 <input type="checkbox"/> W18" x D20" \$440 <input type="checkbox"/> W19" x D19" \$440 | | | |
| * No Custom Sizes- Incontinence Cover Only | | | |
| <input type="checkbox"/> Standard High(2.6" Thick) Incontinence Cover Only E2622 *Black Upholstery only | | | |
| <input type="checkbox"/> W12" x D12" \$383 <input type="checkbox"/> W13" x D13" \$ 383 <input type="checkbox"/> W14" x D14" \$383 <input type="checkbox"/> W14" x D16" \$ 383 <input type="checkbox"/> W16" x D16" \$383 <input type="checkbox"/> W16" x D17" \$383 <input type="checkbox"/> W17" x D16" \$383 <input type="checkbox"/> W17" x D17" \$383 <input type="checkbox"/> W18" x D16" \$460 <input type="checkbox"/> W18" x D18" \$460 <input type="checkbox"/> W18" x D19" \$512 <input type="checkbox"/> W18" x D20" \$512 <input type="checkbox"/> W19" x D19" \$512 <input type="checkbox"/> W18" x D19" \$512 | | | |
| <input type="checkbox"/> Standard Anti-Thrust(2.6" Thick) * No Custom Sizes Incontinence Cover Only | <input type="checkbox"/> W16 x D16 \$460 <input type="checkbox"/> W18 x D16 \$500 <input type="checkbox"/> W18 x D18 \$500 | Prevents Unwanted Forward Movement of lower back and hip bone | |
| <input type="checkbox"/> Lite Regular(2.2" Thick) <input type="checkbox"/> W16" x D16" \$374 <input type="checkbox"/> W18" x D16" \$397 <input type="checkbox"/> W18" x D18" \$397 * No Custom Sizes- Incontinence Cover Only | | | |
| <input type="checkbox"/> Lite High(3.0" Thick) <input type="checkbox"/> W16" x D16" \$408 <input type="checkbox"/> W18" x D16" \$431 <input type="checkbox"/> W18" x D18" \$431 * No Custom Sizes- Incontinence Cover Only | | | |

H CHAIR OPTIONS 3 / 3

POSITIONING BACK

***Note : Actual height of the backrest will increase 2" or more.**

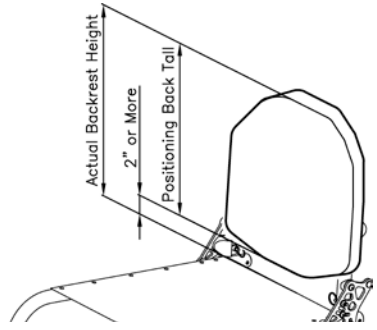

ADI CARBON BACKREST (Support Contour-ACTIVE 2.5") *Not Available with Welded Side Guards

| | | | | |
|--|---|---------------|--------------|---------|
| Mounting Hardware: | <input type="checkbox"/> 2 Point Pro <input type="checkbox"/> Quick Release | | | |
| Height | <input type="checkbox"/> LOW (10" Tall) *Backrest Height requires 12" or more *Available 13"-19" width | Width (") | E2613 | \$ 857 |
| | <input type="checkbox"/> Medium (13" Tall) *Backrest Height requires 15" or more *Available 13"-19" width | Width (") | E2613 | \$ 937 |
| | <input type="checkbox"/> Standard (16" Tall) *Backrest Height requires 18" or more *Available 13"-19" width | Width (") | E2613 | \$1,012 |
| | <input type="checkbox"/> Custom Size (" Tall) x (" width) | | E2613 | \$ CFP |
| <input type="checkbox"/> Add Privacy Flap (\$69 up charge) | | | | |

ADI ALUMINUM BACKREST (Support Contour-ACTIVE 2.5") *Not Available with Welded Side Guards

| | | | | |
|--|---|---------------|--------------|--------|
| Mounting Hardware: | <input type="checkbox"/> 2 Point Pro <input type="checkbox"/> Quick Release | | | |
| Height | <input type="checkbox"/> LOW (10" Tall) *Backrest Height requires 12" or more *Available 10"-20" width | Width (") | E2613 | \$ 702 |
| | <input type="checkbox"/> Medium (13" Tall) *Backrest Height requires 15" or more *Available 12"-20" width | Width (") | E2613 | \$ 719 |
| | <input type="checkbox"/> Standard (16" Tall) *Backrest Height requires 18" or more *Available 14"-20" width | Width (") | E2613 | \$ 736 |
| | <input type="checkbox"/> Tall (18" Tall) *Backrest Height requires 20" or more *Available 16"-20" width | Width (") | E2613 | \$ 753 |
| | <input type="checkbox"/> X-Tall (20" Tall) *Backrest Height requires 22" or more *Available 16"-20" width | Width (") | E2613 | \$ 570 |
| <input type="checkbox"/> Add Privacy Flap (\$69 up charge) | <input type="checkbox"/> Custom Size (" Tall) x (" width) | | E2613 | \$ CFP |

ADI ALUMINUM BACKREST (Support Contour-DEEP 4") *Not Available with Welded Side Guards*Not Available with Lateral Supports

| | | | | |
|--|---|---------------|--------------|--------|
| Mounting Hardware: | <input type="checkbox"/> 2 Point Pro <input type="checkbox"/> Quick Release | | | |
| Height | <input type="checkbox"/> LOW (10" Tall) *Backrest Height requires 12" or more *Available 10"-20" width | Width (") | E2615 | \$ 817 |
| | <input type="checkbox"/> Medium (13" Tall) *Backrest Height requires 15" or more *Available 12"-20" width | Width (") | E2615 | \$ 834 |
| | <input type="checkbox"/> Standard (16" Tall) *Backrest Height requires 18" or more *Available 14"-20" width | Width (") | E2615 | \$ 851 |
| | <input type="checkbox"/> Tall (18" Tall) *Backrest Height requires 20" or more *Available 16"-20" width | Width (") | E2615 | \$ 868 |
| | <input type="checkbox"/> X-Tall (20" Tall) *Backrest Height requires 22" or more *Available 16"-20" width | Width (") | E2615 | \$ 886 |
| <input type="checkbox"/> Add Privacy Flap (\$69 up charge) | <input type="checkbox"/> Custom Size (" Tall) x (" width) | | E2615 | \$ CFP |

ADI LATERAL SUPPORTS (Lateral Supports are compatible with only active 2.5" ADI positioning back.)

| | | | |
|---|--|--|--------|
| <input type="checkbox"/> Stationary Pad | Pad Size <input type="checkbox"/> Small (3" H x 3" D) <input type="checkbox"/> Medium(3" H x 4" D) <input type="checkbox"/> Large(4.5" H x 4.5" D) <input type="checkbox"/> Large(4" H x 6" D) | | |
| | <input type="checkbox"/> Pair | | \$ 368 |
| | <input type="checkbox"/> Left side only or <input type="checkbox"/> Right side only | | \$ 184 |
| <input type="checkbox"/> Swing-Out | Pad Size <input type="checkbox"/> Small (3" H x 3" D) <input type="checkbox"/> Medium(3" H x 4" D) <input type="checkbox"/> Large(4.5" H x 4.5" D) <input type="checkbox"/> Large(4" H x 6" D) | | |
| | <input type="checkbox"/> Pair | | \$ 598 |
| | <input type="checkbox"/> Left side only or <input type="checkbox"/> Right side only | | \$ 299 |

OTHER

| | |
|--|--------|
| <input type="checkbox"/> ADI Transfer Board <input type="checkbox"/> 21" (ADV21) <input type="checkbox"/> 24" (ADV24) <input type="checkbox"/> 29" (ADV29) | \$ 71 |
| <input type="checkbox"/> ADI Push and Transfer Gloves Leather (one size fits) | \$ 69 |
| <input type="checkbox"/> ADI Carbon Solid Seat (Wide: 18" Max, Depth: 20") ✘ ONLY AVAILABLE WITH COLOURS NON-REMOVABLE SIDE GUARDS | \$ 719 |

VARILITE® Seating Systems Available Please visit for all options. www.varilite.com CFP

NOTE