



 SWISS MADE  
SWISS TECHNOLOGY

**SERIES 490**  
INDUSTRIAL SCALES



## PRECISA DNA: ZERO COMPROMISE

Laboratory and industrial technicians are aware of the significance of the results they provide. That is why they are unwilling to accept any compromise in their field of work. This is precisely why leading specialists around the world place their trust in Precisa and have done for decades.

## PRECISA DNA: SWISS PRECISION

Precisa products are prime examples of Swiss perfection and reliability. They are tried and tested in both demanding laboratory environments and industrial applications, and are subject to rigorous quality controls throughout the entire manufacturing process. Precisa invests continuously in developing new technologies and employs a highly qualified team. The result is a state-of-the-art range of precision instruments for the most exacting demands.

## PRECISA DNA: SERIES 490

The Precisa 490 Series range of industrial scales stands for utmost Swiss precision. Built for all areas of industrial weighing where high precision is required. Exceptional performance features and built-in automatic self calibration system gives users full confidence in achieving accurate weighing results – approved and certified.

The wide range of integrated applications makes the Series 490 first choice for every conceivable industrial weighing application. Ease-of-use included.

The finest electro-magnetic force restoration system, which conforms to the highest metrological standards, secure that all weighing results are absolutely reliable.



# TERMINALS

## PRECISA SERIES 490

### IBK Terminal

User-friendly indicator.

Standard keyboard layout with 10 keys. 4 freely definable function keys. Large digital display, 20 digit display information line. Vacuum fluorescent display. Weighing-in guide +/-

Applications included: weight unit switching, counting, percent weighing, net totals, check weighing, animal weighing, totalisation, statistics, calculation, area weight calculation, Multi-User Memory (MUM).

### ITK Terminal

User-friendly, multi-application indicator. A perfect solution for piece counting without removing goods from the box.

Additional keyboard for alphanumerical inputs for manual tare and reference weight input.

Vacuum fluorescent display. Weighing-in guide +/-  
Applications included: all the above applications included with Indicator IB plus Dynamic Differential Weighing (DDW), Minimum Sample Weight (MSW), density determination, Multi-level Backweighing (MBW).

### ISK Terminal

Multi-application indicator for special applications. Additional keyboard with 30 keys for alphanumerical inputs for manual tare and reference weight input. Vacuum fluorescent display. Weighing-in guide +/-  
All applications as per Indicator IT and additional SmartBox®.



IBK Terminal



ITK Terminal



ISK Terminal

# FEATURES

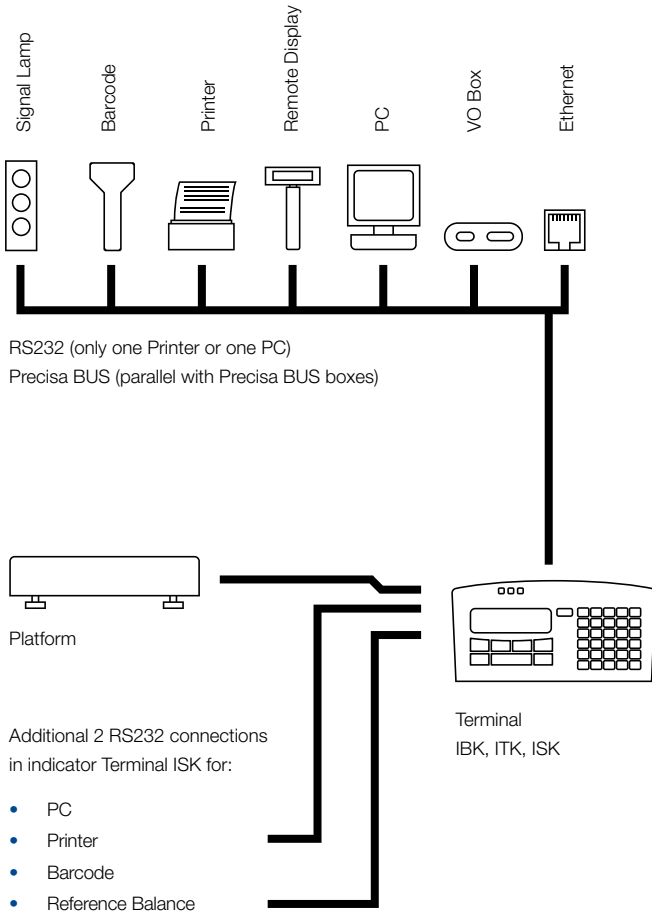

## PRECISA SERIES 490

### SCS (Self-Calibration System)

The 490 Series is equipped with a fully automatic time and temperature controlled internal calibration system (SCS).

The SCS can be set to provide regular calibration at predetermined times or temperature changes in accordance with ISO and GLP guidelines. Additionally external calibration can be achieved via the Intelligent Calibration Mode (ICM) with a choice of external weights.

### IP65 Protection

All the 490 Series are available with IP65 industrial protection as an option. IP65 protects against ingress of dust and water splashes. The balance is fitted with a protective keyboard.

### Versatile Connectivity

The standard interface can work as RS232 or as Precisa BUS.

RS232 for single connection of:

- Printer
- PC

Precisa BUS boxes for parallel connection of:

- Printer
- PC
- Signal Lamp
- Barcode scanner
- Remote display
- I/O Box
- Ethernet

The indicator Terminal ISK contains a Precisa BUS and 2 RS232 connections for:

- PC
- Printer
- Barcode scanner
- Reference balance
- Ethernet

# MODELS, OPTIONS AND ACCESSORIES

Model	Capacity	Readability	Repeatability	Linearity	Pan Size (mm)	Class / „e“	Response Time	Item No.
IBK 12000D	12 100 g	0.1 g	0.1 g	0.2 g	400 x 300	II / 1 g	2 s	490-9528-00x**
IBK 18000D	18 100 g	0.1 g	0.1 g	0.2 g	400 x 300	II / 1 g	2 s	490-9529-00x**
IBK 24000D	24 100 g	0.1 g	0.1 g	0.2 g	400 x 300	II / 1 g	2 s	490-9530-00x**
IBK 34000D	34 100 g	0.1 g	0.1 g	0.2 g	400 x 300	II / 1 g	2 s	490-9531-00x**
IBK 34000D-DR	1 2000 g / 3 4 100 g *	0.1 g / 1 g	0.1 g	0.2 g	400 x 300	II / 1 g	2 s	490-9805-00x**
IBK 34000D-FR	1 2000 g - 3 4 100 g *	0.1 g / 1 g	0.1 g	0.2 g	400 x 300	II / 1 g	2 s	490-9532-00x**
IBK 20000G	20 100 g	1 g	0.5 g	1 g	400 x 300	II / 1 g	2 s	490-9606-00x**
IBK 30000G	30 100 g	1 g	0.5 g	1 g	400 x 300	II / 1 g	2 s	490-9607-00x**
IBK 40000G	40 100 g	1 g	0.5 g	1 g	400 x 300	II / 2 g	2 s	490-9608-00x**
IBK 60000G	60 100 g	1 g	1 g	1.5 g	400 x 300	II / 10 g	2 s	490-9609-00x**

Dimensions (WxLxH) with terminal 400x465x150 mm

Dimensions (WxLxH) without terminal 400x300x150 mm

Terminal IBK as standard. Net weight 15 kg  
Protection platform IP54 (IP65 optional)

Options	Item No.
EU-Verification according to 2014/31/EU by Precisa (initial verification) available only for balances with EU/OIML type approval	350-8578
Protection IP65: protection against ingress of dust and low pressure water jets, fitted at factory	350-8646

Accessories	Item No.
Wall bracket for terminal	350-8654
Post for rear mounted terminal	350-8655
Connection cable terminal to platform, length 3m	350-8586-030
Connection cable terminal to platform, length 5.5m	350-8586-055
Connection cable terminal to platform, length 10m	350-8586-100
Below the balance weighing feature, up to 40kg	350-8630
Below the balance weighing feature, up to 40kg, IP65 version	350-8635
Protective cover 490 for terminal, set of 5 pieces	350-8599

Operating Temperature	Line Voltage, Tolerance	Power Consumption	Frequency
5 .. 40 °C (41°F .. 104°F)	115V / 230V, +15% / -20%	25 VA	50 - 60 Hz

\* Approved up to max. 30 100 g

\*\* -001 for Terminal IBK, -002 for Terminal ITK, -003 for Terminal ISK Count, -004 for Terminal ISK FPVO

# SPECIAL PRODUCTS ACCESSORIES



















Common Accessories	490 IBK/ITK/ISK
Printer LP4024, 230V / 115V	350-8391
Paper roll for Printer LP4024, set of 4 pieces	350-8392
Ribbon for Printer LP4024	PN 3953-013
Paper roll for Printer CBM910	350-8366
Ribbon for Printer CBM910	350-8367
Multiplexor for up to 7 instruments for serial (RS232) data transmission to PC or Printer (at least one instrument must be a series 320, 321, 330, 335, 365 or 490)	350-8513
Data cable RJ45, 0.75m	350-8525
Data cable RJ45, 1.5m	350-8520
Data cable RJ45, 3m	350-8521
Adapter RJ45-DB9f, (PC/Printer LP4024)	350-8522
Adapter RJ45-DB25m, (Printer CBM910)	350-8524
Data cable RJ45-DB9f, 1.5m, (PC/Printer LP4024)	350-8557
Data cable RJ45-DB25m, 1.5m, (Printer CBM910)	350-8559
Interface box, Interface and power splitter	350-8940-000
Interface box, LAN Ethernet connection	350-8940-001
Interface box, WiFi connection	350-8940-002
Interface box, Bluetooth connection	350-8940-003
HID cable, RS232, DB9m-USB-A, 1.5m, (PC), (x: 0=e, 1=d, 2=f)	350-8816-x00
External USV accu power pack for continuous operation	350-8662
Anti-theft device, mechanical	350-8555
Carat bowl (for diamond weighing)	350-8322















PrecisaBUS Accessories (available on demand only)	490 IBK/ITK/ISK
Remote display free-standing, incl. 1.5 m cable	350-8504
Remote display with wall bracket, incl. 1.5 m cable	350-8516
RS232 interface box for data transmission, DB25f: - to PC, Printer or Barcode-Printer - from Barcode-Reader (350-8856) or reference balance	350-8506
Interface 20mA current loop passive	350-8526
LAN Ethernet connection	350-8573
WiFi connection	350-8588
Signal Lamp, indicator with 3 lamps, green / red / yellow	350-8510
Horn for signal lamp	350-8533
Input / Output module with 6 TTL inputs / 8 relay outputs	350-8509
CCE-Barcode scanner BCS5040, DB25m, with push button, to be connected to Interface RS232 350-8506	350-8856

SmartBox® Applications	490 IBK/ITK/ISK
SmartBox® Counting	350-8511-011** (in ISK Count incl.)
SmartBox® FPVO (Finished Goods Packing Control)	350-8511-012** (in ISK FPVO incl.)
CCE-Barcode scanner BCS5040, RJ45, with push button to be connected to the SmartBox®	350-8531

\*\* In 490 ISK the corresponding SmartBox® application Counting or FPVO is built-in

# FEATURES & APPLICATIONS

Features	IBK	ITK	ISK
 Swiss Made	✓	✓	✓
 Vacuum fluorescent display	✓	✓	✓
 Self-calibration system, fully automated	✓	✓	✓
 Clock (GLP/GMP printout, auto-cal, etc.)	✓	✓	✓
 Precisa BUS	<b>OD</b>	<b>OD</b>	<b>OD</b>
 Support IQ/OQ/PQ	✓	✓	✓
 Below balance weighing	✓	✓	✓
 Anti-theft protection (mechanical and code)	✓	✓	✓
 Easy alphanumeric input			✓
 Direct tare and reference weight entry		✓	✓
 Identifier and label handling			✓
 RS232 interface (for PC/printer)	✓	✓	✓
 Human Interface Device (to PC)	<b>AC</b>	<b>AC</b>	<b>AC</b>
 LAN Ethernet connection	<b>AC</b>	<b>AC</b>	<b>AC</b>
 Wi-Fi connection	<b>AC</b>	<b>AC</b>	<b>AC</b>
 Bluetooth connection	<b>AC</b>	<b>AC</b>	<b>AC</b>
 External I/O (Tare, Print, ..., Realis)	<b>OD</b>	<b>OD</b>	<b>OD</b>
 EU/OIML type approval	✓	✓	✓

Applications	IBK	ITK	ISK
 Units g, mg, oz, lb, tael, etc.	✓	✓	✓
 Percent weighing	✓	✓	✓
 Piece counting	✓	✓	✓
 Animal weighing	✓	✓	✓
 Dynamic difference weighing		✓	✓
 Free conversion Area conversion	✓	✓	✓
 Check weighing	✓	✓	✓
 Net total application: Add up summation (Dosing program)	✓	✓	✓
 Statistics	✓	✓	✓
 Recorder	✓	✓	✓
 Density determination (of liquids, solids, ...)		✓	✓
 Multilevel back weighing		✓	✓
 Automatic repeatability test	✓	✓	✓
 Minimum sample weight (USP, Chapter 41)		✓	✓



# DIMENSIONS

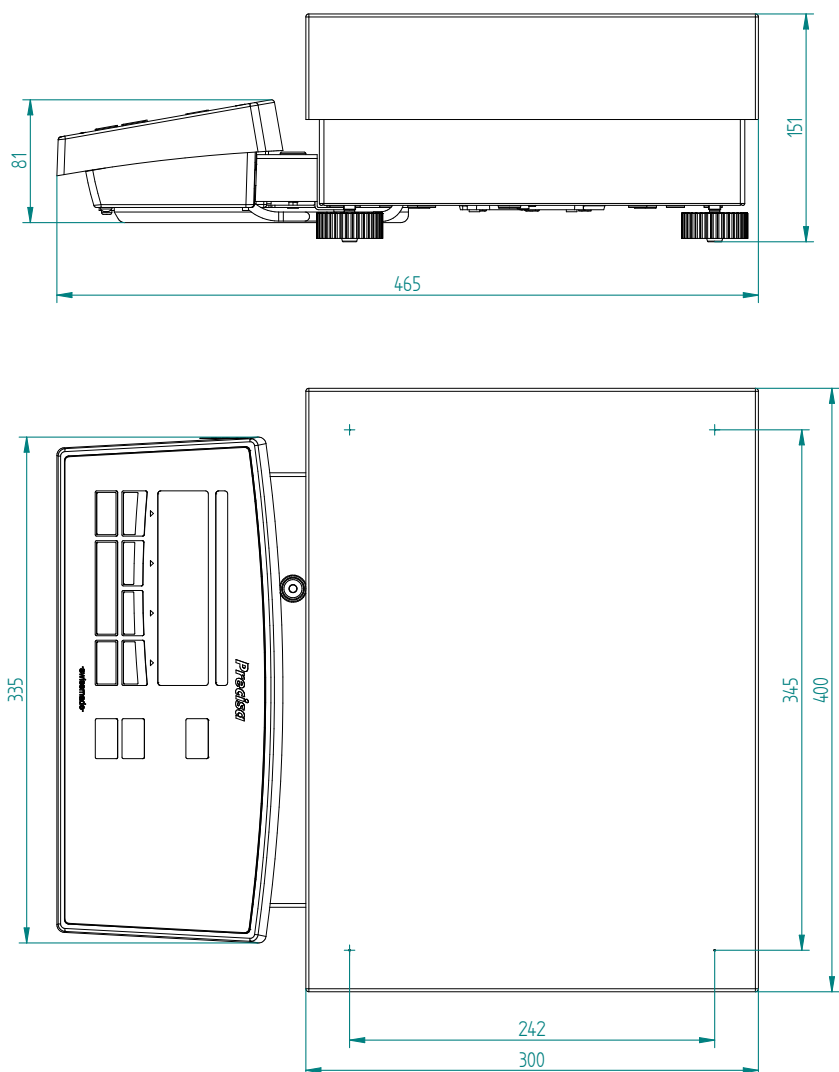

## TECHCOMP GROUP

In addition to Precisa, Techcomp Europe comprises of the following companies:



### Precisa Gravimetrics AG

Moosmattstrasse 32  
8953 Dietikon, Switzerland  
Tel. +41 44 744 28 28  
Fax +41 44 744 28 38  
Email: [info@precisa.ch](mailto:info@precisa.ch)  
[www.precisa.com](http://www.precisa.com)

ISO 9001:2015  
BUREAU VERITAS  
Certification

N° CH10355934

