

## **Precisa Balances Series 490 IB/IT/IS**

### *Operating Instructions*



## Declaration of conformity

**Declaration of conformity for apparatus with CE mark**  
**Konformitätserklärung für Geräte mit CE-Zeichen**  
**Déclaration de conformité pour appareils portant la marque CE**  
**Declaración de conformidad para aparatos con disitintivo CE**  
**Dichiarazione di cofnromitá per apparecchi contrassegnati con la marcatura CE**

- English** We hereby declare that the product to which this declaration refers conforms with the following standards.
- Deutsch** Wir erklären hiermit, dass das Produkt, auf das sich diese Erklärung bezieht, mit den nachstehenden Normen übereinstimmt.
- Français** Nous déclarons avec cela responsabilité que le produit, auquel se rapporte la présente déclaration, est conforme aux normes citées ci-après.
- Español** Manifestamos en la presente que el producto al que se refiere esta declaración est´´a de acuerdo con las normas siguientes
- Italiano** Dichiariamo con ciò che il prodotto al quale la presente dichiarazione si riferisce è conforme alle norme di seguito citate.

**Electronic Balance: Precisa Series 490 IBK**  
**Precisa Series 490 ITK**  
**Precisa Series 490 ISK**  
**Precisa Series 410**

Mark applied	EU Directive	Standards
	2014/30/EU 2014/35/EU	EN 61326 EN 61010

Date: 20.04.2016

Signature:



R. Grolimund R & D Manager

# Identification

## Customer service

Precisa Gravimetrics AG  
Moosmattstrasse 32  
CH-8953 Dietikon  
Tel. + 41-44-744 28 28  
Fax. + 41-44-744 28 38  
email [service@precisa.ch](mailto:service@precisa.ch)

<http://www.precisa.com>

Refer to our website for information about local customer service centers and details of their addresses.

## Copyright

These operating instructions are protected by copyright. All rights reserved. No part of the operating instructions may be reproduced, processed, duplicated or published in any form by photocopying, microfilming, reprinting or other process, in particular electronic means, without the written agreement of Precisa Gravimetrics AG.

© Precisa Gravimetrics AG, 8953 Dietikon, Switzerland, 2019

# 1 Overview

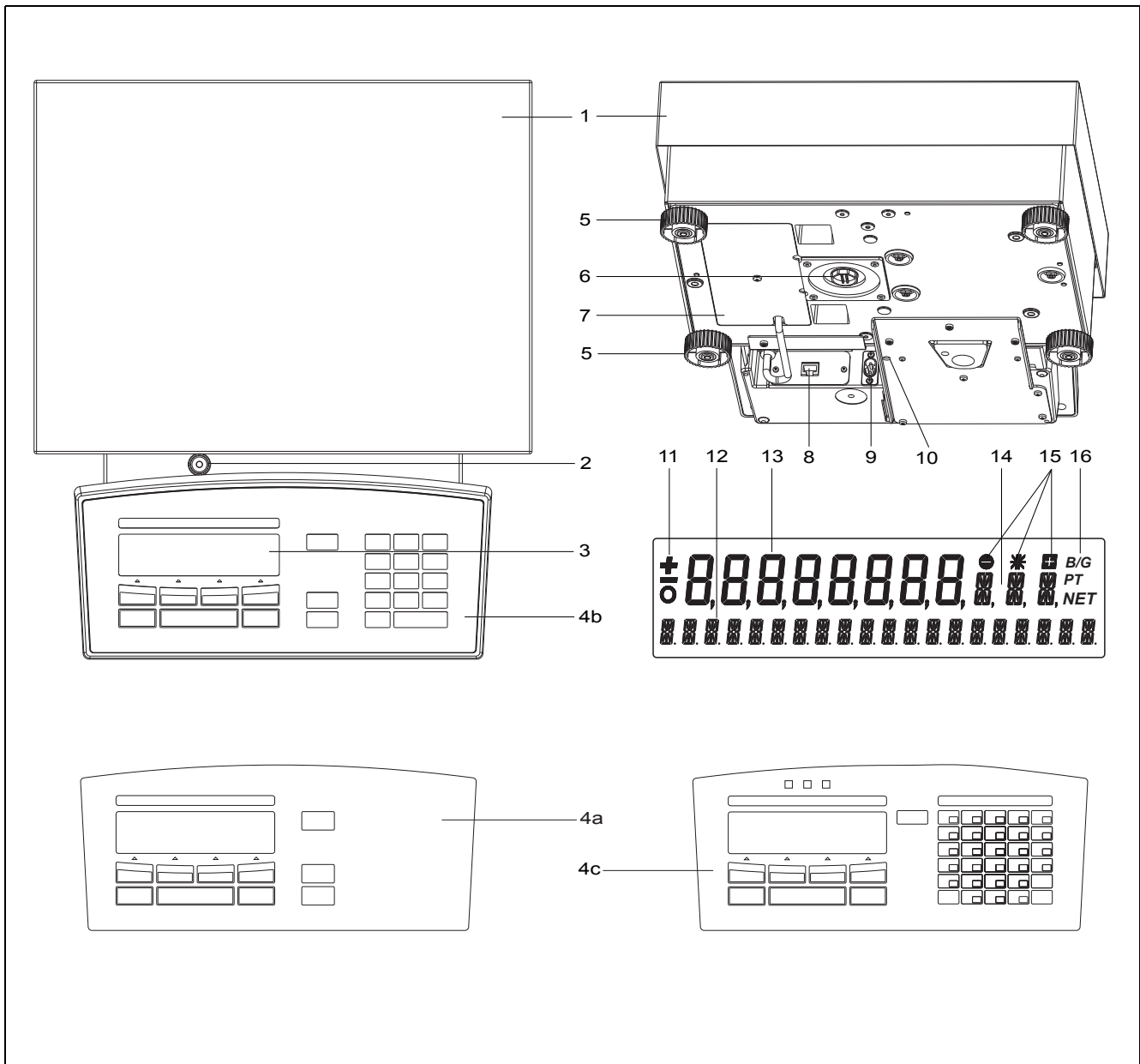

No.	Description	Section / Page	No.	Description	Section / Page
1	Weighing pan	2 / 4	8	Serial interface, RJ45 socket	13.1 / 34
2	Levelling bubble	7.6 / 11	9	Power connection socket	7.5 / 11
3	Display		10	Mechanical anti-theft protection	
4a	Control panel IB	8.1 / 13	11	Prefix display	7.9 / 12
4b	Control panel IT for: - text entry in menu with «text» - producname entry with «SHIFT name» - tare input entry with «nnn.n» - referenz weight entry with « * n.nnn» - reference pivce count entry with «. nn»	see also 8.3.4 / 16 9.2 / 23 9.3 / 24	12	Info display	

No.	Description	Section / Page	No.	Description	Section / Page
4c	Control panel IS for: - text entry in menu with «text» - working with the „Smart Application“ see in separate manual		13	Measurement display	
5	Adjustable feet	7.6 / 11	14	Unit display	8.3.3 / 15
6	Locking pin, below balance weighing	3 / 5	15	Weight check	11 / 31
7	Cable storage 1.5m		16	Symbol display	

## ■ 2 Inspection and assembly

# 2 Inspection and assembly

Inspect delivery for complete supply immediately on unpacking all components.

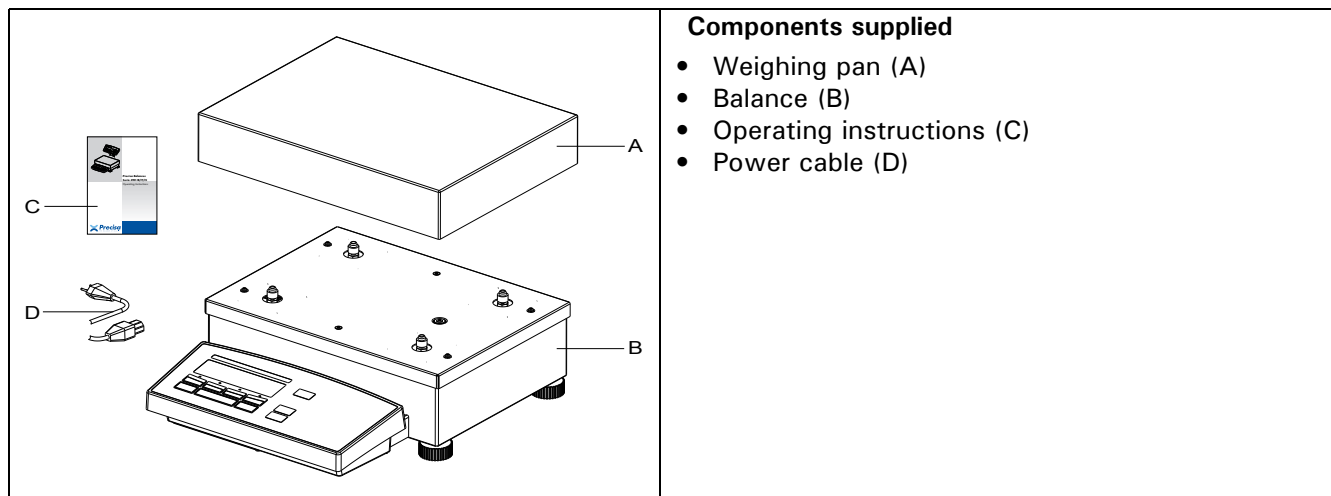

The balance is delivered in partly dismantled condition. Assemble the individual components in the following sequence:

- Place the weighing pan (A) in position
- Insert the power cable (D) into the socket at the rear of the balance(9).

### —— 3 NOTE

A screwdriver is required for assembly.

All parts must fit together easily. Do not apply force. Precisa Customer Service will be pleased to help you with any problems.

### 3 Below-balance weighing

Objects which, because of their size or shape, cannot be put on the scale, can be weighed by means of below-balance weighing.

The necessary parts are available as accessories (see chapter 4 "Accessories").

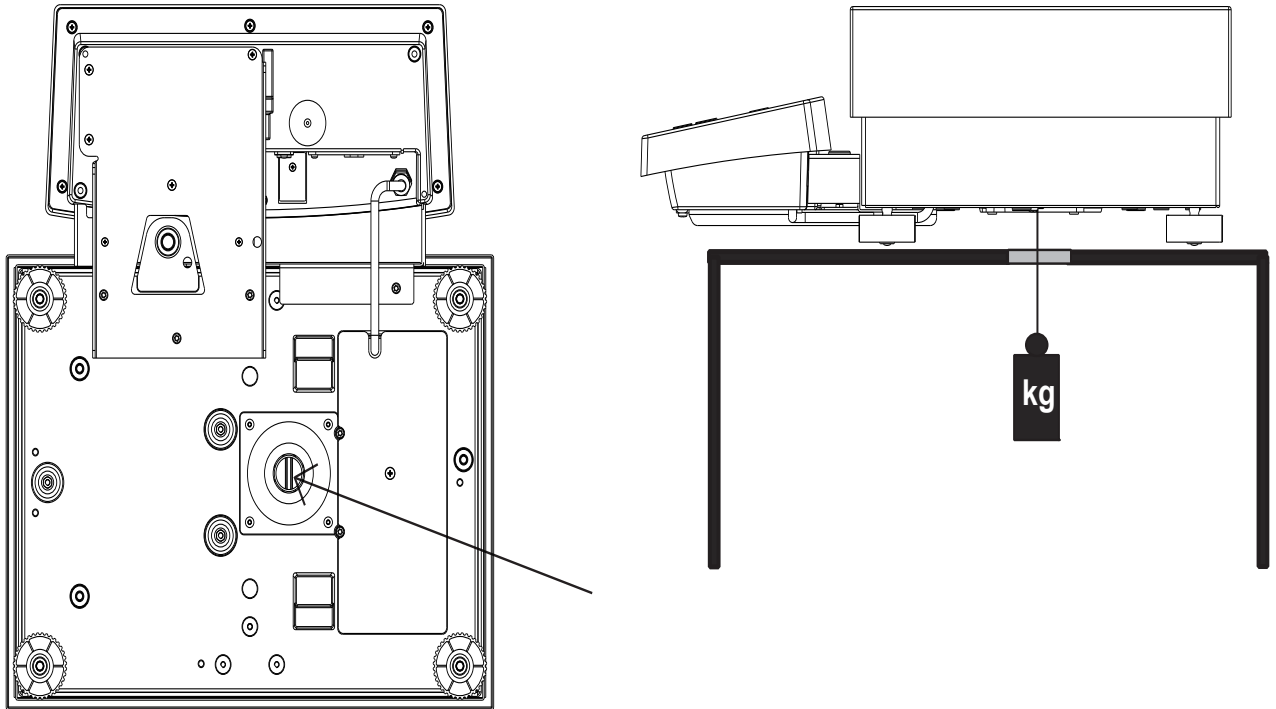

## 4 Accessories

Accessorie	Article number
Post for rear mounted display	350-8655
Wall bracket for display (Cable in terminal is 1.5m)	350-8654
Connection-cable indicator to platform, length 3m, 5.5m or 10m	350-8586-030, 350-8586-055, 350-8586-100
Second display, free-standing, Cable 1.5m	350-8504
Second display, wall-mounted, Cable 3m	350-8516
CCE-Bar code scanner to be connected to the smartbox	350-8531
CCE-Bar code scanner to be connected to Interface-Box RS232 (350-8506)	350-8856
HID (Humin Interface Device) für PC keyboard emulation in Englisch	350-8816-000
- German	350-8816-100
- French	350-8816-200
BUS Interface RS232	350-8506
BUS Interface 20 mA current loop passiv	350-8526
BUS Ethernet Interface	350-8573
Analog output -10 V... + 10 V (Resolution 10 mV)	350-8508
Input/Output module (6 TTL inputs, 8 Relay outputs)	350-8509
Signal-lamp with 3 bulbs (green, yellow, red)	350-8510
Horn for signal lamp	350-8533
Multiplexer for up to 7 balances (RS232)	350-8513
Datacable RJ45 - RJ45, 0.75 m	350-8525
Datacable RJ45 - RJ45, 1.5 m	350-8520
Datacable RJ45 - RJ45, 3 m	350-8521
Datacable RJ45 - DB9 female (PC), 1.5m	350-8557
Datacable RJ45 - DB25 male (Printer), 1.5m	350-8559
Cable for reference balance	350-8534
Below the balance weighing feature	350-8630
Below the balance weighing feature, IP65	350-8635
Dust cover for indicator, set of 5 pieces	350-8599
External USV accu power pack	350-8662
Anti-theft device	350-8555
EU conformity evaluation	350-8578



Identification.....	1	8.5.2	Selecting an application program .....	22
<b>1 Overview .....</b>	<b>2</b>	<b>9</b>	<b>Application.....</b>	<b>24</b>
<b>2 Inspection and assembly .....</b>	<b>4</b>	<b>9.1</b>	<b>Units .....</b>	<b>24</b>
<b>3 Below-balance weighing .....</b>	<b>5</b>	<b>9.2</b>	<b>Count .....</b>	<b>24</b>
<b>4 Accessories .....</b>	<b>6</b>	<b>9.3</b>	<b>Percent .....</b>	<b>27</b>
<b>5 Introduction .....</b>	<b>8</b>	<b>9.4</b>	<b>Calculator.....</b>	<b>28</b>
5.1 Useful tips on the Operating Instructions	8	<b>9.5</b>	<b>Paper.....</b>	<b>28</b>
<b>6 Safety .....</b>	<b>9</b>	<b>9.6</b>	<b>Net-Total.....</b>	<b>29</b>
6.1 Representations and symbols.....	9	<b>9.7</b>	<b>Sum .....</b>	<b>30</b>
6.2 Safety recommendations .....	9	<b>9.8</b>	<b>Animal .....</b>	<b>31</b>
<b>7 Set up .....</b>	<b>10</b>	<b>10</b>	<b>Statistics .....</b>	<b>32</b>
7.1 Unpacking the balance .....	10	<b>11</b>	<b>Check-Weighing.....</b>	<b>34</b>
7.2 Transport and shipping.....	10	<b>12</b>	<b>User profiles.....</b>	<b>35</b>
7.3 Storage .....	10	<b>12.1</b>	Activating a user.....	35
7.4 Choosing a suitable location .....	11	<b>12.2</b>	Creating a new user profile.....	35
7.5 Connecting the balance to the mains ..	11	<b>12.3</b>	Changing the password and password protection .....	36
7.6 Levelling .....	11	<b>12.4</b>	Clearing a user.....	36
7.7 Calibration of the balance .....	12	<b>12.5</b>	Setting the user .....	36
7.8 Dual Range and Floating Range balances	12	<b>13</b>	<b>Data transfer .....</b>	<b>37</b>
7.9 Standardized balance .....	12	<b>13.1</b>	Connection scheme .....	37
7.10 Switching on the balance .....	12	<b>13.2</b>	Remote control-commands .....	38
7.11 Auto-Standby Mode.....	12	<b>13.2.1</b>	Examples for the remote control.....	39
<b>8 Operation .....</b>	<b>13</b>	<b>14</b>	<b>Service .....</b>	<b>40</b>
8.1 Menu control operation principle.....	13	<b>14.1</b>	Maintenance and servicing .....	40
8.1.1 Operating in the Weighing mode .....	13	<b>14.2</b>	<b>Error messages .....</b>	<b>40</b>
8.1.2 Operation in the programming mode ...	14	<b>14.2.1</b>	Notes on correcting faults .....	40
8.2 Setting the factory configuration .....	14	<b>14.3</b>	<b>Calibration.....</b>	<b>41</b>
8.3 Device configuration .....	14	<b>14.3.1</b>	External calibration by means of ICM ..	41
8.3.1 Activating the configuration menu .....	15	<b>14.3.2</b>	External calibration with freely selectable weight .....	42
8.3.2 Language function.....	15	<b>14.3.3</b>	Internal calibration.....	42
8.3.3 Selecting the weight unit.....	15	<b>14.3.4</b>	Automatic calibration.....	42
8.3.4 Print functions .....	16	<b>14.4</b>	<b>Automatic Repeatability Test (ART) ....</b>	<b>43</b>
8.3.5 Calibration functions .....	17	<b>14.5</b>	<b>Software update .....</b>	<b>43</b>
8.3.6 Weighing mode .....	17	<b>15</b>	<b>Menu trees.....</b>	<b>44</b>
8.3.7 Interface functions .....	18	<b>15.1</b>	Configuration menu tree .....	44
8.3.8 Date and time .....	19	<b>15.2</b>	Application menu tree .....	46
8.3.9 Menu lock .....	19			
8.3.10 Anti-theft encoding.....	19			
8.3.11 Key tone .....	20			
8.3.12 Tone.....	20			
8.3.13 BUS.....	21			
<b>8.4 Special operating keys .....</b>	<b>21</b>			
8.4.1 The tare key .....	21			
8.4.2 The print key .....	21			
8.4.3 The change key .....	22			
<b>8.5 Application menu .....</b>	<b>22</b>			
8.5.1 Activating the application menu .....	22			

## 5 Introduction

These balances are simple and functional to operate.

The versatile weighing programs allow you to use these balances not only for simple weighing procedures but also in a simple manner for carrying out various weighing applications such as, for example, percentage- or component counting weighings and document the measurements obtained accurately and unequivocally. Virtually all models can be delivered in weights and measures approved.

The most important basic production features of the Precisa balances include:

- Simple-to-use 10-key multifunction control panel
- LCD- or fluorescent display with multi-line display
- Anti-theft encoding with four-figure numerical code
- 10 user profiles (MUM Multiuser Memory)
- ICM-Autocalibration (intelligent calibration mode)
- RS232/V24 serial interface for data transfer
- ISO- and GLP-compliant reporting of results of measurements
- Capacity and residual tare display
- Storable user-profiles
- Various application programs:  
Piece counting, Percentage weighing, Formulation, Animal weighing, Differential Weighing, Calculator, Check and reference weighing
- Statistics program
- Appliance for below-balance weighing

### 5.1 Useful tips on the Operating Instructions

You should read through these operating instructions in their entirety, so that you can make optimum use of the full potential and the diverse features of the balance in your daily work.

These operating instructions contain guidance in the form of pictograms and keyboard diagrams, which should help you find the required information:

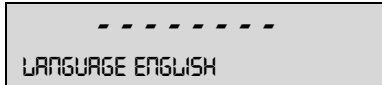

- Key names are presented in quotation marks and are highlighted in semi-bold script:  
«**ON/OFF**» or «**↻**».
- When explaining the operating steps, the appropriate display for the current operating step is shown for clarity at the left alongside the list of operating steps:

Display	Key	Step
		<i>Press repeatedly, until the language currently activated is displayed.</i>

## 6 Safety

### 6.1 Representations and symbols

Important safety instructions are highlighted with the appropriate symbol:

 <b>DANGER</b>
Warning of a possible danger which can lead to death or to serious injuries.
 <b>CAUTION</b>
Warning of a possibly dangerous situation which can lead to less severe injuries or damage.
 <b>NOTE</b>
Tips and important rules on the correct operation of the balance.

### 6.2 Safety recommendations

- When using the balance in surroundings with increased safety requirements the corresponding regulations must be observed.
- The balance may only be used with the power adaptor supplied exclusively for use with this balance.
- Before plugging in the power adaptor, make sure that the operating voltage stated on the power adaptor agrees with the mains voltage. If not, please refer to the Customer Service.
- If the power adaptor or its cable is damaged, the balance must immediately be disconnected from the electricity supply (pull out the power adaptor). The balance may only be operated with a power adaptor in perfect condition.
- If there is any reason to believe that it is no longer possible to operate the balance without danger, the balance must immediately be unplugged from the electricity supply (pull out power adaptor) and secured against inadvertent operation.
- In carrying out maintenance work, it is essential to heed the recommendations in chapter 14.1 "Maintenance and servicing".
- The balance must not be operated in an area subject to explosion risks.
- Take care when weighing liquids that no liquid is spilt into the inside of the balance or into connections on the rear of the equipment or the power adaptor.  
If liquid is spilt on the balance, the latter must immediately be unplugged from the mains electricity supply (pull out power adaptor).  
The balance may only be operated after it has first been re-checked by a Service technician.
- The operating instructions must be read by each operator of the balance and must be available at the workplace at all times. The balance may only be used for the weighing of solid-materials and of liquids filled into secure containers and for animal weighing and density determinations. The maximum allowable load of the balance must never be exceeded, otherwise the balance may be damaged.
- When using the balance in combination with other appliances, the current regulations for the safe use of the relevant attachments and their application in accordance with instructions must always be observed.

## 7 Set up

### 7.1 Unpacking the balance

The balances are delivered in an environmentally-friendly package, specifically developed for this precision instrument, which provides optimum protection for the balance during transportation.

#### NOTE

Retain the original packaging in order to avoid transportation damages when shipping or transporting the balance and to allow the balance to be stored in the best conditions if it is out of operation for an extended period.

In order to avoid damage, attention must be given to the following points when unpacking the balance:

- Unpack the balance carefully. It is a precision instrument.
- When outside temperatures are very low, the balance should first be stored for some hours in the unopened transport package in a dry room at normal temperature, so that no condensation settles on the balance when unpacking.
- Check the balance immediately after unpacking for externally visible damage. If you should find transport damage, please inform your Services representative immediately.
- If the balance is not to be used immediately after purchase but only at a later time, it should be stored in a dry place where fluctuations in temperature are as low as possible (see chapter 7.3 "Storage").
- Read through these operating instructions, even if you already have experience with balances, before you work with the balance and pay attention to the safety recommendations (see chapter 6 "Safety").

### 7.2 Transport and shipping

Your balance is a precision instrument. Treat it with care.

Avoid shaking, severe impacts and vibration during the transportation.

Take care that there are no significant temperature fluctuations during the transportation and that the balance does not become damp (condensation).

#### NOTE

The balance should preferably be dispatched and transported in the original packaging to avoid transportation damage.

### 7.3 Storage

If you would like to take the balance out of service for an extended period, disconnect it from the electricity supply, clean it thoroughly (see chapter 14.1 "Maintenance and servicing") and store it in a place which meets the following conditions:

- No violent shaking, no vibrations
- No significant temperature fluctuations
- No direct solar radiation
- No moisture

#### NOTE

The balance should preferably be stored in the original packaging, since this provides optimum protection for the balance.

## 7.4 Choosing a suitable location

The balance location must be chosen in such a way as to guarantee perfect operation of your balance, so that the allowable ambient conditions and prerequisites are met and maintained:

- Put the balance on a solid, firm and preferably vibration-proof, horizontal base
- Make sure that the balance cannot be shaken or knocked over
- Protect from direct solar radiation
- Avoid drafts and excessive temperature fluctuations

### ! NOTE

With difficult conditions (where the balance may be easily shaken or subject to vibration) the balance can nevertheless provide accurate results through suitable adjustment of the stability control (see chapter 8.3.6 "Weighing mode").

## 7.5 Connecting the balance to the mains

The following safety recommendations must be observed when connecting the balance to the mains:

### ! DANGER

**The balance may only be operated with the power adaptor supplied.**

**Check before connecting the power adaptor to the mains supply that the operating voltage stated on the balance or on the power adaptor agrees with the local mains voltage.**

**If the operating voltage is not the same as the mains voltage, the balance or the power adaptor must on no account be connected to the mains supply. Contact the Customer Service.**

## 7.6 Levelling

To function properly, the balance must be precisely horizontal.

The balance is fitted with one spirit level and two adjustable feet for level-control, with the aid of which it is possible to compensate for small height differences and/or unevennesses in the surface on which the balance is standing.

The two screw feet must be adjusted so that the air bubble is precisely in the centre of the sight glass of the bubble level.

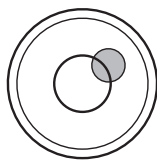

Incorrect

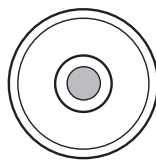

Correct

### ! NOTE

In order to get exact measurements, the balance must again be carefully levelled after each relocation.

## 7.7 Calibration of the balance

Since the Earth's gravity is not the same everywhere, each balance must – in accordance with the underlying physical weighing principle – be adjusted to compensate for the gravity at each location. This adjustment process, known as “calibration”, must be carried out on initial installation and after each subsequent relocation. In order to get exact measurements, it is recommended moreover, that the balance should also be calibrated periodically.

### ! NOTE

The balance must be calibrated on initial installation and after every relocation.

If you work in accordance with “Good Laboratory Practice GLP” observe the prescribed intervals between calibrations (adjustments).

Calibration is effected in the configuration menu. Depending on the balance model, this may be done externally, internally or automatically (see chapter 8.3.5 “Calibration functions” and see chapter 14.3 “Calibration”).

With the aid of the “Intelligent Calibration Mode” the balance can itself determine the size of the calibration weight, which enables an exact calibration with different size weights (in 10 g, 50 g, 100 g and 500 g steps, depending on implementation).

## 7.8 Dual Range and Floating Range balances

With the Dual Range balances, weighing is always first carried out in the fine range, which is 10 times more precise. When the fine range is exceeded the balance switches automatically into the coarse range.

The Floating Range balances have a fine range (10 times more precise), which moves over the entire weight range. By pressing the tare key «T» the fine range can be called up as often as required over the entire weight range.

## 7.9 Standardized balance

The standardized balances are provided with the EC/OIML certification or meet the local standardisation regulations.

The balance range and certain functions of the weighing output differ from the standard program in the case of the standardized balances – in accordance with the EC/OIML provisions.

### ! NOTE

If a circle appears in the main-display of a standardized balance, the indicated value is unstandardised.

In balances of class (1) the circle also stands for the warm-up phase.

Your Customer Service will be happy to assist you at any time if you have any questions on the standardization of the balance or on working with standardized balances.

## 7.10 Switching on the balance

- Press «ON/OFF» to switch on the balance.

The balance carries out a diagnostic test in order to check the most important functions. After completion of the start-up process (approximately ten seconds) “Zero” appears in the display.

The balance is ready for operation and is in the Weighing mode.

## 7.11 Auto-Standby Mode

The balance is equipped with an Auto-Standby mode, which can be activated or deactivated in the configuration menu.

If the Auto-Standby mode is activated, the balance automatically switches to Standby some time after the last weighing or key operation (current-saving function).

The delay before switching to Standby is defined in the configuration menu (see chapter 8.3.6 “Weighing mode”).

- Press any button or put on a weight in order to switch the balance from the Standby mode back to the Weighing mode again.

## 8 Operation

The balance has two main menus available: the configuration menu and the application menu.

The basic program of the balance is defined in the **configuration menu**. With this, you can either work with the basic configuration programmed ex-works, or define and store a user configuration adapted to your specific needs.

In the **application menu**, you may define an application program which is suited to the specific weighing problem.

In addition, you may also define the parameters for the statistics program, check-reference weighing and the user profile in the application menu.



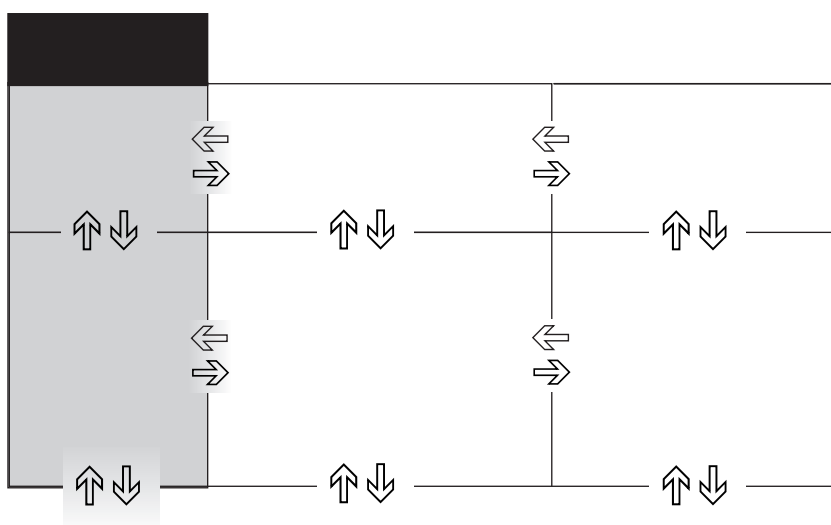

### 8.1 Menu control operation principle

The configuration menu and the application menu each have several menu levels in which the parameters for the different function programs of the balance are defined.

You can move within the menu with the cursor keys «←», «→», «↑» and «↓».

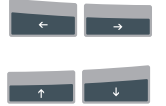

#### 8.1.1 Operating in the Weighing mode

Keys	Designation	Function in Weighing mode
	«ON/OFF»	• Switching the balance on and off
	«MENU»	• Calling up the Configuration Menu and the Application Menu
	«T»	• Initiate Tare Function and/or Calibration Function
	«↻»	• Switches between the Basic program and the chosen application
	«PRINT»	• Start print function
	«↑» «←» «→» «↓»	• Function keys. Start the functions in the Info display.









#### NOTE

For the operation of the «T», «↻» and «PRINT» see chapter 8.4 "Special operating keys".

## ■ 8 Operation

### 8.1.2 Operation in the programming mode

Keys	Designation	Function in programming mode
	«←», «→»	<ul style="list-style-type: none"> <li>Changes within the menu level</li> </ul>
	«↑», «↓»	<ul style="list-style-type: none"> <li>Up/Down movements within the menu</li> <li>Changes selected parameters</li> </ul>
	«←↓»	<ul style="list-style-type: none"> <li>Selects parameters</li> <li>Stores the changed parameters</li> </ul>
	«esc»	<ul style="list-style-type: none"> <li>Interrupts an input</li> <li>Leaves the menu</li> </ul>
	«ins»	<ul style="list-style-type: none"> <li>Places insert marker (on keyboard entry)</li> </ul>
	«clr»	<ul style="list-style-type: none"> <li>Deletes input (on keyboard entry)</li> </ul>
	«PRINT»	<ul style="list-style-type: none"> <li>Inputs a point (on keyboard entry)</li> </ul>

The balance can also be operated by remote control. For the corresponding remote control-commands see chapter 13.2 "Remote control-commands".

## 8.2 Setting the factory configuration

- Press «ON/OFF» to switch the balance on.
- During the start-up process, hold down the «T» and «MENU» keys until „FACTORY CONFIG.“ appears in the display, then release the keys. The balance loads the factory configuration.

## 8.3 Device configuration

This section explains the structure of the configuration menu and its functions.

The basic adjustment of the balance is defined in the configuration:

Menu	Definable functions
<b>UNIT-1</b>	Unit in which the weighing results are displayed
<b>SET DATA PRINT</b>	Print formats; Type of values to be printed (individual values, continuous printout, time or load change dependent values, date, time, user, etc.)
<b>SET CALIBRATION</b>	Calibration method
<b>SET WEIGHING MODE</b>	Stability mode (Quality of the balance location), Auto-Standby mode, zero correction, tare method (rapid or standard tare)
<b>SET INTERFACE</b>	Baud rate, parity, handshake functions of the peripheral interface
<b>SET DATE AND TIME</b>	Date and time (standard format or American format p.m. and a.m.)
<b>MENU LOCK</b>	Activating/deactivating and changing the menu protection.
<b>THEFTCODE</b>	Activating/deactivating and changing the anti-theft code.
<b>KEY TONE</b>	Activation of the keypad sound
<b>STONE</b>	Select the sound of the keytone, if activated
<b>BUS</b>	Activating/deactivating the Precisa BUS system for accessories
<b>LANGUAGE</b>	Display language (E, G, F)

- The settings in the sub-paths pre-programmed at the factory are printed here in **bold**.
- For greater clarity, only that part of the menu tree which corresponds to the function is shown with each description of the function.
- You will find the entire menu tree for the configuration menu in see chapter 15.1 "Configuration menu tree".
- Explanations of the menu functions are printed in *italics*.



### 8.3.1 Activating the configuration menu

- Press «ON/OFF» to switch the balance on.
- Hold down the «MENU» key continuously during the start-up process (which takes about ten seconds) until „UNIT-1“ appears in the display.
- You can now change the configuration menu.

### 8.3.2 Language function

• LANGUAGE	
SPRACHE	DEUTSCH
LANGUAGE	ENGLISH
LANGUE	FRANCAISE

*Selecting a language*

Procedure for changing the language:

Display	Key	Step
<div style="border: 1px solid black; padding: 5px; text-align: center;">           -----            SPRACHE DEUTSCH         </div>	«↓»	<i>Press repeatedly, until the language currently activated is displayed.</i>
<div style="border: 1px solid black; padding: 5px; text-align: center;">           -----            SPRACHE DEUTSCH         </div>	«↵»	<i>The language now flashes.</i>
<div style="border: 1px solid black; padding: 5px; text-align: center;">           -----            LANGUAGE ENGLISH         </div>	«↑»	<i>Press repeatedly until the language you require appears.</i>
<div style="border: 1px solid black; padding: 5px; text-align: center;">           -----            LANGUAGE ENGLISH         </div>	«↵»	<i>To confirm the choice of language.</i>

Press «esc» to exit the menu.

### 8.3.3 Selecting the weight unit

• UNIT-1	
UNIT-1	g
	kg
	----
	Bht

*Gram*  
*Kilogram*  
*Baht*

The balance can show results in different units, although with some balances display is not possible in milligram or kilogram because of the corresponding weight range.

Display	Weight unit	Conversion to gram
g	Gram	
(mg)	Milligram	0,001 g
(kg)	Kilogram	1000 g
GN	Grain	0,06479891 g
dwt	Pennyweight	1,555174 g
ozt	Troy ounce	31,10347 g
oz	Ounce	28,34952 g
Lb	Pound	453,59237 g
ct	Carat	0,2 g
C.M.	Carat Metric	0,2 g
tLH	Tael Hong Kong	37,4290 g
tLM	Tael Malaysia	37,799366256 g
tLT	Tael Taiwan	37,5 g
mo	Momme	3,75 g
t	Tola	11.6638038 g
Bht	Baht	15.2 g

## ■ 8 Operation

Procedure for changing the weight unit:

Display	Key	Step
UNIT-1 9	«↓»	Press repeatedly, until „UNIT-1“ is displayed.
UNIT-1 9	«↵»	The unit now flashes
UNIT-1 LB	«↓»	Press repeatedly, until the unit you require appears.
UNIT-1 LB	«↵»	To confirm the choice of unit.

Press «esc» to exit the menu.

### 8.3.4 Print functions

• SET DATA PRINT			
AUTOSTART	ON/OFF	Start print automatically on switching on/off	
MODE	UNSTABLE	Individual print, each value	
	<b>STABLE</b>	Individual print, stable value	
	LOADCHANGE	Print after load changes	
	CONTINUOUS	Continuous print after every integration time	
	TIMEBASE	Continous print with time basis	
TIMEBASE	2.0	Time basis (in seconds) freely selectable	
SET PRINTFORMAT	DATE AND TIME	ON/OFF	
	BALANCE-ID	ON/OFF	
	PRODUCT-ID	ON/OFF	
	GROSS AND TARE	ON/OFF	
	UNITS	ON/OFF	
	USER	ON/OFF	
	LINEFEED	OFF/1/2/..9/FROMFEED	
	PRODUCT	ttt...	
	PRODUCTMODE	<b>HOLD</b>	
		DELETE	
	COUNT		
PRODUCT INFO	ON/OFF		

#### „SET PRINTFORMAT“

Elements which are switched on are printed in each case.

#### „UNITS“

All currently active units are printed out.

#### „PRODUCT ttt...“ (only available when „PRODCUT-ID“ ON)

The product name can be entered alpha-numerically. This can also be done in normal weighing mode by input via a barcode scanner, the RS232 interface or the ITK decimal keypad with <SHIFT>: e.g. <SHIFT>, <ENTER>, „SCREWS“, <SHIFT>, „123“, <ENTER>, <ESC>.

#### „PRODUCTMODE“ (only available when „PRODCUT-ID“ ON)

- „HOLD“: The product name is stored.
- „DELETE“: The product name is deleted after each printout.
- „COUNT“: After the product name, a counter is printed, which is always increased by 1.

#### „PRODUCT INFO“ (only available when „PRODCUT-ID“ ON)

- „ON“: The product name is displayed in the Info display.
- „OFF“: The product name is not displayed.

When a peripheral device (for example a printer) is connected, the balance interface must be configured in

the sub-menu „SET INTERFACE“ (see chapter 8.3.7 "Interface functions").

### 8.3.5 Calibration functions

• SET CALIBRATION		
MODE	OFF EXTERNAL EXT.-DEF. <b>INTERNAL</b> AUTO	<i>Closed</i> <i>External</i> <i>External with user-defined weight („DEF. n.nnn g“)</i> <i>with internal weight</i> <i>Automatic (AUTOCAL)</i>
DEF.	<b>0.000 g</b>	<i>Calibration weight for EXT.-DEF. mode</i>
AUTOCAL.	<b>TIME/TEMP.</b> TEMPERATURE TIME	<i>Auto-calibration on time and temperature</i> <i>Auto-calibration on temperature</i> <i>Auto-calibration on time</i>
AUTOCAL.-TIME	<b>6 h</b>	<i>Time for auto-calibration</i>

For calibration of the balance see chapter 7.7 "Calibration of the balance" and see chapter 14.3 "Calibration". The setting depends on the balance model.

### 8.3.6 Weighing mode

• SET WEIGHING MODE		
FLOATINGDISPLAY	0.04 0.08 <b>0.16</b> 0.32	<i>Input integration time (in seconds)</i>
STABILITY	LOW <b>MEDIUM</b> HIGH	<i>Setting the stability control (instability of the balance location)</i>
AUTO-STANDBY	<b>OFF</b> 0.5 MIN. 1 MIN. 5 MIN. 10 MIN.	<i>Auto-Standby not active or active after nn minutes</i>
AUTO-ZERO	<b>ON/OFF</b>	<i>Automatic zero correction on/off</i>
QUICK-TARE	<b>ON/OFF</b>	<i>Quick-Tare on/off</i>
ZERO-RANGE	<b>0.0 g</b>	<i>Maximum weight where a zero function is performed instead of a tare function</i>

With the aid of the Weighing mode functions, you may define the quality of the balance location (see chapter 7.4 "Choosing a suitable location").

With the aid of the „AUTO-STANDBY“ function, you can define the period of non-use before the balance automatically switches into the energy-saving mode.

#### ! NOTE

The Auto-Standby function only works with the automatic zero-correction activated („AUTO-ZERO“).

#### „FLOATINGDISPLAY“

The value set for „FLOATINGDISPLAY“ defines the period after which each new measurement is displayed. For the definition of this period, the quality of the balance location is crucial. The stability control must also set appropriately.

Recommended values:

- Optimum balance location: „FLOATINGDISPLAY 0.04 or 0.08“
- Good balance location: „FLOATINGDISPLAY 0.16“
- Critical balance location: „FLOATINGDISPLAY 0.32“

**! NOTE**

The value of the Floating Display is a function of the stability control and the balance location. For balance location, see chapter 7.4 "Choosing a suitable location" and see chapter 8.3.6 "Weighing mode".

**„STABILITY“**

The value set for the stability control depends on the quality of the balance location and must be correctly chosen in order to obtain optimum, reproducible results. Choose:

- Optimum balance location: „STABILITY LOW“
- Good balance location: „STABILITY MEDIUM“
- Critical balance location: „STABILITY HIGH“

**„AUTO-STANDBY“**

The Auto-Standby mode turns off the balance automatically, if:

- the balance is tared and has shown "Zero" for at least 5 minutes
- the balance has received no remote control command via the interface for at least 5 minutes,
- the automatic zero correction „AUTO-ZERO“ is activated.

It is possible to re-start the balance after it has been switched off by an automatic Auto-Standby:

- Briefly press any key
- Put a weight on the balance
- Make a remote control command via the interface

**„AUTO-ZERO“**

If the automatic zero correction „AUTO-ZERO“ is activated, the balance always gives a stable zero (e.g. even with fluctuations in room temperature).

**„QUICK-TARE“**

Tares the balance immediately when «0/T» is pressed or when the remote control command for taring is received, regardless of whether a stable weight value is reached or present.

**„ZERO-RANGE“**

Defines the maximum weight value at which the balance performs a zero function instead of normal taring when the «0/T» key is pressed or the remote control command for taring is received. This value can be adjusted to ensure that a small load is stored as tare and appears accordingly on a printout.

**8.3.7 Interface functions**

• SET INTERFACE		
MODE	<b>STANDARD</b> PC DIRECT HID	Select STANDARD(-RS232), PC DIRECT or HID mode of interface
CHARACTER SET	<b>ENG</b> GER FRA	In PC DIRECT or HID mode: keyboard emulation in English, German or French
FORMAT	<b>LINES</b> TABLE	In PC DIRECT or HID mode: Data output as normal lines or as table
BAUDRATE	300 600 1200 2400 4800 <b>9600</b> 19200	In mode STANARD or PC DIRECT: Select baud rate
PARITY	<b>7-EVEN-1STOP</b> 7-ODD-1STOP 7-NO-2STOP 8-NO-1STOP	In mode STANDARD: Select parity

	HANDSHAKE	<b>NO</b> XON-XOFF HARDWARE	<i>In mode STANDARD: Select handshake function</i>
--	-----------	-----------------------------------	--

The RS232/V24 interface on the device is matched to the interface of a peripheral device with the aid of the interface functions (see chapter 13 "Data transfer").

#### „MODE“

- „STANDARD“: Standard RS232 Interface
- „PC DIRECT“: Direct connection to a PC running Windows Vista and older versions.
- „HID“: Connection with the as accessories available as HID cable to a PC as a Human Interface Device, see chapter 4 "Accessories".

### 8.3.8 Date and time

<b>• SET DATE AND TIME</b>			
	DATE	[DD.MM.YY]	<i>Set date and time</i>
	TIME	[HH.MM.SS]	
	FORMAT	<b>STANDARD/US</b>	

#### ! NOTE

If a power failure occurs, the timer continues running. If this does not happen, this indicates that the instrument's backup battery has expired and has to be replaced by the Customer Service.

### 8.3.9 Menu lock

<b>• MENU LOCK</b>			
MENU LOCK - - - -	SET MENU	<b>OFF</b> CONF. CONF. + APP.	<i>No protection</i> <i>The configuration menu is protected</i> <i>The configuration menu and the application menu are protected</i>
	NEW PASSWORD	----	<i>Enter new password</i>

The password protection permits you to protect the application menu and/or the configuration menu against unintentional changes.

#### ! NOTE

**The password protection is deactivated in the factory settings.**  
The **factory programmed password** can be found on our website at your dealer login. It is always valid, at the same time with your new selected password.  
Keep a record of your **own password**.

### 8.3.10 Anti-theft encoding

<b>• THEFTCODE</b>			
THEFTCODE - - - -	THEFT-PROTECTION	<b>ON/OFF</b>	<i>Switch encoding on/off</i>
	NEW CODE	----	<i>Enter a new code</i>

The balance can be protected against theft by using a freely selectable, four-digit numerical code:

- If the anti-theft code is deactivated, the instrument can be re-started and operated after a power outage without having to enter a code.
- If the anti-theft code is activated, the instrument requires the code to be input after each power outage.
- If the code is entered incorrectly, the instrument is locked.
- If the instrument is locked, it must first be disconnected from the power supply, then reconnected and unlocked by entering the correct code.
- After seven consecutive incorrect entries, the display reads „NO ACCESS, CALL SERVICE“. In this case only a service engineer can unlock the instrument again.

## 8 Operation

### NOTE

The anti-theft encoding is deactivated in the factory settings.

The preprogrammed code set at the factory is: **8 9 3 7**

This code is the same in all balances. Therefore, for security reasons, enter your own code.

Keep your **own code** in a safe place.

Procedure to activate the anti-theft encoding:

Display	Key	Step
THEFTCODE - - - -	«↓»	Press repeatedly, until the „THEFTCODE“ is displayed.
THEFTCODE 0 0 0 0	«↵»	The first digit in the code flashes and can be changed.
THEFTCODE 8 0 0 0	«↓»	Press repeatedly, until the first digit in the code is set.
THEFTCODE 8 0 0 0	«⇒»	The second digit flashes. The code can now be entered fully.
THEFTCODE 8000	«↵»	Confirm the theft code.
THEFT-PROTECTION OFF	«⇒»	The theft-protection can now be set.
THEFT-PROTECTION OFF	«↵»	The display flashes, and the theft-protection can be activated.
THEFT-PROTECTION ON	«↓»	Activate the theft-protection.
THEFT-PROTECTION ON	«↵»	Confirm the theft-protection.

The procedure for changing the code is as follows:

Display	Key	Step
NEW CODE 8 9 3 7	«↓»	Press repeatedly, until „NEW CODE“ appears. Set the new code as described above.

### 8.3.11 Key tone

#### • KEY TONE

KEY TONE	ON/OFF	Switch key tone on and off
----------	--------	----------------------------

If the key tone is switched on, a short audio signal sounds each time a key is pressed.

### 8.3.12 Tone

#### • TONE

TONE	SOUND 1	Choose the sound of the key tone
	SOUND 2	
	<b>SOUND 3</b>	
	SOUND 4	
	SOUND 5	

### 8.3.13 BUS

• BUS	
BUS	OFF/ON <i>Set the Precisa BUS system on and off</i>

The Precisa BUS system must be enabled when Precisa BUS accessories are connected, see chapter 4 "Accessories".

## 8.4 Special operating keys

### 8.4.1 The tare key

- **Activating taring**
  - Ensure that the balance is in the Weighing mode
  - Briefly press «T»
  - The balance performs a tare operation.
- **Range selection**

(This option is only available on dual range or floating range balances)

  - Ensure that the balance is in the Weighing mode
  - Hold down «T» until „RANGE FINE ON“ or „RANGE FINE OFF“ is displayed
  - Release «T»
  - If „RANGE FINE OFF“ is selected the balance is working only in the 10 times less accurate coarse range.
- **Activating calibration**
  - Ensure that the balance is in the Weighing mode
  - Hold down «T» until „CALIBRATION“ is displayed
  - Release «T»
  - The balance carries out a calibration sequence in accordance with the settings in the configuration menu (see chapter 8.3.5 "Calibration functions") and reports these by means of a print-out.
- **Activating an automatic repeatability test (ART)**
  - Ensure that the balance is in the Weighing mode
  - Hold down «T» until „REPEATABILITY TEST“ is displayed
  - Release «T»
  - The balance carries out an automatic repeatability test and the results are printed out (see chapter 14.4 "Automatic Repeatability Test (ART)").



#### NOTE

The calibration can be interrupted with the «ON/OFF» key.

### 8.4.2 The print key

- **Print out an individual value or a report**
  - Ensure that the balance is in the Weighing mode
  - Briefly press «PRINT»
  - The individual value or report will be printed out.
- **Reset product counter to 1**
  - Ensure that the balance is in the Weighing mode
  - Hold down «PRINT» until „RESET PROD.-COUNTER“ is displayed
  - Release «PRINT»
  - The product counter will be reset to 1.
- **Print out a balance status**
  - Ensure that the balance is in the Weighing mode
  - Hold down «PRINT» until „PRINT STATUS“ is displayed
  - Release «PRINT»
  - The balance status will be printed out.
- **Print out the application-setup**
  - Ensure that the balance is in the Weighing mode
  - Hold down «PRINT» until „PRINT APPLICATIONS“ is displayed
  - Release «PRINT»
  - The application-setup will be printed out.

## ■ 8 Operation

### • Print out the calibration information

- Ensure that the balance is in the Weighing mode
- Hold down «**PRINT**» until „PRINT CALIBRATIONS“ is displayed
- Release «**PRINT**»
- Information on the last 50 calibrations is printed. The time and date, as well as the temperature in the balance at the time of calibration in degrees Celsius. If more than 50 calibrations have been performed, the oldest are deleted.

### 8.4.3 The change key

#### • Switch to other applications

- As long as you hold «**↻**», all active applications are shown one after the other: if, for example, the statistics program, the check program and the count application are activated, „WEIGHING“, „STATISTIC“, „CHECK“ and „COUNT“ appear in the Info display one after the other:
- Release «**↻**» when the application to which the balance should be switched, appears in the display.

## 8.5 Application menu

The balance application programs are called up using the application menu and adapted to the user's needs:

Menu	Definable functions
<b>SET APP.</b>	Select application program
<b>SETUP APPLICATION</b>	Specify parameters for the application program selected
<b>SET STATISTIC</b>	Statistics and storage functions
<b>SET CHECK +/-</b>	Define nominal weight and limits for comparison weighing
<b>etc.</b>	Other functions available. Refer to the Application Operating Instructions for the description.
<b>AUTO-START ON/OFF</b>	The selected application program can, if required, be loaded automatically every time the balance is switched on
<b>SET USER</b>	Define user profile

- The settings for the sub-menus programmed in works are printed here in **bold**
- For greater clarity, only that part of the menu tree which corresponds to this application is shown with each application description.
- You will find the complete menu tree for the application menu in see chapter 15.2 "Application menu tree".
- Explanations of the menu functions are printed in *italics*.

### 8.5.1 Activating the application menu

- Press «**MENU**» after the start-up procedure has ended in order to access the application menu.

### 8.5.2 Selecting an application program

• SELECT APPLICATION		
<b>SET APP.</b>	<b>OFF</b>	<i>normal weighing</i>
	UNITS	<i>different weight units</i>
	COUNT	<i>Piece counting</i>
	PERCENT	<i>Percent weighing</i>
	CALCULATOR	<i>Conversions</i>
	PAPER	<i>Determine paper weight (in g/cm<sup>2</sup>)</i>
	NET-TOTAL	<i>Add weighing results with intermediate tare</i>
	SUM	<i>Add weighing results without intermediate tare</i>
	ANIMAL	<i>Animal weighing</i>
	...	...
	etc.	<i>Other functions available.</i>
		<i>Refer to the Application Operating Instructions for the description</i>

In this function-field, select the desired application program.

If an application program is selected in the „SET APP.“ menu, then only those sub-menus, which contain



functions and parameters necessary to define the chosen application program are shown in the „SETUP APPLICATION“ menu.

**NOTE**

Refer to the Application Operating Instructions for a description of applications which are not described in these Operating Instructions.

## 9 Application

### 9.1 Units

• SETUP APPLICATION			
UNITS	UNIT-2	mg	Milligram
		----	----
		OFF	not active
	UNIT-3	GN	Grain
		----	----
		OFF	not active
	UNIT-4	ct	Carat
		----	----
		OFF	not active

Assigning the function keys:

Key	Function
«g»	Show measurement in unit 1, e.g. Gram
«mg»	Show measurement in unit 2, e.g. Milligramm
«GN»	Show measurement in unit 3, e.g. Grain
«ct» or «STO»	Show measurement in unit 4, e.g. Carat or Statistics functions if the statistics-program is activ



#### NOTE

For basic operation, Unit 1 is defined in the Configuration menu. This is the standard unit for all weighing operations unless the application „UNIT“ is not running, see chapter 8.3.3 "Selecting the weight unit".

Display	Key	Step
	«↺»	Press until „UNITS“ appears.
	«⇒»	The weight is displayed as milligrams,

By pressing the relevant function key the weight display is switched to the corresponding unit.

The weight is printed in the unit of measurement shown by pressing the «PRINT» key.

### 9.2 Count

• SETUP APPLICATION			
COUNT	KEY-1	5	Reference-number of pieces = 5
	KEY-2	10	Reference-number of pieces = 10
	KEY-3	25	Reference-number of pieces = 25
	KEY-4	50	Reference-number of pieces = 50
	REF. OPTIMIZATION	MODE	PARTS-TOL. < 5% PARTS-TOL. > 5% OFF
		INFO	ON/OFF
	REF.ACCURACY	0.01d 0.1d 1d	Round the value of the reference piece weight according the readability of the balance (1d = digit displayed at place most right)

With the aid of the „COUNT“ program you can count items of uniform weight (screws, bearings, coins, etc.). For this, you must place a defined number of items (for example, 5) on the balance and determine the ref-

reference piece weight by pressing the corresponding function key. If a tare value was entered manually or via the interface (PC), the reference point must first be measured..

### ! NOTE

Depending on the weight and tolerances of the objects to be counted, you should count a representative number of items for the regulation of the reference-weight.

#### Assigning the function keys:

Key	Function
«5»	Set reference-number of pieces to 5
«10»	Set reference-number of pieces to 10
«25»	Set reference-number of pieces to 25
«50» oder «STO»	Set reference-number of pieces to 50 or Save in statistics or recorder if the statistics-program is activ

#### Working without Tare value entry)

Display	Key	Step
<div style="border: 1px solid black; padding: 2px;">           + 0,0000 9 COUNT         </div>	«C»	Press until „COUNT“ appears.
<div style="border: 1px solid black; padding: 2px;">           + 12,1596 9 5 10 25 50         </div>		apply (or remove) e.g 25 pieces
<div style="border: 1px solid black; padding: 2px;">           + 25 PCS 5 10 25 50         </div>	«↑»	The reference piece weight is calculated and the weight displayed in pieces (PCS).

The quantity shown is printed by pressing the «PRINT» key.

#### Working with Tare value entry on keypad or via PC (interface), as in this example e.g. 20.0000g:

Display	Key	Step
<div style="border: 1px solid black; padding: 2px;">           + 10.0000 9 PT COUNT NET         </div>	«C»	Press until „COUNT“ appears.
<div style="border: 1px solid black; padding: 2px;">           + 10.0000 9 PT NET 5 10 25 50         </div>	«↑»	25 is flashing, the reference point is measured
<div style="border: 1px solid black; padding: 2px;">           + 35.0000 9 PT NET 5 10 25 50         </div>	«↑»	apply (or remove) e.g 25 pieces
<div style="border: 1px solid black; padding: 2px;">           + 35 PCS PT NET 5 10 25 50         </div>	«↑»	The reference piece weight is calculated and the weight displayed in pieces (PCS).

The quantity shown is printed by pressing the «PRINT» key.

#### Working with reference piece weight value entry on the keypad with the <Star> key or via PC (interface)

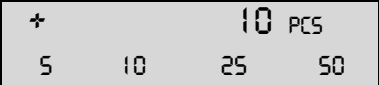

Display	Key	Step
<div style="border: 1px solid black; padding: 2px;">           + 0.0000 9 ZAEHLER         </div>	«C»	Press until „COUNT“ appears.
<div style="border: 1px solid black; padding: 2px;">           + 12.1596 9 5 10 25 50         </div>		Enter the reference piece weight 1,21596 g on the numeric keypad with „*1.21596“<ENTER> (i.e. <Star> „1.21596“<ENTER>)

## ■ 9 Application

Display	Key	Step
	«↑»	The reference piece weight is set and the weight displayed in pieces (PCS).

The quantity shown is printed by pressing the «PRINT» key.

### Working with reference-number value entry on the keypad with the <Point> key or via PC (interface)

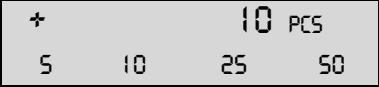
Display	Key	Step
	«C»	Drücken bis „ZAEHLEN“ angezeigt wird.
		Enter the reference-number 10 on the keypad with „.10“<ENTER>.) (i.e. <Punkt> „10“<ENTER>.)
	«↑»	Das Referenzstückgewicht wird berechnet und der Gewichtswert wird in Stücke(PCS) angezeigt.

The quantity shown is printed by pressing the «PRINT» key.

### „REF. OTIMIZATION“

The reference optimization gradually improves the average value of the reference-piece weight and thus the counting. If an optimization is performed, briefly a little circle appears to the left in the weighing indicator. When optimizing the overlying number is taken as the new reference piece number and with this new basis, the reference piece weight is recalculated.

While recording a piece counting measurement series (statistic) no optimization is performed.

Basically no optimized will performed when the fix value of the reference piece weight was entered via the keyboard or a remote control command or received from a reference scale.

### „REF. OTIMIZATION - MODE OFF“

No optimized is performed

### „REF. OTIMIZATION - MODE PARTS-TOL. < 5%“

The individual parts weights should vary less than 5% of each other.

Condition for carrying out the reference optimization:

- The balance is stable
- The current number of pieces is min. 3 PCS larger than the last reference sample quantity.
- The current quantity is a maximum 10x as big as the last reference sample quantity.
- The current internally calculated piece count (e.g. 23:27 PCS) does not deviate more than +/-0.3 PCS from the nearest whole number (here 23 PCS).

Advantage: Because for every optimization level up to 10 times the amount of the previous piece may be placed, a few intermediate stages (e.g.: 5 PCS, PCS 50, 500 PCS) to reach up the total amount required piece. This enables a fast and yet accurate counting.

### „REF. OTIMIZATION - MODE PARTS-TOL. > 5%“

The individual parts Weights vary widely.

Condition for carrying out the reference optimization:

- The balance is at a standstill.
- The current number of pieces is min. 1 PCS (PCS to 20), respectively. 3 PCS (from 21 PCS) larger than the last reference sample quantity.
- The current quantity is a maximum 2x as big as of the last reference sample quantity.
- The current internally calculated piece count (eg 23:27 PCS) does not differ by more than +/- 0.3 PCS from the nearest whole number (here 23 PCS).

### „REF. OPTIMIZATION - INFO ON/OFF“

This menu does not appear when the reference optimization is off. Otherwise additional info are displayed on the display

### „REF. ACCURACY“

The "Ref. Accuracy "defines the accuracy with which the weight is taken on the scale. Since the scale can measure internally more accurate than it indicates, it makes sense to take the weight with a higher resolution

than that of the scales display. Choose:

#### „REF. ACCURACY - 0.01“

Recommended for very small parts weights.

The weight is taken with 100 times the resolution of the weighing indicator (= 0.01Digit).

E.g.: 5 PCS on the scale, the display value 15:12 g, internally measured value 15.1234 g

Weight for calculating is 15.1234 g, this gives a reference piece weight of 3.02468 g / PCS

#### „REF. ACCURACY - 0.1“

Recommended for small parts weights.

The weight is taken with 10 times the resolution of the weighing indicator (= 0.1Digit).

E.g.: 5 PCS on the scale, the display value 15:12 g, internally measured value 15.1234 g

Weight for calculating is 15.123 g, this gives a reference piece weight of 3.02460 g / PCS

#### „REF. ACCURACY - 1“

The weight is taken with the resolution of the weighing indicator (= 1Digit).

E.g.: 5 PCS on the scale, the display value 15:12 g, internally measured value 15.1234 g

Weight for calculating is 15.12 g, this gives a reference piece weight of 3.02400 g / PCS

## 9.3 Percent

• SETUP APPLICATION											
PERCENT	<table border="1"> <thead> <tr> <th>DECIMALS</th> <th>AUTO</th> </tr> </thead> <tbody> <tr> <td></td> <td>0</td> </tr> <tr> <td></td> <td>1</td> </tr> <tr> <td></td> <td>2</td> </tr> <tr> <td></td> <td>etc.</td> </tr> </tbody> </table>	DECIMALS	AUTO		0		1		2		etc.
DECIMALS	AUTO										
	0										
	1										
	2										
	etc.										

*Enter number of decimal places.  
The number of places that can be selected after the decimal point depends on the balance model.*

With the aid of the „PERCENT“ program you can display and print out the weight of different measurements as a percentage of a previously defined reference weight.

Assigning the function keys:

Key	Function
«SET»	The current weight is taken as reference for 100% and displayed
«STO»	Save in statistics or recorder if the statistics-program is activ

Working without Tare value entry:



Display	Key	Step						
<table border="1"> <tr> <td>+</td> <td>0.0000</td> <td>g</td> </tr> <tr> <td>PERCENT</td> <td></td> <td></td> </tr> </table>	+	0.0000	g	PERCENT			«C»	Press until „PERCENT“ appears.
+	0.0000	g						
PERCENT								
<table border="1"> <tr> <td>+</td> <td>13,4560</td> <td>g</td> </tr> <tr> <td>PERCENT</td> <td></td> <td></td> </tr> </table>	+	13,4560	g	PERCENT				apply (or remove) a weight
+	13,4560	g						
PERCENT								
<table border="1"> <tr> <td>+</td> <td>100,000</td> <td>%</td> </tr> <tr> <td>SET</td> <td></td> <td></td> </tr> </table>	+	100,000	%	SET			«⇐»	The reference percent weight is calculated and the weight displayed as 100%
+	100,000	%						
SET								

The percentage shown is printed by pressing the «PRINT» key.

Working with reference piece weight value entry on the keypad with the <Star> key or via PC (interface)

Display	Key	Step						
<table border="1"> <tr> <td>+</td> <td>0.0000</td> <td>g</td> </tr> <tr> <td>PERCENT</td> <td></td> <td></td> </tr> </table>	+	0.0000	g	PERCENT			«C»	Press until „PERCENT“ appears.
+	0.0000	g						
PERCENT								
<table border="1"> <tr> <td>+</td> <td>12.1596</td> <td>g</td> </tr> <tr> <td>SET</td> <td></td> <td></td> </tr> </table>	+	12.1596	g	SET				Enter the 100% reference weight 12,1596 g on the numeric keypad with „*12.1596“<ENTER> (i.e. <Star> „12.1596“<ENTER>)
+	12.1596	g						
SET								

## ■ 9 Application

Display	Key	Step
		<i>The reference percent weight is calculated and the weight displayed in %</i>

The percentage shown is printed by pressing the «**PRINT**» key.

### 9.4 Calculator

• SETUP APPLICATION		
CALCULATOR	SET KEY-1	NAME nnnnn
		FACTOR n.nnn e + n
		MODE <b>F * WEIGHT</b> F / WEIGHT
		DECIMALS n
	SET KEY-2	as for key 1
	SET KEY-3	as for key 1
	SET KEY-4	as for key 1
		DISPLAY-TEXT nnn
		PRINTER-TEXT nnnnnnnn

When the „CALCULATOR“ application is activated, each of the four function keys is assigned a calculation method with the following settings.

#### „NAME“

Function key name, max. 5 characters.

#### „FACTOR“

Factor by which the weight is to be offset.

#### „MODE“

Multiplication of the factor by the weight or division of the factor by the weight.

#### „DECIMALS“

Definition of number of decimal places are to be shown in the result.

#### „DISPLAY TEXT“

Unit shown in the display, max. 3 characters.





#### „PRINTER TEXT“

Unit being printed, max. 8 characters.

In the program operation, the previously defined names of the keys appear over the function keys.

After pressing a function key, the current measurement is converted in accordance with the factor assigned and the result shown or printed out after pressing the Print key.

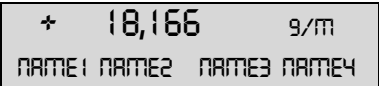
Thus, for example, you can convert and display the weights of sample materials of known size directly into “gram per cubic metre”.

Display	Key	Step
		<i>Press until „CALCULATOR“ appears.</i>
		<i>The measurement is recalculated accordingly.</i>

The calculated measurement is printed with the set printer text by pressing the «**PRINT**» key.





### 9.5 Paper

The setting up of the „PAPER“ program is similar to that for the calculator (see chapter 9.4 "Calculator").

With the aid of this program you can convert and display the weights of paper samples of standard sizes directly in “gram per square metre”.

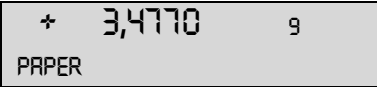
The standard variables 100 cm<sup>2</sup>, 20x25 cm, A4 and 40x25 cm are set as defaults and are assigned to the

function keys.

Display	Key	Step
		Hold down until „PAPER“ appears.
		The measurement is recalculated accordingly.

The calculated measurement is printed with the set printer text by pressing the «PRINT» key.











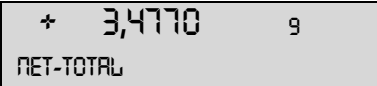

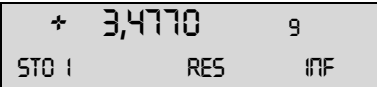

## 9.6 Net-Total

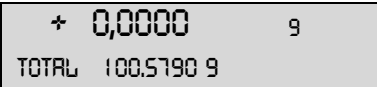
- **SETUP APPLICATION** *There is no Setup menu for this application!*

With the aid of the „NET TOTAL“ program you can add individual weighing results, where the balance is tared to zero again before each individual weighing procedure.

Assignment of the function keys:

Key	Function
«STO i»	Take stable value and add to the sum of the components
«WAIT i»	Value not stabilized yet
«RES»	Reset
«INF»	Change to display the total weight („TOTAL“), residual capacity („RES. CAP.“), individual values and again back to the normal display. Press «esc» to exit the INF display.

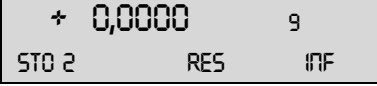
Display	Key	Step
		Press until „NET-TOTAL“ appears.
		Store the stable weight applied and add it to the sum of the components; the balance is tared.
		Add further weights
Retrieve the parameters:		
		Show the Info display. Display the total of the added components.
		Display the remaining capacity.
		Display the individual components.
	«esc»	Exit the Info display.
Clear the measurements:		
		Hold down the key until the acoustic signal sounds and the component counter is reset.

## ■ 9 Application

Display	Key	Step
<div style="border: 1px solid black; padding: 5px;">           + 0,0000 9            STO 0 RES INF         </div>		Measurements cleared, balance is ready for a new measurement.

A measurement log is printed by pressing the «PRINT» key.

### 9.7 Sum

• SETUP APPLICATION	There is no Setup menu for this application!
SUM	

With the aid of the „SUM“ program, you can add individual weighings, without the balance being tared to zero before each individual weighing.

Assignment of the function keys:

Key	Function
«STO i»	Take stable value and add to the sum of the components
«WAIT i»	Value not stabilized
«RES»	Reset
«INF»	Change to display the total weight („TOTAL“), residual capacity („RES. CAP.“), individual values and again back to the normal display. Press «esc» to exit the INF display.

Display	Key	Step
<div style="border: 1px solid black; padding: 5px;">           + 3,4770 9            SUM         </div>	«C»	Press until „SUM“ appears.
<div style="border: 1px solid black; padding: 5px;">           + 3,4770 9            STO 1 RES INF         </div>	«←»	Store the stable value and add it to the sum of the components.
<div style="border: 1px solid black; padding: 5px;">           + 8,58962 9            STO 2 RES INF         </div>	«←»	Add further weights.

Retrieve the parameters:

<div style="border: 1px solid black; padding: 5px;">           + 8,58962 9            TOTAL 8,58962 9         </div>	«↓»	Show the Info display. Display the total of the added component.
<div style="border: 1px solid black; padding: 5px;">           + 8,58962 9            RES. CAP. 396,41038 9         </div>	«↓»	Display the remaining capacity.
<div style="border: 1px solid black; padding: 5px;">           + 8,58962 9            I= 3,4770 9         </div>	«↓»	Display the individual components.
<div style="border: 1px solid black; padding: 5px;">           + 8,58962 9            STO 2 RES INF         </div>	«esc»	Exit the Info display.

Clear the measurements:

<div style="border: 1px solid black; padding: 5px;">           + 8,58962 9            STO 2 RES INF         </div>	«↑»	Hold down the key until the acoustic signal sounds and the component counter is reset.
<div style="border: 1px solid black; padding: 5px;">           + 8,58962 9            STO 0 RES INF         </div>		Measurements cleared, balance is ready for a new measurement.

A measurement log is printed by pressing the «PRINT» key.



## 9.8 Animal

### • SETUP APPLICATION







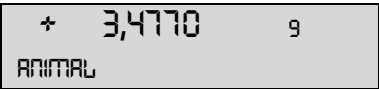

ANIMAL	MEASURETIME	4	<i>Enter time in seconds</i>
--------	-------------	---	------------------------------

With the aid of the „ANIMAL“ program you can weigh live animals accurately, even if they move on the weighing pan.

The balance measures continuously throughout the period defined by the user in the Setup menu, averages the stored values at the end of the measuring period and displays average-measurement thus obtained.

#### Assignment of the function keys:

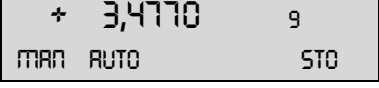
Key	Function
«MAN»	Manual release of the measurement.
«AUTO»	Automatic release of the measurement with a second delay after each load change.
«STO»	Statistics storage function if activated.

Display	Key	Step
	«  »	<i>Press until „ANIMAL“ appears.</i>
	«  »	<i>Manual release of the measurement.</i>
	«  »	<i>Automatic release of the measurement with a second delay after each load change.</i>
		<i>Display the measurement result; the small circle in the display is active.</i>
	«  »	<i>Statistics storage function if activated</i>

The measurement result is printed by pressing the «PRINT» key.

# 10 Statistics

• SET STATISTIC			
STATISTIC	MODE	<b>OFF</b> STATISTIC RECORDER STAT./RECORDER	Statistics program off Statistics only Data storage only Statistics and storage
	COUNT	<b>100</b>	Number of values to be stored automatically (1..500).
	RECORDING	<b>MANUAL</b> TIMEBASE LOADCHANGE	With «STO i» function key on a time basis after every weight change
	TIMBASE	<b>2.0</b>	Time base for "storage" in seconds

**„MODE“**

In this function-field you may define whether only the statistics-program, only the storage-program or both programs simultaneously should be used.

**„COUNT“**

A number of measurements is laid down, after which automatic storage is to be terminated.

**„RECORDING“**

„MANUAL“: The «STO i» function key must be pressed for each value to be stored.

„LOADCHANGE“: The balance stores the measured value automatically after a load change.

„TIMEBASE“: The balance stores every value measured after a defined period (default: 2.0 seconds).

**„TIMEBASE“**

Definition of the time span for the recording of data in accordance with „RECORDING TIMEBASE“ (e.g. every 2.0 seconds).

<b>!</b> <b>NOTE</b>
In storing the first value a range of $\pm 50\%$ is determined. Subsequent values must be within this range otherwise an error message will be issued.

**Assignment of the function keys:**

Key	Function
«STO i»	Take value, start/stop of automatic recording
«AUTO i»	Automatic recording is running
«WAIT i»	Value not stabilized yet
«RES»	Before a new series of measurements the storage must be reset using «RES». The key must be held down until the acoustic signal sounds and the measurement counter is reset.
«END»	Permanently store data (only with recording activated)
«INF»	Change the display to the Info display. Displayed information: - „Average value (MEAN)“ - „Standard deviation (STDE.)“ - „Relative standard deviation (STDE.-%)“ - „Maximum (MAX.)“ - „Minimum (MIN.)“ - „Difference maximum - minimum (DIFF.)“ - „Total (TOTAL)“ - „Individual values“ Press «esc» to exit the Info display.

Display	+	3,4770	9
STATISTIC			

Key	Step
«  »	Press until „STATISTIC“ appears.

Display	Key	Step
	«←»	Record a stable measurement.
	«←»	Record a second measurement.
	«←»	Add further weights.
Retrieve the parameters:		
	«↓»	Show Info display. Average measurement
	«↓»	Standard deviation
	«↓»	Relative standard deviation
	«↓»	Maximum
	«↓»	Minimum
	«↓»	Difference
	«↓»	Total
	«↓»	Measurement 1
	«↓»	Measurement 2, etc.
	«esc»	Exit Info display.
Clear measurements:		
	«↑»	Hold down the key until the acoustic signal sounds and the measurement counter is reset.
		Measurement cleared, balance ready for new statistics.

A statistics log is printed by pressing the «**PRINT**» key.

## 11 Check-Weighing

• SET CHECK +/-			
CHECK +/-	MODE	<b>OFF</b> g PCS	<i>Check weighing off</i> <i>Check weighing for weights in grams</i> <i>Check weighing in pieces</i>
	NOM.	<b>100.000 g</b> 100 PCS	<i>Enter nominal weight in grams or</i> <i>enter nominal number for pieces</i>
	TOLERANCE	g PCS %	<i>Choose to set limits as weight</i> <i>in pieces or</i> <i>in percent of nominal</i>
	TO	<b>10000.0 g</b>	<i>Upper limit in grams</i>
	TO	100 PCS	<i>Upper limit in pieces</i>
	TOL. +	1.0000 %	<i>Upper limits in percent of nominal</i>
	TO	<b>10000.0 g</b>	<i>Lower limit in grams</i>
TO	100 PCS	<i>Lower limit in pieces</i>	
TOL.-	1.0000 %	<i>Lower limits in percent of nominal</i>	

With the aid of the „CHECK +/-“ program you can check each measurement for its agreement with a defined reference-value plus/minus allowable deviations.

- The four function keys are not active.
- In the display „+“, „-“ and „→II←“ are active.  
If „→II←“ lights up, the measured value lies within the specified tolerances.

 <b>NOTE</b>
As an accessory, a signal light is available for this type of display (see Accessories).

Display	Key	Step
		Press until „CHECK +/-“ appears. The check application is activated.

## 12 User profiles

10 different user profiles can be saved. They can be protected against changes by means of a personal 4-digit password. A profile consists of the configuration and application settings.

Anyone who does not wish to create a personal user profile can work with the balance as a "guest". The settings from the last user profile used are applied. If a "guest" works with the balance, device options and settings can be changed, although they are not saved when the balance is switched off.

• SET USER		
USER	ttt...	User name
NEW PASSWORD	----	Enter user password
CLEAR USER		Clear active user

### 12.1 Activating a user

- Press «ON/OFF» to switch on the balance.
- Hold down «C» constantly during the start-up process (approx. 10 seconds) until „NEW USER“ appears in the display.
- A new user can be selected by pressing the «↵» key. The balance completes start-up and switches to Weighing mode.

### 12.2 Creating a new user profile

If no user profile has yet been defined, the balance can be used normally. In order to work with different user configurations, Work with Users must first be activated.

Display	Key	Step
+ 0,00000 9	«MENU»	Start the application menu.
----- SET APP. OFF	«↑»	Press repeatedly, until „SET USER“ is displayed.
----- SET USER	«⇒»	Switch into the user identification menu options.
----- USER	«↵»	Activate the user name entry and enter the required name using the cursor keys. A user name may be up to 20 characters long.
----- USER EXAMPL E	«↵»	Confirm the entry.
----- NEW PASSWORD ----	«↓»	If you wish, protect the user settings with a four-digit password.
----- NEW PASSWORD 0 0 0 0	«↵»	The first digit of the password flashes and can be changed.
----- NEW PASSWORD 8 0 0 0	«↑» «↓»	Press until the first digit in the password is set.
----- NEW PASSWORD 8 0 0 0	«⇒»	The second digit flashes. The password can now be entered fully.
----- NEW PASSWORD 8 2 3 5	«↵»	Confirm the password.

## ■ 12 User profiles

The user is defined. Press «**esc**» to exit the menu.

If there is a password set, it must be entered before making changes in the configuration and application menus.



### NOTE

Make a note of your **personal password**.

If a user loses his password, he can be enabled again using the password **7 9 1 4**.

This password is the same for all balances and is always valid in parallel to the password which the user has selected.

## 12.3 Changing the password and password protection

- The password can be entered by entering a new password.
- Password protection can be disabled by resetting the current password to **0 0 0 0**.

## 12.4 Clearing a user

A user can be cleared by selecting the „CLEAR USER“ option in the menu and pressing «**↵**» to confirm this entry.

If no further users are defined, Work with Users must be activated again in order to facilitate work with users.

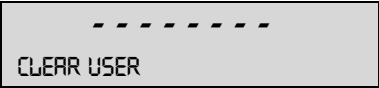
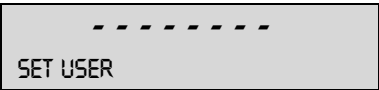
Display	Key	Step
	« <b>↓</b> »	Select the „CLEAR USER“ menu option.
	« <b>↵</b> »	The active user is cleared.

## 12.5 Setting the user

When the balance is started up, the system asks for the desired user profile.

Display	Key	Step
	« <b>↑</b> » « <b>↓</b> »	Select the desired user profile and press the « <b>↵</b> » key to confirm.

- If one of the defined user profiles is selected, the corresponding user password must be entered, where necessary. The user can then work with the balance.
- If „USER GUEST“ is selected, any available settings can be defined, although they are not saved.
- If „USER NEW“ is selected, the user name and the password must be entered in the application menu in order to define the user profile.

## 13 Data transfer

For data-transfers to peripheral devices, the balance is equipped with an RS232/V24-interface.

Before the data-transfer, the RS232 interface must be matched with the one in the peripheral device in the balance configuration menu (see chapter 8.3.7 "Interface functions").

- **Handshake**

The handshake is set to „NO“ (none) at the factory. It can be set to software handshake „XON-XOFF“, or to hardware handshake „HARDWARE“.

- **Baud rate**

Possible baud rates: 300, 600, 1200, 2400, 4800, 9600, 19200 baud.

- **Parity**

Possible parity: 7 even 1 stop, 7 odd 1 stop, 7 No 2 stop, 8 No 1 stop.

± 12 V	SB	1	2	3	4	5	6	7	8	SP
7-even-1	SB	1.DA	2.DA	3.DA	4.DA	5.DA	6.DA	7.DA	PB	SP
7-odd-1	SB	1.DA	2.DA	3.DA	4.DA	5.DA	6.DA	7.DA	PB	SP
7-no-2	SB	1.DA	2.DA	3.DA	4.DA	5.DA	6.DA	7.DA	1.SP	2.SP
8-no-1	SB	1.DA	2.DA	3.DA	4.DA	5.DA	6.DA	7.DA	8.DA	SP

SB: Start bit                      PB: Parity bit  
DA: Data bit                      SP: Stop bit

- **Display**

S	D7	D6	D5	D4	D3	D2	D1	D0	U	U	U
---	----	----	----	----	----	----	----	----	---	---	---

The data-transfer takes place in ASCII code:

1	2	3	4	5	6	7	8	9	10	11	12	13	14	15	...	...	...
B	B	B	S	D7	D6	D5	D4	D3	D2	D1	DP	D0	B	U	...	CR	LF

**B**            Blank (space)  
**S**            Sign (+, -, space)  
**DP**         Decimal point  
**D0...D7**   Digits  
**U ...**      Unit (only if the weight is stable, otherwise no unit is send)  
**CR**         Carriage return  
**LF**         Line feed



### NOTE

Unused positions are filled with spaces.  
The decimal point DP can be between D0 and D7.

### 13.1 Connection scheme

- **Standard, duplex connection including lines for optional hardware handshake with the peripheral device**

Balance	RJ 45	D25 / D9	Peripheral device
RS 232 in	6 ←	2 / 3	RS 232 out
GND	5	7 / 5	GND
CTS	3 ←	20 / 4	DTR (only need for hardware handshake)
DTR	7 →	5 / 8	CTS (only need for hardware handshake)

## ■ 13 Data transfer

### • Pin configuration of the RJ45 socket

Balance	RJ 45	Remark
n.c.	1	not connected
RS 232 out	2	Out (V24)
CTS	3	In (V24)
VDC	4	Out (9..16V)
GND	5	0V
RS 232 in	6	In (V24)
DTR	7	Out (V24)
EXTBUS	8	In (5V, logic)

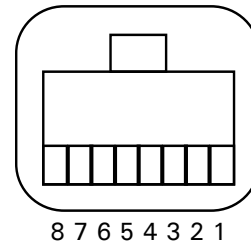

## 13.2 Remote control-commands

Command	Function
ACKn	Acknowledge n=0 off; n = 1 on
CAL	Start calibration
D.....	Describe weight display (right-aligned)
DN	Reset weight display
@.....	Describe Info display
@N	Reset Info display
In	Set FLOATINGDISPLAY time nn = 0      t = 0.04 s n = 1      t = 0.08 s n = 2      t = 0.16 s n = 3      t = 0.32 s
N	Reset balance
OFF	Switch off balance
ON	Switch on balance
PCxxxx	Enter anti-theft code
PDT	Print out date and time
PRT	Start printing (Press « <b>PRINT</b> » key)
PST	Start print status
Pn (ttt.t)	Set print mode n = 0 Individually print each value (unstable) n = 1 Individually print each value (stable) n = 2 Print after change of load n = 3 Print after each integration period n = 4 Print on time basis in s (ttt.t)
R%k	Set current weight = 100% with k=0...7 decimal places (k=A: use automatic positioning of decimal point)
REF%k rrr	Set reference weight rrr for 100% with k=0...7 decimal places (k=A: use automatic positioning of decimal point)
Rnnn	Set current weight = nnn items
REFrrr	Set reference weight rrr for 1 item
Sn	Set stability n                      n = 0 low n = 1 medium n = 2 high
SDTttmmjj hmmss	Set date and time (German) (Tag, Monat, Jahr, Stunde, Minute, Sekunde)
SDTmmddy hmmss	Set Date and Time (English) (Month, Day, Year, Hour, Minutes, Seconds)
T (ttt)	Tare or set tare to a specific value
Uxnn	Set unit x (1...4) of the balance with nn (0=g, 1=mg, 2=kg, ...)
UxS	Switch balance to unit x (1...4)



Command	Function
ZERO	Zero balance (provided weight is stable and within the zero position range)

**NOTE**

Each remote control-command must terminate with «CR» «LF».  
The commands are acknowledged if required.

**13.2.1 Examples for the remote control**

Input	Description of the function executed
D - - - - -	Five dashes are displayd
DTEST123	tESt123 is displayd
D	The display is dark
T100	-100.000 g (Tare set to 100 g)
T1	-1.000 g (Tare set to 1g)
T	Balance is tared

## 14 Service

### 14.1 Maintenance and servicing

The balance must be treated carefully and cleaned regularly. It is a precision instrument.

#### DANGER

For maintenance work, the balance must be separated from the power supply (remove power adaptor plug from socket). Also ensure that the balance cannot be reconnected to the power supply during the work by a third party.

Take care during cleaning that no liquid penetrates into the appliance. If liquid is spilt on the balance, the latter must immediately be disconnected from the electricity supply. The balance must only be used again after it has first been checked by a Service Engineer.

The connections on the rear of the appliance and the power adaptor must not come into contact with liquids.

Regularly dismantle the weighing pan and the weighing pan holder and remove any dirt or dust from under the weighing pan and on the balance housing with a soft brush or a soft, lint-free cloth, moistened with a mild soap solution.

The weighing pan and the holder can be cleaned under running water. Take care that both parts are completely dry before they are re-installed on the balance.

#### CAUTION

Never use solvents, acids, alkalis, paint thinners, scouring powders or other aggressive or corrosive chemicals for cleaning, since these substances attack the surfaces of the balance housing and can cause damage.

The regular maintenance of the balance by your Service Representative will guarantee unlimited function and reliability over many years and will extend the lifespan of the balance.

### 14.2 Error messages

The balance shows a description of the fault in the Info display.

#### NOTE

If an error occurs without a description of the error in the Info display, the Customer Service must be called.

#### 14.2.1 Notes on correcting faults

The following table shows faults and their possible causes. If you cannot clear the fault using the table, please contact the Customer Service..

Fault	Possible cause
Weight display does not light	<ul style="list-style-type: none"> <li>• Balance not switched on</li> <li>• Connection to power adaptor is interrupted</li> <li>• Power supply has failed (interruption to current)</li> <li>• The power adaptor is defective</li> </ul>
"OL" is shown in display	<ul style="list-style-type: none"> <li>• The weight range has been exceeded (Observe information on the maximum weight range)</li> </ul>
"UL" is shown in display	<ul style="list-style-type: none"> <li>• The weight range is below the range of the balance (Scale pan or scale pan holder missing)</li> </ul>

Fault	Possible cause
The weight display fluctuates continuously	<ul style="list-style-type: none"> <li>• The draft is too strong at the balance location</li> <li>• The balance support is vibrating or varying</li> <li>• The scale pan is touching a foreign body</li> <li>• The time chosen for FLOATINGDISPLAY is too short</li> <li>• The material being weighed is absorbing moisture</li> <li>• The material being weighed is being blown away or is evaporating</li> <li>• Strong temperature variations in the material being weighed</li> </ul>
Results of weighing are clearly incorrect	<ul style="list-style-type: none"> <li>• The balance was not correctly tared</li> <li>• The balance is not correctly levelled</li> <li>• The calibration is no longer correct</li> <li>• There are strong temperature variations</li> </ul>
There is no display or only dashes	<ul style="list-style-type: none"> <li>• The stability control (Balance functions) is set too sensitively</li> <li>• The time selected for „FLOATINGDISPLAY“ is unsatisfactory</li> </ul>
Configuration menu cannot be changed	<ul style="list-style-type: none"> <li>• The password lock is activated in the configuration menu</li> </ul>
The display flashes continuously during calibration	<ul style="list-style-type: none"> <li>• The balance location is not stable enough (Interrupt calibration with «ON/OFF» and relocate the balance in a better position)</li> <li>• Use of an imprecise calibration weight (only applies to external calibration)</li> </ul>

## 14.3 Calibration

The calibration of the balance is fixed in the Configuration menu (see chapter 7.7 "Calibration of the balance" and see chapter 8.3.5 "Calibration functions").

Possible types of calibration, depending on the model of balance:

- External calibration by means of ICM (Intelligent Calibration Mode)
- External calibration with freely selectable weight
- Internal calibration
- Automatic calibration

### ! NOTE

The calibration can be interrupted at any time by pressing «ON/OFF».

### 14.3.1 External calibration by means of ICM

Depending on the type of balance, calibration weights in steps of 10 g, 50 g, 100 g and 500 g can be used, where the calibration weight must correspond to the precision of the balance.

For an external calibration by means of ICM, „SET CALIBRATION MODE EXTERNAL“ must be selected in the Configuration menu (see chapter 8.3.5 "Calibration functions").

Display	Key	Step
		<i>The balance is in Weighing mode.</i>
	«T»	<i>Press until „CALIBRATION“ appears.</i>
		<i>The balance carries out a Zero measurement „0000 g“ is shown flashing.</i>

## ■ 14 Service

Display	Key	Step
		After the zero measurement the display flashes with the recommended calibration weight.
		Place the calibration weight on the weighing pan. The display continues to flash.
		Calibration is complete when the display stops flashing

### 14.3.2 External calibration with freely selectable weight

For external calibration with user-definable weight, „SET CALIBRATION MODE EXT. -DEF.“ must be selected in the Configuration menu (see chapter 8.3.5 "Calibration functions").

Then, the effective value of the calibration weight (DEF. n.nnn g) must be entered with up to tenfold precision compared with the balance.

#### ! NOTE

If calibration is carried out with the free weight, then only this weight may be used.

Then proceed as follows:

Display	Key	Step
		The balance is in Weighing mode.
	«T»	Press until „CALIBRATION“ appears.
		The balance carries out a Zero measurement „0000 g“ is shown flashing).
		After the zero measurement the display flashes with the previously entered calibration weight.
		Place the calibration weight. The display continues to flash.
		Calibration is complete when the display stops flashing

### 14.3.3 Internal calibration

For internal calibration with the built-in calibration weight „SET CALIBRATION MODE INTERNAL“ must be selected in the Configuration menu (see chapter 8.3.5 "Calibration functions").

Then proceed as follows:

- Switch to „WEIGHING“ with the Change key
- Press «T» until „CALIBRATION“ is shown.
- Calibration is finished after a certain period of time

### 14.3.4 Automatic calibration

For automatic calibration with the built-in calibration weight „SET CALIBRATION MODE AUTO“ must be selected in the Configuration menu (see chapter 8.3.5 "Calibration functions").

The balance now calibrates itself automatically every 24 hours and/or after each temperature change of 3 degrees Celsius, depending on the definition in the Configuration menu „SET CALIBRATION MODE AUTO“.

The time of the automatic calibration is as determined in the Configuration menu under „SET CALIBRATION

AUTOCAL. -TIME n h". (e.g. 6 h for 06.00 o'clock in the morning)

### ! NOTE

For automatic calibration by time and by time/temp. the date and time of the balance must first be correctly set (see chapter 8.3.8 "Date and time").





Calibration can also be effected manually at any time when auto-calibration is activated.

Automatic calibration then takes place only if no weight has been placed on the pan for at least five minutes.

It is recommended that the time for auto-calibration be set outside the normal business hours (for example, in the early morning).

## 14.4 Automatic Repeatability Test (ART)

During the Automatic Repeatability Test, the internal weight is measured 10 times, and the standard deviation is calculated from this and logged.

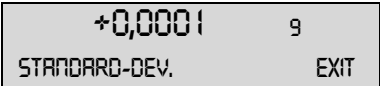
Display	Key	Step
		<i>The balance is in Weighing mode.</i>
	«T»	<i>Press until „REPEATABILITY TEST“ appears.</i>
		<i>The internal weight is applied and measured. 10 measurements are performed.</i>
	«↓»	<i>If required, the measuring program can be exited.</i>
		<i>The standard deviation of the measurement is calculated and displayed as a result, and the log is printed.</i>

## 14.5 Software update

Our balances are continuously developed and improved. Therefore you can download the latest version of the instrument firmware from the Internet.

To update the firmware, you must download the Universal Download Tool from the website and install it onto your Windows PC.

The firmware of the balance can also be downloaded from the download section of the website and downloaded to the scale using the Universal Download Tool.

# 15 Menu trees

## 15.1 Configuration menu tree

<b>• UNIT-1</b>	
UNIT-1	g mg kg ... Bht
<b>• SET DATA PRINT</b>	
	AUTOSTART ON/OFF
	MODE UNSTABLE <b>STABLE</b> LOADCHANGE CONTINUOUS TIMEBASE
	TIMEBASE 2.0
	SET PRINTFORMAT DATE AND TIME ON/OFF BALANCE-ID ON/OFF PRODUCT-ID ON/OFF GROSS AND TARE ON/OFF UNITS ON/OFF USER ON/OFF LINEFEED OFF/1/2/..9/FORMFEED
	PRODUCT ttt...
	PRODUCTMODE <b>HOLD</b> DELETE COUNT
	PRODUKT INFO OFF/ON
<b>• SET CALIBRATION</b>	
	MODE OFF EXTERNAL EXT.-DEF. <b>INTERNAL</b> AUTO
	DEF. 0.000 g
	AUTOCAL. TIME/TEMP. TEMPERATURE TIME
	AUTOCAL.-TIME 6 h
<b>• SET WEIGHING MODE</b>	
	FLOATINGDISPLAY 0.04 0.08 <b>0.16</b> 0.32
	STABILITY LOW <b>MEDIUM</b> HIGH
	AUTO-STANDBY OFF 0.5 MIN 1 MIN 5 MIN 10 MIN
	AUTO-ZERO ON/OFF
	QUICK-TARA ON/OFF
	ZERO-RANGE 0.0 g

• SET INTERFACE							
	<table border="1"> <tr> <td>MODE</td> <td><b>STANDARD</b> PC DIRECT HID</td> </tr> <tr> <td>ZEICHENSATZ</td> <td><b>ENG</b> DEU FRA</td> </tr> <tr> <td>FORMAT</td> <td><b>LINES</b> TABEL</td> </tr> </table>	MODE	<b>STANDARD</b> PC DIRECT HID	ZEICHENSATZ	<b>ENG</b> DEU FRA	FORMAT	<b>LINES</b> TABEL
MODE	<b>STANDARD</b> PC DIRECT HID						
ZEICHENSATZ	<b>ENG</b> DEU FRA						
FORMAT	<b>LINES</b> TABEL						
	<table border="1"> <tr> <td>BAUDRATE</td> <td>300 600 1200 2400 4800 <b>9600</b> 19200</td> </tr> <tr> <td>PARITY</td> <td><b>7-EVEN-1STOP</b> 7-ODD-1STOP 7-NO-2STOP 8-NO-1STOP</td> </tr> <tr> <td>HANDSHAKE</td> <td><b>NO</b> XON-XOFF HARDWARE</td> </tr> </table>	BAUDRATE	300 600 1200 2400 4800 <b>9600</b> 19200	PARITY	<b>7-EVEN-1STOP</b> 7-ODD-1STOP 7-NO-2STOP 8-NO-1STOP	HANDSHAKE	<b>NO</b> XON-XOFF HARDWARE
BAUDRATE	300 600 1200 2400 4800 <b>9600</b> 19200						
PARITY	<b>7-EVEN-1STOP</b> 7-ODD-1STOP 7-NO-2STOP 8-NO-1STOP						
HANDSHAKE	<b>NO</b> XON-XOFF HARDWARE						
• SET DATE AND TIME							
	<table border="1"> <tr> <td>TIME</td> <td>[HH.MM.SS]</td> </tr> <tr> <td>DATE</td> <td>[DD.MM.YY]</td> </tr> <tr> <td>FORMAT</td> <td><b>STANDARD/US</b></td> </tr> </table>	TIME	[HH.MM.SS]	DATE	[DD.MM.YY]	FORMAT	<b>STANDARD/US</b>
TIME	[HH.MM.SS]						
DATE	[DD.MM.YY]						
FORMAT	<b>STANDARD/US</b>						
• MENU LOCK							
MENU LOCK	<table border="1"> <tr> <td>SET MENU</td> <td><b>OFF</b> CONF. CONF. + APP.</td> </tr> <tr> <td>NEW PASSWORD</td> <td>-----</td> </tr> </table>	SET MENU	<b>OFF</b> CONF. CONF. + APP.	NEW PASSWORD	-----		
SET MENU	<b>OFF</b> CONF. CONF. + APP.						
NEW PASSWORD	-----						
• THEFTCODE							
THEFTCODE	<table border="1"> <tr> <td>THEFT-PROTECTION</td> <td><b>OFF/ON</b></td> </tr> <tr> <td>NEW CODE</td> <td>-----</td> </tr> </table>	THEFT-PROTECTION	<b>OFF/ON</b>	NEW CODE	-----		
THEFT-PROTECTION	<b>OFF/ON</b>						
NEW CODE	-----						
• KEY TONE							
KEY TONE	<b>ON/OFF</b>						
• TON							
TONE	SOUND 1 SOUND 2 <b>SOUND 3</b> SOUND 4 SOUND 5						
• BUS							
BUS	<b>ON/OFF</b>						
• LANGUAGE							
	<table border="1"> <tr> <td>LANGUAGE</td> <td><b>ENGLISH</b></td> </tr> <tr> <td>SPRACHE</td> <td>DEUTSCH</td> </tr> <tr> <td>LANGUE</td> <td>FRANCAISE</td> </tr> </table>	LANGUAGE	<b>ENGLISH</b>	SPRACHE	DEUTSCH	LANGUE	FRANCAISE
LANGUAGE	<b>ENGLISH</b>						
SPRACHE	DEUTSCH						
LANGUE	FRANCAISE						

## 15.2 Application menu tree

<b>• SET APP.</b>	
	OFF
	UNITS
	COUNT
	PERCENT
	CALCULATOR
	PAPER
	NET-TOTAL
	SUM
	ANIMAL
	etc.

*Other applications available.  
Refer to the Application Operating Instructions for the description.*

<b>• SETUP APPLICATION</b>	

*Division depends on the current application.  
(see chapter 8.5 "Application menu")*

<b>• SET STATISTIC</b>	

MODE	OFF
	STATISTIC
	RECORDER
	STAT./RECORDER
COUNT	100
RECORDING	MANUAL
	TIMEBASE
	LOADCHANGE
TMEBASE	2.0

<b>• SET CHECK +/-</b>	

MODE	OFF
	g
	PCS
NOM.	10000 g
	100 PCS
TOLERANCE	g
	PCS
	%
TO	12000 g
TO	100 PCS
TOL. +	1.0000 %
TU	8000 g
TU	100 PCS
TOL.-	1.0000 %

<b>• AUTO-START</b>	
AUTO-START	ON/OFF

<b>• SET USER</b>	
USER	ttt...
NEW PASSWORD	- - - -
CLEAR USER	